

CHIAYO

Operation manual

LECTERN PRO

Multifunctional Wireless Lectern Amplifier

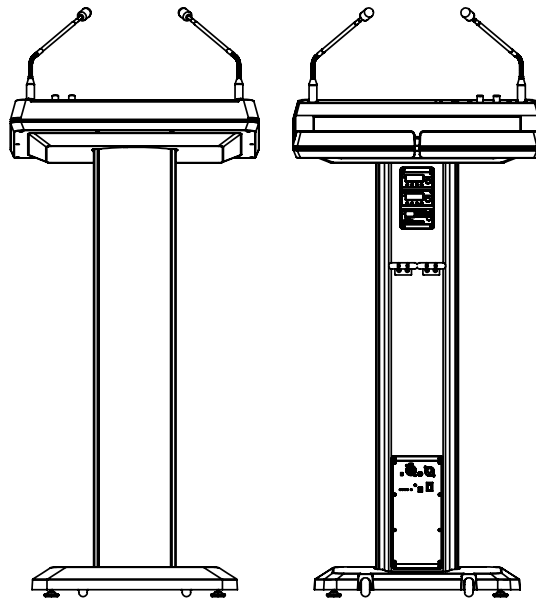

CHIAYO ELECTRONICS CO., LTD.

LECTERN PRO Multifunctional Wireless Lectern Amplifier

Important safety instructions

- Read all of the instructions before the product is operated.
- Keep these instructions well for future reference.
- Follow all of the warnings and instructions when installing, setting up and using the product.
- Only clean the product when it is not connected to the power supply system. Clean only with a dry cloth.
- Keep ventilation openings unblocked and follow with the manufacturer's instructions for installation.
- Do not immerse product in any liquid or expose to heat or moisture
- Keep the complete polarized or grounding type plug without any modification. A polarized plug has two blades with one wider than the other. A grounding type plug has two blades and a third grounding prong. The wider blade or the third prong are provided for your safety. If the provided plug does not fit into your outlet, consult an electrician for replacement of the obsolete outlet.
- Power supply cords should be well routed to prevent from being walked on or pinched by items placed upon or against them, particularly at plugs, convenience receptacles, and the point where they exit from the product.
- Use only manufacturer authorized or recommended accessories.
- Use only with a cart, stand, tripod or accessories specified or provided by Chiayo. Be careful when using a cart to avoid injury from tip-over.
- Unplug the product during an electrical storm or when unused for long periods of time.
- Never disassemble, modify or service the product. Any unauthorized modifications may result in personal injury and/or product failure. Additionally, your warranty will be void.
- Please read and follow the instructions in this manual thoroughly to obtain optimum results from this unit. We also recommend that you keep this manual handy for future reference.



Warning

Please read and follow the instructions in this manual thoroughly to obtain optimum results from this unit. We also recommend that you keep this manual handy for future reference.

Safety Precautions



- Be sure to read the instructions in this section carefully before use.
- Make sure to observe the instructions in this manual as the conventions of safety symbols and messages regarded as very important precautions are included.

Safety symbols and messages described below are used in this manual to prevent bodily injury and property damage which could result from mishandling. Before operating your product, read this manual first and understand the safety symbols and messages so you are thoroughly aware of the potential safety hazards.

	WARNING	Indicates a potentially hazardous situation which, if mishandled, could result in death or serious personal injury.
	CAUTION	Indicates a potentially hazardous situation which, if mishandled, could result in moderate or minor personal injury, and/or property damage.

Make sure to observe the following handling precautions so that a fire or personal injury does not result from leakage or explosion of the battery.

- Do not short, disassemble, heat or put the battery into a fire.
- Never charge batteries of the type which are not rechargeable.
- Do not solder a battery directly.
- Be sure to use the specified type of battery.
- Note the correct polarity when inserting a battery in the unit.
- Avoid locations exposed to the direct sunlight, high temperature and high humidity when storing batteries.

	WARNING	To prevent the electromagnetic wave from badly influencing medical equipment, make sure to switch off the unit's power when placing it in close proximity to the medical equipment.
	CAUTION	Battery discharge naturally according to a certain pattern even not in use. For best performance and a prolonged lifespan, battery should be charged regularly after every use or every three months when the system is in storage and not being used! CD player optical pick up head is a very delicate device and sensitive to humidity. Please avoid using it in high humidity area to avoid damage!

LECTERN PRO Multifunctional Wireless Lectern Amplifier

INDEX

1. Instruction4

 1-1. In the box.....4

 1-2. Optional related products4

 1-3. Parts and functions.....5

 1-4. Charging the battery.....6

 1-5. Module compartment.....7

 1-6. Connection with external audio sources7

2. Settings and Operations8

 2-1. Using the gooseneck microphone8

 2-2. Using the wireless receiver.....9

 2-2-1. Parts and functions.....9

 2-2-2. Channel synchronization of the receiver and transmitter9

 2-2-3. Channel scanning10

 2-2-4. Squelch (SQ) setting10

2-2-5. Volume setting.....11
 2-3. Using the wired microphone (INPUT).....12
 2-4. Using external audio (INPUT).....13
 2-5. Music audio input (LINE IN)- Laptop / Smart phone / tablet14
 2-6. Operating Bluetooth receiver (BLUETOOTH).....15
 3. Application16
 3-1. Active audio link: LECTERN PRO to active speaker16
 4. Installing or replacing a receiver/repeater/MP3 module17
 5. FAQ & useful operation tips.....18
 6. Maintenance-free Lead-acid and Lithium batteries20

1. Instruction

Congratulations and thank you for purchasing this all-in-one lectern sound system. To ensure a trouble-free operation, please read the manual thoroughly to fully understand its controls and functions.

The lectern sound system is divided into 3 sections:

1. Audio inputs and controls
2. Module compartment
3. Other audio inputs, outputs, control and battery compartment.

The Modules Compartment can be user configurable and user can access the battery compartment to change battery.

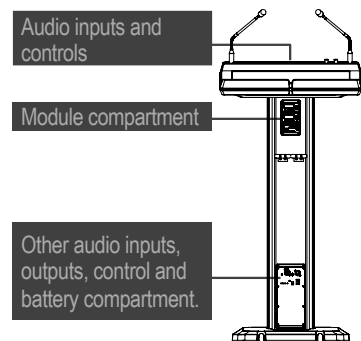

1-1. In the box

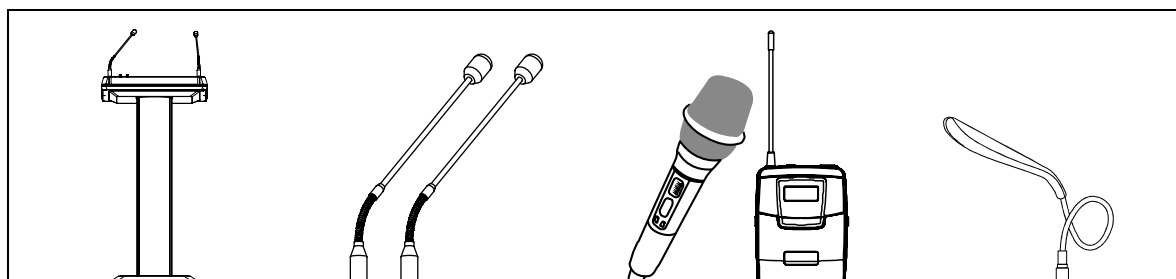

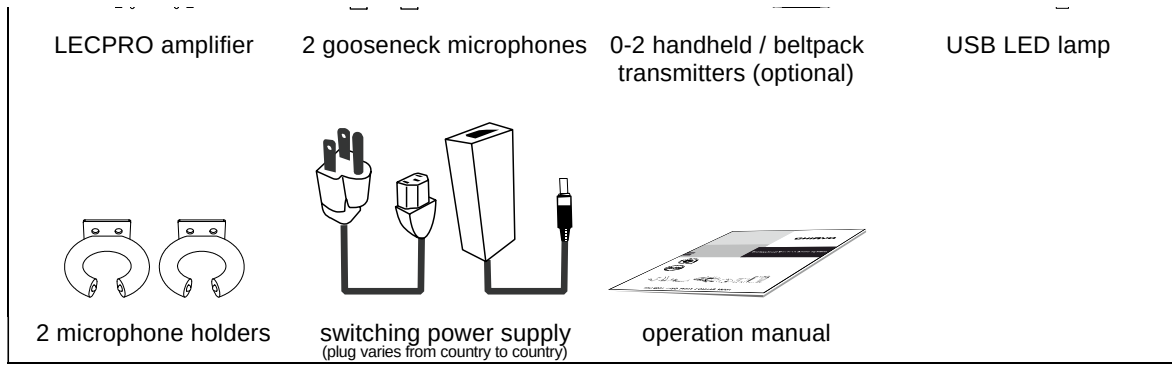

1-2. Optional related products

Modules & transmitters

SDR-8200M IrDA	UHF 2-Way Sync True Diversity Receiver Module	SQ-6100 IrDA	Rechargeable Handheld Wireless Microphone
		SQ-5100 IrDA	
DPR-500m	MP3 Recorder Player Module	SM-6100 IrDA	Rechargeable Belt-pack Transmitter

Accessories

USB LED lamp		DM-series	Wired microphone, please refer to CHIAYO website.
--------------	--	-----------	--

4

Instruction

1-4. Charging the battery

This amplifier uses one lithium battery. The battery power is leveled from 25%, 50%, 75% and FULL. If the LED stays at 50%, the battery might not be sustainable for long operation.

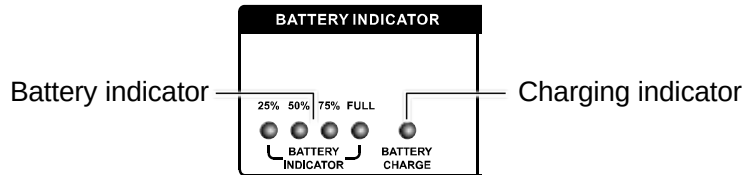

Charging indicator	Condition
Flashes RED	During recharging
Solid GREEN	Fully charged
Solid YELLOW	Error or no battery detected

LECTERN PRO Multifunctional Wireless Lectern Amplifier

1-5. Module compartment

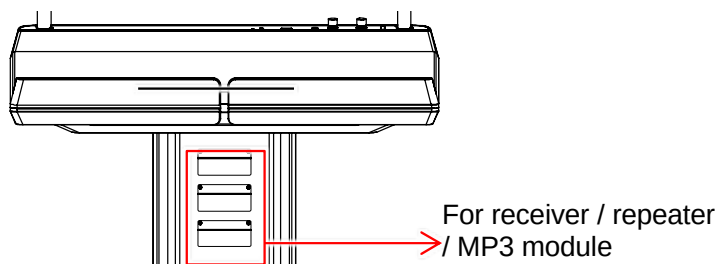

1-6. Connection with external audio sources

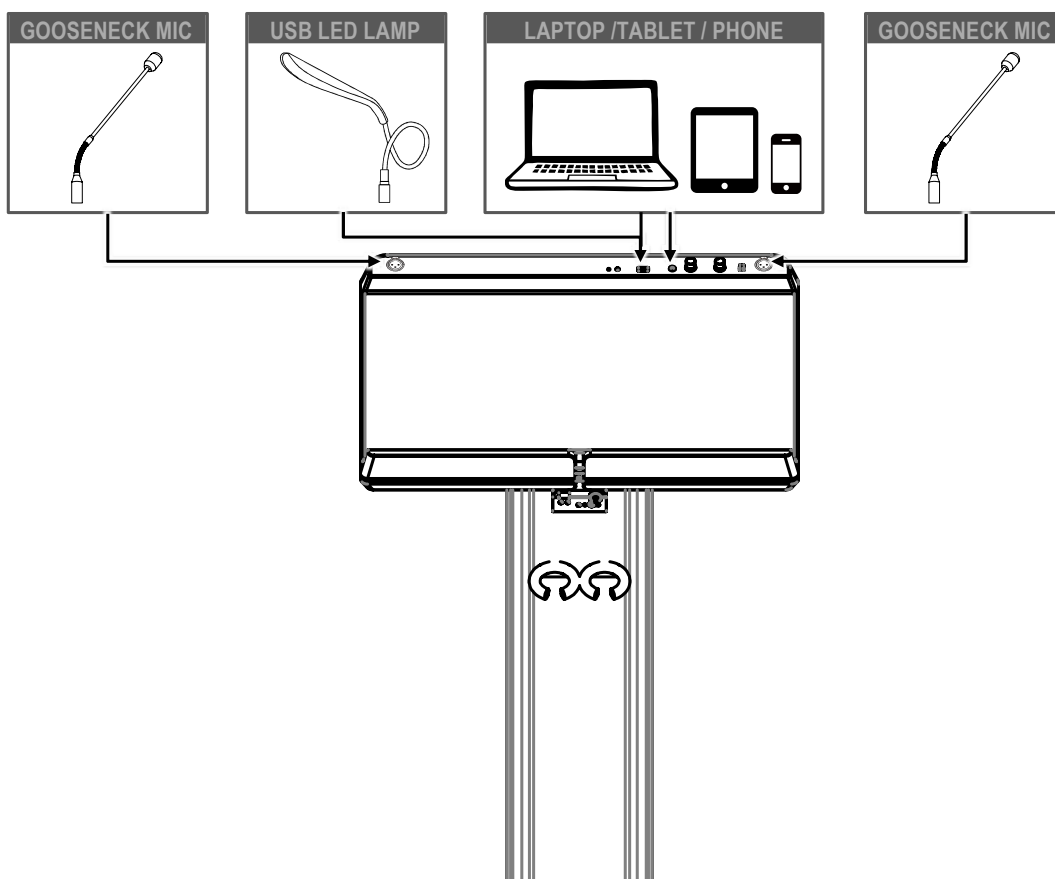

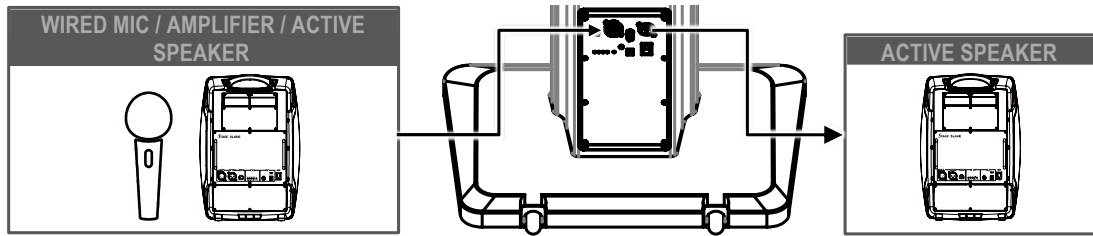

7

2. Settings and Operations

2-1. Using the gooseneck microphone

1 Plug two gooseneck microphones to the XLR jacks on both sides.

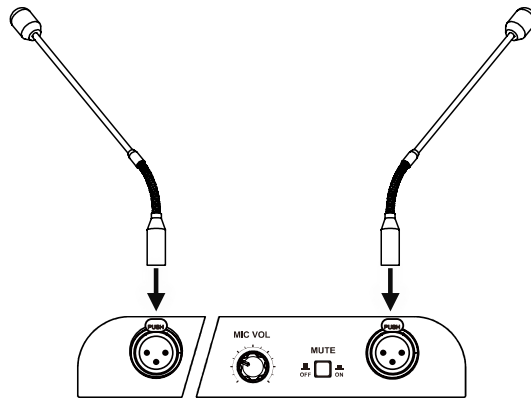

2 Turn on master power and then adjust the **MIC VOL** to set both microphones to a desired volume level.

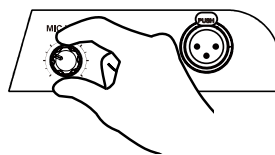

3 The MUTE push switch can disable and enable talking to the microphone.

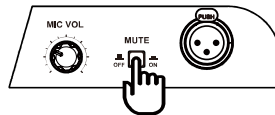

 → Muted and talking disabled

 → Talking enabled

LECTERN PRO Multifunctional Wireless Lectern Amplifier

2-2. Using the wireless receiver

2-2-1. Parts and functions

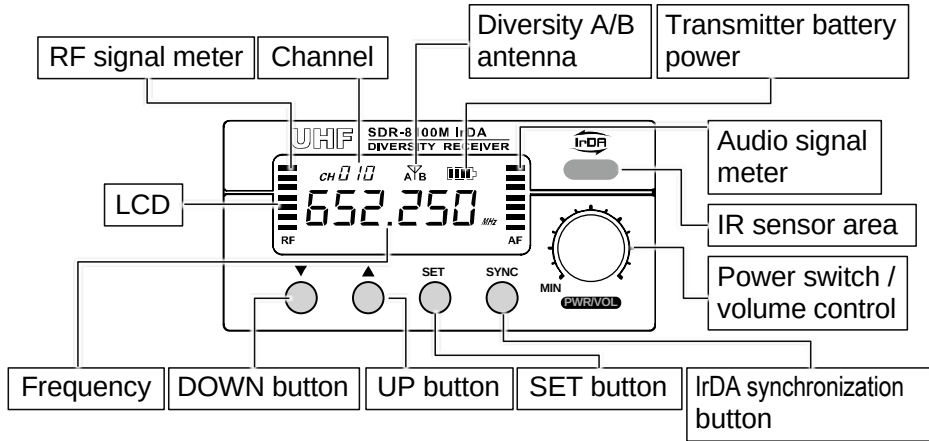

2-2-2. Channel synchronization of the receiver and transmitter

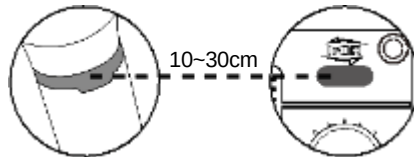

Align infrared areas of the receiver and transmitter within 10~30cm.

■ Changing receiver's channel

- 1** Press the synchronization button of the transmitter.

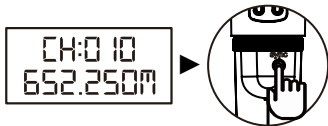

- 2** The transmitter's LED will glow to denote synchronization signal transmitted.



- 3** The channel number on the receiver's LED will become the same as the transmitter's, which means the receiver has been successfully synchronized.

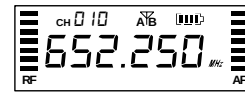

■ Changing transmitter's channel

- 1** Press the SYNC button of the receiver.

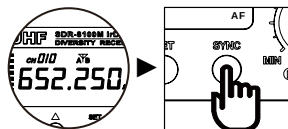

- 2** The transmitter's LED will glow to denote synchronization signal received.



- 3** The channel number on the transmitter's LCD will become the same as the receiver's, which means the transmitter has been successfully synchronized.



If it doesn't work check that you have the IR sensor panels aligned, that they are facing each other, devices are within 10~30cm of each other, and try again.