

PRODUCT MANUAL

ABB i-bus[®] KNX

SAH/S x.x.7.1

Switch/Shutter Actuator



Table of contents

1	About this document	8
1.1	Using the product manual	8
1.2	Legal disclaimer	8
1.3	Explanation of symbols	8
2	Safety	10
2.1	General safety instructions.....	10
2.2	Qualification of the specialist personnel.....	10
2.3	Proper use	10
3	Product overview	11
3.1	Device description	11
3.1.1	Membrane keypad.....	11
3.2	Product name description	11
3.3	Ordering details	12
3.4	Connections	12
3.4.1	Inputs	12
3.4.2	Outputs	12
3.5	Switch/Shutter Actuator SAH/S 8.6.7.1, 8-fold, 6 A, MDRC.....	13
3.5.1	Dimension drawing	14
3.5.2	Connection diagram	15
3.5.3	Operating and display elements	16
3.5.4	Technical data	18
3.6	Switch/Shutter Actuator SAH/S 16.6.7.1, 16-fold, 6 A, MDRC	21
3.6.1	Dimension drawing	22
3.6.2	Connection diagram	23
3.6.3	Operating and display elements	24
3.6.4	Technical data	26
3.7	Switch/Shutter Actuator SAH/S 24.6.7.1, 24-fold, 6 A, MDRC	29
3.7.1	Dimension drawing	30
3.7.2	Connection diagram	31
3.7.3	Operating and display elements	32
3.7.4	Technical data	34
3.8	Switch/Shutter Actuator SAH/S 8.10.7.1, 8-fold, 10 A, MDRC.....	37
3.8.1	Dimension drawing	38
3.8.2	Connection diagram	39
3.8.3	Operating and display elements	40
3.8.4	Technical data	42
3.9	Switch/Shutter Actuator SAH/S 16.10.7.1, 16-fold, 10 A, MDRC	45
3.9.1	Dimension drawing	46
3.9.2	Connection diagram	47
3.9.3	Operating and display elements	48
3.9.4	Technical data	50
3.10	Switch/Shutter Actuator SAH/S 24.10.7.1, 24-fold, 10 A, MDRC	53
3.10.1	Dimension drawing	54
3.10.2	Connection diagram	55
3.10.3	Operating and display elements	56
3.10.4	Technical data	58
3.11	Switch/Shutter Actuator SAH/S 8.16.7.1, 8-fold, 16 A, MDRC	61
3.11.1	Dimension drawing	62
3.11.2	Connection diagram	63
3.11.3	Operating and display elements	64
3.11.4	Technical data	66
3.12	Switch/Shutter Actuator SAH/S 16.16.7.1, 16-fold, 16 A, MDRC	69
3.12.1	Dimension drawing	70
3.12.2	Connection diagram	71

3.12.3	Operating and display elements	72
3.12.4	Technical data	74
3.13	Switch/Shutter Actuator SAH/S 24.16.7.1, 24-fold, 16 A, MDRC.....	77
3.13.1	Dimension drawing	78
3.13.2	Connection diagram	79
3.13.3	Operating and display elements	80
3.13.4	Technical data	82
4	Function.....	85
4.1	Device functions.....	85
4.2	Software functions.....	85
4.2.1	Functional overview	85
4.2.2	Function diagram Shutter Actuator	86
4.2.3	Function diagram Switch Actuator.....	87
4.2.4	Safety functions.....	88
4.2.5	Function Logic	93
4.2.6	Function Threshold	94
4.2.7	Function Load shedding	95
4.2.8	Function Automatic sun protection	100
4.2.9	Function Scenes.....	102
4.2.10	Time functions	104
4.3	Integration into i-bus® Tool.....	108
4.4	Special operating states	108
4.4.1	Reaction on bus voltage failure	108
4.4.2	Reaction after bus voltage recovery.....	108
4.4.3	Reaction on ETS reset.....	109
4.4.4	Reaction during download	109
5	Mounting and installation.....	110
5.1	Information about mounting	110
5.2	Mounting on mounting rail	110
6	Commissioning.....	111
6.1	Prerequisites for commissioning	111
6.2	Commissioning overview	111
6.3	Putting device into operation	111
6.4	Assignment of the physical address.....	112
6.5	Software/application	112
6.5.1	Download reaction	112
6.5.2	Copying, exchanging and converting.....	112
7	Parameters.....	113
7.1	General	113
7.2	Parameter windows	114
7.2.1	Configuration	114
7.2.2	Device settings	117
7.2.3	Manual operation	118
7.2.4	Safety/Weather alarms	119
7.2.5	Logic/Threshold	121
7.2.6	Switch Actuator template.....	124
7.2.7	Shutter Actuator template	125
7.2.8	Shutter Actuator X+Y.....	126
7.2.9	Switch Actuator X.....	139
7.3	Overview of parameters	150
7.4	Parameter descriptions.....	154
7.4.1	Start-up delay.....	154
7.4.2	Number of Off/On changes	154
7.4.3	Number of flashing cycles	154

7.4.4	Number of slat adjustments/steps (from 0 % = open to 100 % = closed)	155
7.4.5	Application.....	155
7.4.6	Recall Scene x also via 1-bit Group Object.....	155
7.4.7	Output reacts to	157
7.4.8	Output reacts to wind alarm x.....	157
7.4.9	Output reacts to central shutter Group Objects	158
7.4.10	Disconnect output from power after	158
7.4.11	Enable output X + Y	159
7.4.12	Coasting delay	159
7.4.13	Delay for switching off.....	159
7.4.14	Automatic reset after	160
7.4.15	Automatic reactivation of Automatic sun protection	160
7.4.16	Automatic reset from manual operation to KNX operation	161
7.4.17	Blind/Shutter reaction on bus voltage failure.....	161
7.4.18	Blind/Shutter reaction on frost alarm	162
7.4.19	Blind/Shutter reaction on rain alarm	163
7.4.20	Blind/Shutter reaction on cancellation of weather alarm, block and forced operation.....	164
7.4.21	Blind/Shutter reaction on block.....	165
7.4.22	Blind/Shutter reaction on wind alarm	166
7.4.23	Monitor range between thresholds	167
7.4.24	Description	168
7.4.25	Operating mode	168
7.4.26	Flashing if Group Object "Flashing" is.....	169
7.4.27	Data point type of Group Object "Threshold input".....	169
7.4.28	Request Date/Time via Group Object.....	170
7.4.29	Duration for tensioning.....	170
7.4.30	Deactivation of Automatic sun protection	171
7.4.31	Block delay for switching on and off after bus voltage recovery	171
7.4.32	Block delay for switching on and off via Group Object	171
7.4.33	Read input Group Objects after bus voltage recovery and download	172
7.4.34	Duration of slat adjustment/step	173
7.4.35	Delay for switching on.....	173
7.4.36	Invert result.....	174
7.4.37	Result if upper threshold is exceeded.....	174
7.4.38	Result if lower threshold is dropped below	174
7.4.39	Limit travel range via Group Object.....	175
7.4.40	Travel time down	176
7.4.41	Travel time up.....	176
7.4.42	Function of the logic gate.....	176
7.4.43	Enable function Load shedding.....	178
7.4.44	Enable function Safety	178
7.4.45	Enable function Safety/Weather alarms	178
7.4.46	Enable function Automatic sun protection.....	179
7.4.47	Enable function Scenes [Shutter Actuator].....	179
7.4.48	Enable function Scenes [Switch Actuator]	179
7.4.49	Enable function Time.....	180
7.4.50	Total duration for slat turning from 0 % - 100 %.....	180
7.4.51	In period (0 = deactivated)	181
7.4.52	Enable Group Object "Block direct operation"	181
7.4.53	Enable Group Object "Frost alarm".....	181
7.4.54	Enable Group Object "In operation"	182
7.4.55	Enable Group Object "Trigger reference movement"	182
7.4.56	Enable Group Object "Rain alarm"	182
7.4.57	Enable Group Object "Safety priority x".....	183
7.4.58	Enable Group Object "Block automatic sun protection"	183
7.4.59	Enable Group Object "Status Operability"	184
7.4.60	Enable Group Object "Status Result"	184
7.4.61	Enable group object "Status Load shedding"	185

7.4.62	Enable Group Object "Status Automatic sun protection".....	185
7.4.63	Enable Group Object "Request status values".....	186
7.4.64	Enable Group Object "Wind alarm x".....	186
7.4.65	Enable Group Objects "Move to position Height/Slat".....	186
7.4.66	Enable Group Objects "Status Upper/Lower end position".....	187
7.4.67	Enable Group Objects "Status Result" and "Status Input value between thresholds".....	187
7.4.68	Enable Group Objects "Status Height/Slat".....	188
7.4.69	Enable Group Objects "Status byte" [Shutter Actuator].....	188
7.4.70	Enable Group Objects "Status byte" [Switch Actuator].....	189
7.4.71	Enable Time Group Objects for setting of device time.....	189
7.4.72	Slat position after reaching lower end position (100 % = deactivated).....	190
7.4.73	Determine slat adjustment time.....	190
7.4.74	Load shedding stage.....	191
7.4.75	Overwrite load shedding stage at download.....	191
7.4.76	Change load shedding stage via i-bus® Tool.....	192
7.4.77	Change load shedding stage via Group Object.....	192
7.4.78	Enable Logic/Threshold x-y.....	193
7.4.79	Enable manual operation.....	193
7.4.80	Maximum number of sent telegrams.....	193
7.4.81	Min. duration of the overshoot.....	194
7.4.82	Min. duration of the undershoot.....	194
7.4.83	Minimum run time for drive.....	194
7.4.84	Minimum dwell time between the thresholds.....	195
7.4.85	Upper limit (0 % = top; 100 % = bottom).....	195
7.4.86	Upper limit valid for direct commands.....	195
7.4.87	Upper limit valid for Automatic sun protection commands.....	196
7.4.88	Upper threshold.....	196
7.4.89	Parameter setting.....	196
7.4.90	Move to position.....	197
7.4.91	Position height (0 % = top; 100 % = bottom).....	197
7.4.92	Position slat (0 % = open; 100 % = closed).....	197
7.4.93	Position after reference movement.....	198
7.4.94	Order of priority for weather alarms.....	198
7.4.95	Order of priority of weather alarm, block and forced operation.....	198
7.4.96	Feedback of contact position via Group Object "Status Switch".....	199
7.4.97	Switch output reacts to central Switch Group Object.....	199
7.4.98	Switching reaction on active load shedding stage.....	200
7.4.99	Switching reaction on bus voltage failure.....	200
7.4.100	Switching reaction on revoke of load shedding stage.....	201
7.4.101	Switching reaction on cancellation of block, forced operation and safety priority.....	201
7.4.102	Switching reaction on safety priority x.....	202
7.4.103	Switching reaction on block.....	203
7.4.104	Switching reaction on forced operation.....	204
7.4.105	Overwrite thresholds on download.....	204
7.4.106	Change thresholds via i-bus® Tool.....	205
7.4.107	Change thresholds via Group Objects.....	205
7.4.108	Sending and switching delay after bus voltage recovery.....	206
7.4.109	Sending cycle.....	206
7.4.110	Read safety Group Objects after bus voltage recovery and download.....	207
7.4.111	Deactivate Automatic sun protection on cancellation of weather alarms, block and forced operation.....	207
7.4.112	Read Automatic sun protection Group Objects after bus voltage recovery and download.....	208
7.4.113	Limit step commands to number of slat adjustments.....	208
7.4.114	Tensioning/Slot positioning.....	209
7.4.115	Overwrite Scenes on download.....	209
7.4.116	Scene number.....	210
7.4.117	Scene assignment.....	210
7.4.118	Enable Scene assignment x [Shutter Actuator].....	211
7.4.119	Enable Scene assignment x [Switch Actuator].....	211

7.4.120	GATE blocks if Group Object "Connection A" equals	212
7.4.121	Dead time Blind/Shutter movement from lower end position (100 %)	212
7.4.122	Dead time Blind/Shutter adjustment on change of direction	212
7.4.123	Dead time slat movement (from 100 % closed).....	213
7.4.124	Dead time slat adjustment on change of direction.....	214
7.4.125	Set dead times	214
7.4.126	Block staircase lighting after bus voltage recovery	215
7.4.127	Switching reaction of staircase lighting on telegram value 0/1.....	216
7.4.128	Block staircase lighting via Group Object	216
7.4.129	Staircase lighting time	217
7.4.130	Overwrite staircase lighting time on download.....	217
7.4.131	Restart staircase lighting time after permanent on	218
7.4.132	Staircase lighting time can be started again.....	218
7.4.133	Change staircase lighting time via i-bus® Tool	219
7.4.134	Change staircase lighting time via Group Object.....	219
7.4.135	Staircase lighting time extendable (pumping)	220
7.4.136	Reversing time	220
7.4.137	Lower limit (0 % = top; 100 % = bottom)	221
7.4.138	Lower limit valid for direct commands	221
7.4.139	Lower limit valid for Automatic sun protection commands.....	221
7.4.140	Lower threshold.....	222
7.4.141	Reaction on result "0" [Shutter Actuator].....	222
7.4.142	Reaction on result "0" [Switch Actuator]	223
7.4.143	Reaction on result "1" [Shutter Actuator]	224
7.4.144	Reaction on result "1" [Switch Actuator].....	225
7.4.145	Reaction on sun = 0 (no sun).....	225
7.4.146	Reaction on sun = 1 (sun)	226
7.4.147	Reaction on Scene recall	228
7.4.148	Reaction of output	228
7.4.149	Reaction after flashing.....	229
7.4.150	Reaction after bus voltage recovery [Shutter Actuator]	229
7.4.151	Reaction after bus voltage recovery [Switch Actuator].....	230
7.4.152	Reaction after ETS download [Shutter Actuator]	230
7.4.153	Reaction after ETS download [Switch Actuator].....	231
7.4.154	Delay.....	233
7.4.155	Delay for sun = 0	234
7.4.156	Delay for sun = 1.....	234
7.4.157	Delay time for drive.....	235
7.4.158	Total turning of slats after down movement	235
7.4.159	Warning before switching off the staircase lighting	236
7.4.160	Warning time	236
7.4.161	Send value of Group Object "Status Operability"	237
7.4.162	Send value of Group Object "Status Result"	237
7.4.163	Send value of Group Object "Status Load shedding"	238
7.4.164	Value of Group Object "Status Switch"	239
7.4.165	Send value of Group Object "Status Switch"	239
7.4.166	Send value of Group Object "Status Automatic sun protection"	240
7.4.167	Value of Group Object "Connection A" after bus voltage recovery	240
7.4.168	Value of Group Object "Connection B" after bus voltage recovery	241
7.4.169	Send value of Group Objects "Status Upper/Lower end position".....	241
7.4.170	Send value of Group Objects "Status Height/Slat"	242
7.4.171	Send value of Group Objects "Status byte" [Shutter Actuator]	243
7.4.172	Send value of Group Objects "Status byte" [Switch Actuator]	244
7.4.173	Value after sending and switching delay has expired.....	244
7.4.174	Send values of Group Objects "Status Result" and "Status Input value between thresholds"	245
7.4.175	Time for off.....	245
7.4.176	Time for automatic reactivation of Automatic sun protection	246
7.4.177	Time for on.....	246

7.4.178	Enable central Group Objects "Shutter"	247
7.4.179	Enable central Group Object "Receive load shedding stage"	247
7.4.180	Enable central Group Object "Switch"	248
7.4.181	Enable central Group Object "Scene 1 ... 64"	248
7.4.182	i-bus® Tool access	248
7.4.183	State after end of manual operation	249
7.4.184	Forced operation (1 bit / 2 bit) [Shutter Actuator]	249
7.4.185	Forced operation (1 bit / 2 bit) [Switch Actuator]	250
7.4.186	Cyclical monitoring	250
8	Group Objects	251
8.1	Overview of Group Objects	251
8.2	Group Objects "Central"	252
8.3	Group Objects "Device"	255
8.4	Group Objects "Safety"	256
8.5	Group Objects Logic/Threshold X	257
8.6	Group Objects Channel X + Y: Shutter	264
8.7	Group Objects "Channel X": Switch	271
8.8	Group Objects "Channel X": Load shedding	275
9	Operation	277
9.1	Manual operation	277
9.1.1	Central switch-off via membrane keypad	277
9.1.2	Activating manual operation	278
9.1.3	Blocking manual operation	278
9.1.4	Ending manual operation	278
10	Maintenance and cleaning	279
10.1	Maintenance	279
10.2	Cleaning	279
11	Removal and disposal	280
11.1	Removal	280
11.2	Environment	280
12	Planning and application	281
12.1	Priorities	281
12.1.1	Priorities for Shutter Actuator	281
12.1.2	Priorities for Switch Actuator	281
12.2	Basic knowledge	282
12.2.1	AC-1, AC-3, AC-5, AX and C load	282
12.2.2	Drive settings	283
12.2.3	Blind/Slat settings	287
12.2.4	Coding, Group Object "Receive load shedding stage"	290
12.2.5	Coding, Group Object "Set load shedding stage"	290
12.2.6	Ballast calculation	291
12.2.7	Refreshed KNX state	291
12.2.8	Sending and switching delay	291
12.2.9	Telegram rate limit	292
12.2.10	Value Read	292
12.2.11	Central Group Objects	292
12.2.12	Cyclical monitoring	293
13	Appendix	294
13.1	Scope of delivery	294
13.2	Table of values, Group Object "Status byte all active priorities" (Switch Actuator)	295
13.3	Table of values, Group Object "Status byte all active priorities" (Shutter Actuator)	297
13.4	Table of values, Group Object "Scene 1 ... 64"	299

1 About this document

1.1 Using the product manual

This manual provides detailed technical information on the function, installation and programming of the ABB i-bus® KNX device.

1.2 Legal disclaimer

ABB AG reserves the right to make changes to the product or modify the contents of this document without prior notice.

The agreed properties are definitive for any orders placed. ABB AG does not accept any responsibility whatsoever for potential errors or possible lack of information in this document.

ABB AG reserves all rights in this document and in the subject matter and illustrations contained therein. Reproduction, transfer to third parties or processing of the content – including sections thereof – is not permitted without the prior written consent of ABB AG.

Copyright © 2022 ABB AG
All rights reserved

1.3 Explanation of symbols

1.	Instructions in specified sequence and result
2.	
⇒	
▶	Individual actions
a)	Priorities
1)	Processes run by the device in a specific sequence
•	List level 1
–	List level 2

Tab. 1: Explanation of symbols

Notes and warnings are represented as follows in this manual:



DANGER

This symbol is a warning about electrical voltage and indicates high-risk hazards that will definitely result in death or serious injury unless avoided.



DANGER

Indicates high-risk hazards that will definitely result in death or serious injury unless avoided.



WARNING

Indicates medium-risk hazards that could result in death or serious injury unless avoided.



CAUTION

Indicates low-risk hazards that could result in slight or moderate injury unless avoided.



CAUTION

Indicates a risk of malfunctions or damage to property and equipment, but with no risk to life and limb.

Example

For use in application, installation and programming examples

i Note

For use in tips on use and operation

2 Safety

2.1 General safety instructions

- ▶ Protect the device from moisture, dirt and damage during transport, storage and operation.
- ▶ Operate the device only in a closed housing (distribution board).
- ▶ Operate the device only within the specified technical data.
- ▶ Mounting, installation, commissioning and maintenance must be carried out only by qualified electricians.
- ▶ Disconnect device from the supply of electrical power before mounting.

2.2 Qualification of the specialist personnel

Programming the device requires detailed specialist knowledge – particularly about the ETS commissioning software – through KNX training courses.

2.3 Proper use

The Switch Actuator outputs of Switch/Shutter Actuators SAH/S are intended to be used to switch electrical loads in single- or multi-phase electrical networks in a KNX environment.

The Shutter Actuator output pairs of Switch/Shutter Actuators SAH/S are intended to be used to activate AC drives for Blind/Shutter in a KNX environment.



CAUTION

The outputs on the device are not interlocked mechanically. Connecting shutter/blind motors to Switch Actuator outputs will result in damage to the shutter/blind motor.

- ▶ Connect shutter/blind motors only to Shutter Actuator output pairs.

3 Product overview

3.1 Device description

The devices are modular installation devices (MDRC) in proM design. They are designed for installation in electrical distribution boards and small housings with a 35 mm mounting rail (to EN 60715).

The devices are KNX-certified and can be used as products in a KNX system → EU declaration of conformity.

The devices are powered via the bus (ABB i-bus® KNX) and require no additional auxiliary voltage. The connection to the bus is made via a bus connection terminal on the front of the housing. The loads are connected to the outputs using screw terminals → terminal designation on the housing.

The software application Engineering Tool Software (ETS) is used for physical address assignment and parameterization.

3.1.1 Membrane keypad

The devices can be operated manually using the membrane keypad.

Complete overview of operating and display elements → corresponding sub-chapter of the individual product variant.

Note

The safety functions (weather alarms as well as the functions *Safety priority*, *Forced operation* and *Block*) take priority over *Manual operation* mode. An output cannot be operated using the membrane keypad if it is blocked by a safety function. If the safety function is canceled in *Manual operation* operating mode, the output reacts corresponding to its parameterization.

3.2 Product name description

Abbreviation	Description
SAH	Switch/Shutter Actuator
/S	MDRC
x.	8 = 8-fold
	16 = 16-fold
	24 = 24-fold
x.	6 = 6 A
	10 = 10 A
	16 = 16 A
x.	7 = Combined function (Switch/Shutter)
x	x = Version number (x = 1, 2, etc.)

Tab. 2: Product name description

3.3 Ordering details

Description	MW	Type	Order no.	Packaging unit [pcs.]	Weight (incl. packaging) [kg]
Switch/Shutter	4	SAH/S 8.6.7.1	2CDG110244R0011	1	0.35
Switch/Shutter	8	SAH/S 16.6.7.1	2CDG110245R0011	1	0.60
Switch/Shutter	12	SAH/S 24.6.7.1	2CDG110246R0011	1	0.83
Switch/Shutter	4	SAH/S 8.10.7.1	2CDG110247R0011	1	0.35
Switch/Shutter	8	SAH/S 16.10.7.1	2CDG110248R0011	1	0.60
Switch/Shutter	12	SAH/S 24.10.7.1	2CDG110249R0011	1	0.83
Switch/Shutter	4	SAH/S 8.16.7.1	2CDG110250R0011	1	0.35
Switch/Shutter	8	SAH/S 16.16.7.1	2CDG110251R0011	1	0.60
Switch/Shutter	12	SAH/S 24.16.7.1	2CDG110252R0011	1	0.83

Tab. 3: Ordering details

3.4 Connections

The devices possess the following connections:

- Depending on the device type, 8, 16 or 24 relay outputs for switching electrical loads (individually) or 230 V AC shutter drives (in pairs)
- 1 bus connection



CAUTION

The outputs on the device are not interlocked mechanically. Connecting shutter/blind motors to Switch Actuator outputs will result in damage to the shutter/blind motor.

- ▶ Connect shutter/blind motors only to Shutter Actuator output pairs.

3.4.1 Inputs

This section is not relevant for these devices.

3.4.2 Outputs

Note

A device with 24 channels (A ... X) is described below.

The outputs can be used individually to switch electrical loads or in pairs to activate 230 V AC blind and shutter drives. Switch, shutter and blind outputs can be mixed.

Function	A	B	C	D	E	F	G	H	I	J	K	L	M	N	O	P	Q	R	S	T	U	V	W	X
Switch	x	x	x	x	x	x	x	x	x	x	x	x	x	x	x	x	x	x	x	x	x	x	x	x
Shutter	x		x		x		x		x		x		x		x		x		x		x		x	

Tab. 4: Functions of the outputs

3.5 Switch/Shutter Actuator SAH/S 8.6.7.1, 8-fold, 6 A, MDRC



Fig. 1: Device illustration SAH/S 8.6.7.1

9PAA00000003630-Rev_A

3.5.1 Dimension drawing

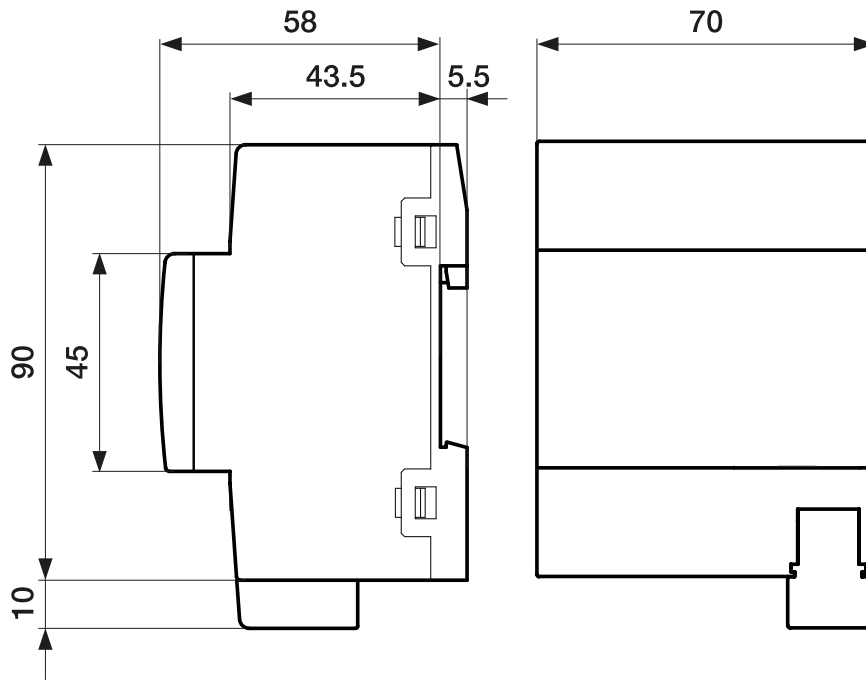

Fig. 2: Dimension drawing

2CDC072033F0015

3.5.2 Connection diagram

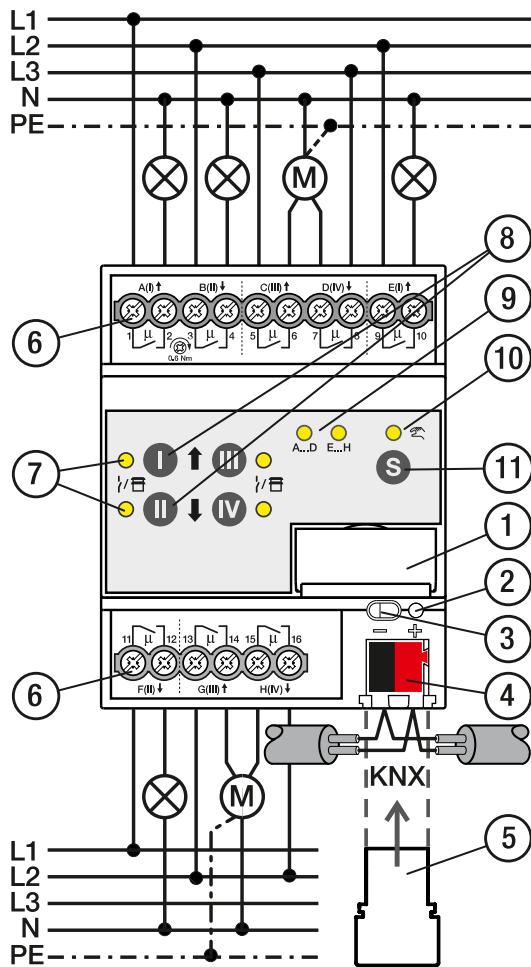

Fig. 3: Connection diagram SAH/S 8.x.7.1

Legend

- 1 label carrier
- 2 *Programming LED*
- 3 *Programming button*
- 4 Bus connection terminal
- 5 Cover cap
- 6 Load circuit, two screw terminals each
- 7 *LED Output*
- 8 *Output button*
- 9 *Group LED*
- 10 *LED Manual operation*
- 11 *S button*

2CDC072006F0019

3.5.3 Operating and display elements

Note

In *Shutter* mode, the function of the *Output* button/LEDs is identical for every shutter output pair. Only the buttons/LEDs I and II are described below.



Note

In the KNX operation operating mode, it cannot be identified from the *Output LED* whether a switching output is blocked.

Operating control/LED	Description/function	Display
	Assignment of the physical address	LED On: Device in programming mode
<i>Programming button/LED</i>		





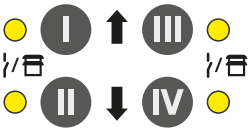





Tab. 5: Operating and display elements

3.5.3.1 Manual mode

Operating control/LED	Description/function	Display
	Short button push < 2 s: Selection of relay group Button push 2 ... 5 s: Changeover to <i>KNX operation</i> Long button push > 5 s: Selection of all relays	LED On: <i>Manual operation</i> active LED Off: <i>KNX operation</i> active
<i>S button / Manual operation LED</i>		
		LED On: Group selected LED Off: Group not selected
<i>Group LED</i>		
	Switch Actuator application: Switching of the outputs (toggle function) Button I: First output of group (A/E) Button II: Second output of group (B/F) Button III: Third output of group (C/G) Button IV: Fourth output of group (D/H)	Switch Actuator application: LED On: Relay contact closed LED Off: Relay contact open LED flashing (1 Hz): Output blocked; manual operation not possible.
<i>Output button/LED</i>		
	Shutter Actuator application: Control of the shutter output pairs Button I: <ul style="list-style-type: none"> Long button push > 1 s: Shutter Up Short button push < 1 s: Shutter Stop/ slat adjustment Button II: <ul style="list-style-type: none"> Long button push > 1 s: Shutter Down Short button push < 1 s: Shutter Stop/ slat adjustment 	Shutter Actuator application: LED I On and LED II Off: Upper end position LED I Off and LED II On: Lower end position LED I Off and LED II Off: Intermediate position LED I flashing (1 Hz) and LED II Off: Up movement LED I Off and LED II flashing (1 Hz): Down movement LED I flashing (1 Hz) and LED II flashing (1 Hz): Shutter output pair blocked LED I flashing (5 Hz) and LED II flashing (5 Hz): Shutter output pair active (after the group is changed or after change to <i>Manual operation</i> operating mode)

Tab. 6: Operating and display elements

3.5.3.2 KNX operation

Operating control/LED	Description/function	Display
  <i>S button / Manual operation LED</i>	Short button push < 2 s: Selection of relay group Button push 2 ... 5 s: Change to <i>manual operation</i> Long button push > 5 s: Selection of all relays	LED On: <i>Manual operation</i> active LED Off: <i>KNX operation</i> active LED flashing (1 Hz) while button pressed: <i>Manual operation</i> not enabled or blocked
  <i>Group LED</i>		LED On: Group selected LED Off: Group not selected
      <i>Output button/LED</i>	Button without function	<p>Switch Actuator application: LED On: Relay contact closed LED Off: Relay contact open</p> <p>Shutter Actuator application: LED I On and LED II Off: Upper end position LED I Off and LED II On: Lower end position LED I Off and LED II Off: Intermediate position LED I flashing (1 Hz) and LED II Off: Up movement LED I Off and LED II flashing (1 Hz): Down movement LED I flashing (1 Hz) and LED II flashing (1 Hz): Shutter output pair blocked LED I flashing (5 Hz) and LED II flashing (5 Hz): Shutter output pair active (after the group is changed or after change to <i>KNX operation</i>)</p>

Tab. 7: Operating and display elements

3.5.4 Technical data

3.5.4.1 General technical data

Device	Dimensions	90 × 70 × 63.5 mm (H × W × D)
	Mounting width in space units	4 modules, 17.5 mm each
	Weight	0.27 kg
	Mounting position	Any
	Mounting variant	35 mm mounting rail
	Design	proM
	Degree of protection	IP 20
	Protection class	II
	Overvoltage category	III
	Pollution degree	2
Materials	Housing	Polycarbonate, Makrolon FR6002, halogen free
Material note	Fire classification	Flammability V-0
Electronics	Rated voltage, bus	30 V DC
	Voltage range, bus	21 ... 31 V DC
	Current consumption, bus	< 12 mA
	Maximum current, device	8 × 6 A
	Power loss, device	≤ 2.5 W
	Power loss, bus	≤ 0.25 W
	KNX safety extra low voltage	SELV
Connections	Connection type, KNX bus	Plug-in terminal
	Cable diameter, KNX bus	0.6 ... 0.8 mm, solid
	Connection type, load circuit	Screw terminal with universal head (PZ 1)
	Pitch	6.35 mm
	Tightening torque, screw terminals	0.5 ... 0.6 Nm
	Conductor cross-section, flexible	1 × (0.2 ... 4 mm ²) / 2 × (0.2 ... 2.5 mm ²)
	Conductor cross section, rigid	1 × (0.2 ... 6 mm ²) / 2 × (0.2 ... 4 mm ²)
	Conductor cross section with wire end ferrule without plastic sleeve	1 × (0.25 ... 2.5 mm ²)
	Conductor cross section with wire end ferrule with plastic sleeve	1 × (0.25 ... 4 mm ²)
	Conductor cross section with TWIN wire end ferrule	1 × (0.5 ... 2.5 mm ²)
Length, wire end ferrule contact pin	≥ 10 mm	
Certificates and declarations	Declaration of conformity CE	→ 2CDK505204D2701
Ambient conditions	Operation	-5 ... +45 °C
	Transport	-25 ... +70 °C
	Storage	-25 ... +55 °C
	Humidity	≤ 95 %
	Condensation allowed	No
	Atmospheric pressure	≥ 80 kPa (corresponds to air pressure at 2,000 m above sea level)

Tab. 8: General technical data

3.5.4.2 Outputs – relays 6 A







Rated values	Number of outputs	8 switch/4 shutter
	Rated voltage U_n	230 V AC
	Rated current I_n (per output)	6 A
	Rated frequency	50/60 Hz
	Relay type	Bi-stable
Switching currents	AC-1 operation ($\cos \varphi = 0.8$)	≤ 6 A
	AC-3 operation ($\cos \varphi = 0.45$)	≤ 6 A
	Switching current at 12 V AC	≥ 0.1 A
	Switching current at 24 V AC	≥ 0.1 A
	Switching current at 24 V DC (resistive load)	≤ 6 A
Service life	Mechanical service life	$\geq 10^6$ switching operations
	AC-1 operation ($\cos \varphi = 0.8$)	$\geq 10^5$ switching operations
	AC-3 operation ($\cos \varphi = 0.45$)	$\geq 6 \times 10^3$ switching operations
Switching operations	Switching operations per minute when one relay switches	≤ 120
	Switching operations per minute when all relays switch	≤ 15
Starting current	Starting current I_{peak} (150 μ s)	≤ 200 A
	Starting current I_{peak} (250 μ s)	≤ 160 A
	Starting current I_{peak} (600 μ s)	≤ 100 A

Tab. 9: Outputs – relays 6 A

Note

The starting current I_{peak} is the typical ballast load current that results during switching. Using the starting current I_{peak} , it is possible to calculate the maximum number of switchable ballasts at the Switch Actuator output → [Ballast calculation, Page 291](#).

3.5.4.2.1 Load table

Load type	Symbol	Max. load
Incandescent bulbs		1200 W
Fluorescent lamps uncompensated		800 W
Low-voltage halogen lamps inductive transformer		800 W
Low-voltage halogen lamps electronic transformer		1000 W
Low-voltage halogen lamps 230 V		1000 W
Dulux lamps uncompensated		800 W
Dulux lamps parallel compensated		800 W
LED lamps		250 W
Rated motor power		1380 W

Tab. 10: Load table

3.5.4.3 Device type

Device type	Switch/Shutter Actuator	SAH/S 8.6.7.1
	Application	Switch/Shutter 8-fold 6 A / = current version number of the application
	Maximum number of Group Objects	282
	Maximum number of group addresses	1000
	Maximum number of assignments	1000

Tab. 10: Device type

i Note

Observe software information on the website → www.abb.com/knx.

i Note

The device may be protected with a BCU key in ETS. If a BCU key was assigned, the device cannot be read or programmed without it.

3.6 Switch/Shutter Actuator SAH/S 16.6.7.1, 16-fold, 6 A, MDRC



Fig. 4: Device illustration SAH/S 16.6.7.1

9PAA00000003617-Rev_A

3.6.1 Dimension drawing

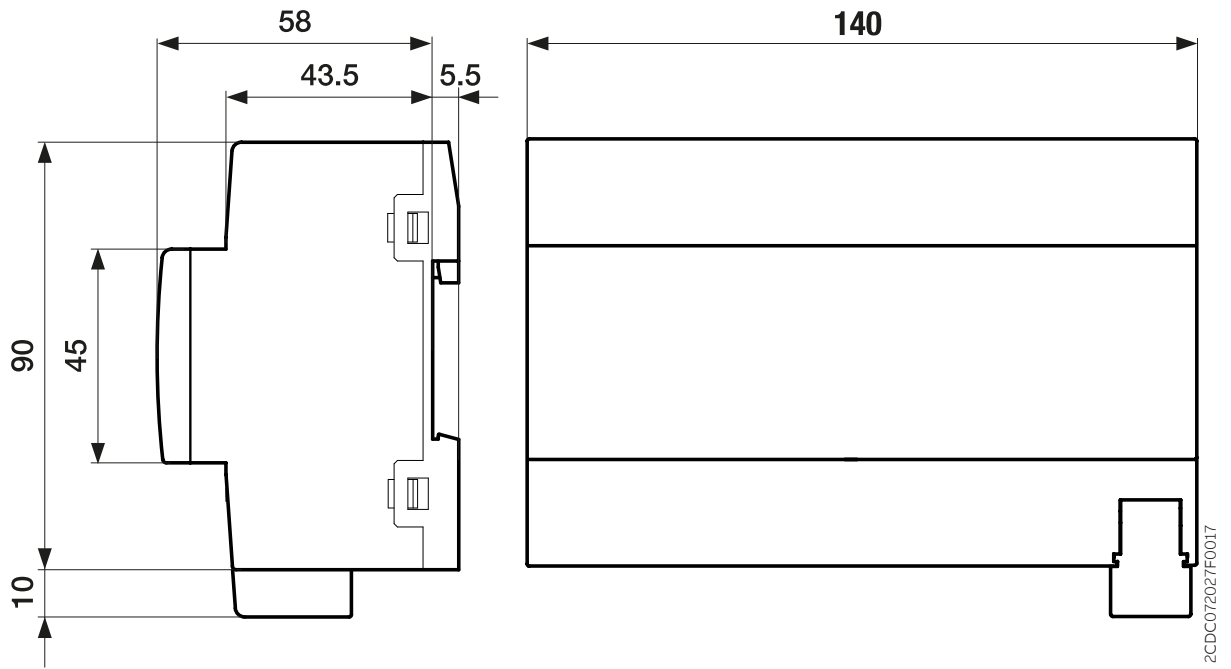

Fig. 5: Dimension drawing

3.6.2 Connection diagram

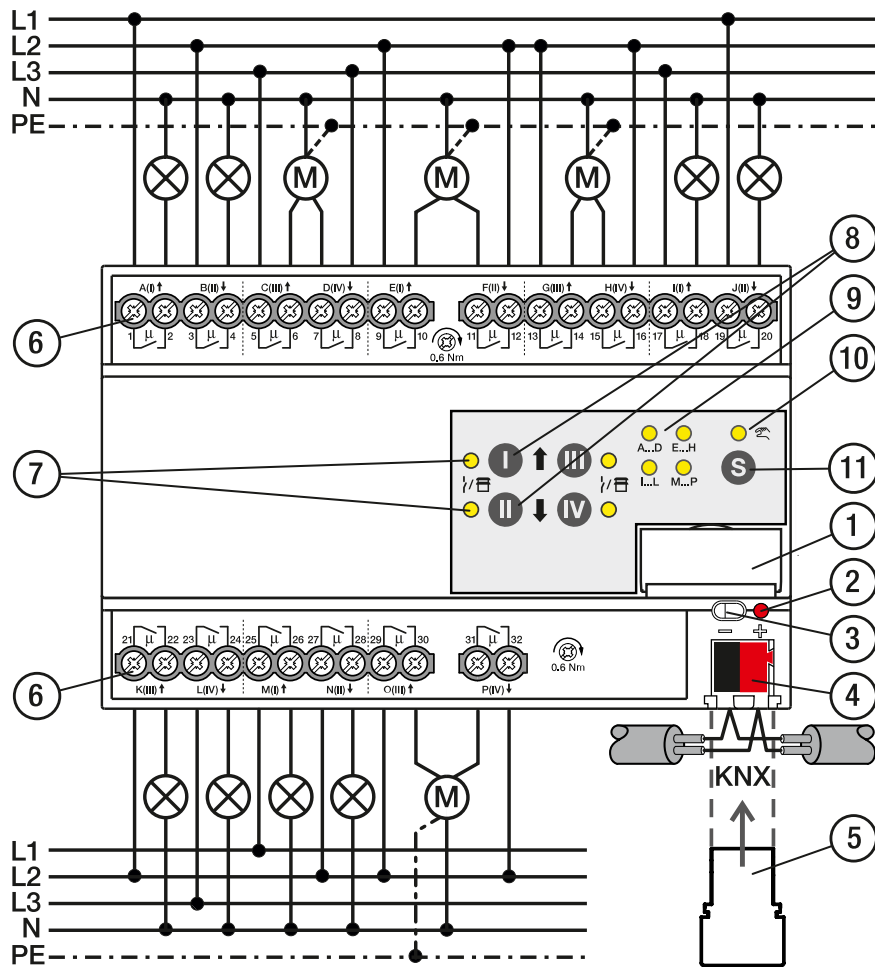

Fig. 6: Connection diagram SAH/S 16.x.7.1

Legend

- | | |
|--|-------------------------|
| 1 label carrier | 7 LED Output |
| 2 Programming LED | 8 Output button |
| 3 Programming button | 9 Group LED |
| 4 Bus connection terminal | 10 LED Manual operation |
| 5 Cover cap | 11 S button |
| 6 Load circuit, two screw terminals each | |

2CDC072007F0019

3.6.3 Operating and display elements

Note
In *Shutter* mode, the function of the *Output* button/LEDs is identical for every shutter output pair. Only the buttons/LEDs I and II are described below.



Note
In the KNX operation operating mode, it cannot be identified from the *Output LED* whether a switching output is blocked.

Operating control/LED	Description/function	Display
	Assignment of the physical address	LED On: Device in programming mode

Programming button/LED



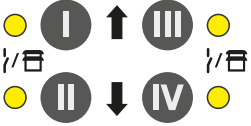

Tab. 11: Operating and display elements

3.6.3.1 Manual mode

Operating control/LED	Description/function	Display
	Short button push < 2 s: Selection of relay group	LED On: <i>Manual operation</i> active LED Off: <i>KNX operation</i> active
	Button push 2 ... 5 s: Changeover to <i>KNX operation</i> Long button push > 5 s: Selection of all relays	
		LED On: Group selected LED Off: Group not selected
	Switch Actuator application: Switching of the outputs (toggle function) Button I: First output of group (A/E/I/M) Button II: Second output of group (B/F/J/N) Button III: Third output of group (C/G/K/O) Button IV: Fourth output of group (D/H/L/P) Shutter Actuator application: Control of the shutter output pairs Button I: <ul style="list-style-type: none"> Long button push > 1 s: Shutter Up Short button push < 1 s: Shutter Stop/slat adjustment Button II: <ul style="list-style-type: none"> Long button push > 1 s: Shutter Down Short button push < 1 s: Shutter Stop/slat adjustment 	Switch Actuator application: LED On: Relay contact closed LED Off: Relay contact open LED flashing (1 Hz): Output blocked; manual operation not possible. Shutter Actuator application: LED I On and LED II Off: Upper end position LED I Off and LED II On: Lower end position LED I Off and LED II Off: Intermediate position LED I flashing (1 Hz) and LED II Off: Up movement LED I Off and LED II flashing (1 Hz): Down movement LED I flashing (1 Hz) and LED II flashing (1 Hz): Shutter output pair blocked LED I flashing (5 Hz) and LED II flashing (5 Hz): Shutter output pair active (after the group is changed or after change to <i>Manual operation</i> operating mode)

Tab. 12: Operating and display elements

3.6.3.2 KNX operation

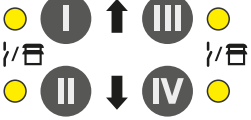
Operating control/LED	Description/function	Display
  <i>S button / Manual operation LED</i>	Short button push < 2 s: Selection of relay group Button push 2 ... 5 s: Change to <i>manual operation</i> Long button push > 5 s: Selection of all relays	LED On: <i>Manual operation</i> active LED Off: <i>KNX operation</i> active LED flashing (1 Hz) while button pressed: <i>Manual operation</i> not enabled or blocked
  <i>Group LED</i>		LED On: Group selected LED Off: Group not selected
 <i>Output button/LED</i>	Button without function	<p>Switch Actuator application: LED On: Relay contact closed LED Off: Relay contact open</p> <p>Shutter Actuator application: LED I On and LED II Off: Upper end position LED I Off and LED II On: Lower end position LED I Off and LED II Off: Intermediate position LED I flashing (1 Hz) and LED II Off: Up movement LED I Off and LED II flashing (1 Hz): Down movement LED I flashing (1 Hz) and LED II flashing (1 Hz): Shutter output pair blocked LED I flashing (5 Hz) and LED II flashing (5 Hz): Shutter output pair active (after the group is changed or after change to <i>KNX operation</i>)</p>

Tab. 13: Operating and display elements

3.6.4 Technical data

3.6.4.1 General technical data

Device	Dimensions	90 × 140 × 63.5 mm (H x W x D)
	Mounting width in space units	8 modules, 17.5 mm each
	Weight	0.5 kg
	Mounting position	Any
	Mounting variant	35 mm mounting rail
	Design	proM
	Degree of protection	IP 20
	Protection class	II
	Overvoltage category	III
Materials	Pollution degree	2
	Housing	Polycarbonate, Makrolon FR6002, halogen free
Material note	Fire classification	Flammability V-0
Electronics	Rated voltage, bus	30 V DC
	Voltage range, bus	21 ... 31 V DC
	Current consumption, bus	< 12 mA
	Maximum current, device	16 × 6 A
	Power loss, device	≤ 5 W
	Power loss, bus	≤ 0.25 W
	KNX safety extra low voltage	SELV
Connections	Connection type, KNX bus	Plug-in terminal
	Cable diameter, KNX bus	0.6 ... 0.8 mm, solid
	Connection type, load circuit	Screw terminal with universal head (PZ 1)
	Pitch	6.35 mm
	Tightening torque, screw terminals	0.5 ... 0.6 Nm
	Conductor cross-section, flexible	1 × (0.2 ... 4 mm ²) / 2 × (0.2 ... 2.5 mm ²)
	Conductor cross section, rigid	1 × (0.2 ... 6 mm ²) / 2 × (0.2 ... 4 mm ²)
	Conductor cross section with wire end ferrule without plastic sleeve	1 × (0.25 ... 2.5 mm ²)
	Conductor cross section with wire end ferrule with plastic sleeve	1 × (0.25 ... 4 mm ²)
Certificates and declarations	Conductor cross section with TWIN wire end ferrule	1 × (0.5 ... 2.5 mm ²)
	Length, wire end ferrule contact pin	≥ 10 mm
Ambient conditions	Declaration of conformity CE	→ 2CDC505207D2701
Ambient conditions	Operation	-5 ... +45 °C
	Transport	-25 ... +70 °C
	Storage	-25 ... +55 °C
	Humidity	≤ 95 %
	Condensation allowed	No
	Atmospheric pressure	≥ 80 kPa (corresponds to air pressure at 2,000 m above sea level)

Tab. 14: General technical data

3.6.4.2 Outputs – relays 6 A







Rated values	Number of outputs	16 switch/8 shutter
	Rated voltage U_n	230 V AC
	Rated current I_n (per output)	6 A
	Rated frequency	50/60 Hz
	Relay type	Bi-stable
Switching currents	AC-1 operation ($\cos \varphi = 0.8$)	≤ 6 A
	AC-3 operation ($\cos \varphi = 0.45$)	≤ 6 A
	Switching current at 12 V AC	≥ 0.1 A
	Switching current at 24 V AC	≥ 0.1 A
	Switching current at 24 V DC (resistive load)	≤ 6 A
Service life	Mechanical service life	$\geq 10^6$ switching operations
	AC-1 operation ($\cos \varphi = 0.8$)	$\geq 10^5$ switching operations
	AC-3 operation ($\cos \varphi = 0.45$)	$\geq 6 \times 10^3$ switching operations
Switching operations	Switching operations per minute when one relay switches	≤ 120
	Switching operations per minute when all relays switch	≤ 7
Starting current	Starting current I_{peak} (150 μ s)	≤ 200 A
	Starting current I_{peak} (250 μ s)	≤ 160 A
	Starting current I_{peak} (600 μ s)	≤ 100 A

Tab. 15: Outputs – relays 6 A

Note

The starting current I_{peak} is the typical ballast load current that results during switching. Using the starting current I_{peak} , it is possible to calculate the maximum number of switchable ballasts at the Switch Actuator output → [Ballast calculation, Page 291](#).

3.6.4.2.1 Load table

Load type	Symbol	Max. load
Incandescent bulbs		1200 W
Fluorescent lamps uncompensated		800 W
Low-voltage halogen lamps inductive transformer		800 W
Low-voltage halogen lamps electronic transformer		1000 W
Low-voltage halogen lamps 230 V		1000 W
Mercury-vapor lamps uncompensated		1000 W
Mercury-vapor lamps parallel compensated		800 W
LED lamps		250 W
Rated motor power		1380 W

Tab. 17: Load table

3.6.4.3 Device type

Device type	Switch/Shutter Actuator	SAH/S 16.6.7.1
	Application	Switch/Shutter 16-fold 6 A / = current version number of the application
	Maximum number of Group Objects	446
	Maximum number of group addresses	1000
	Maximum number of assignments	1000

Tab. 16: Device type

i Note

Observe software information on the website → www.abb.com/knx.

i Note

The device may be protected with a BCU key in ETS. If a BCU key was assigned, the device cannot be read or programmed without it.

3.7 Switch/Shutter Actuator SAH/S 24.6.7.1, 24-fold, 6 A, MDRC



Fig. 7: Device illustration SAH/S 24.6.7.1

9PAA00000003657-Rev_A

3.7.1 Dimension drawing

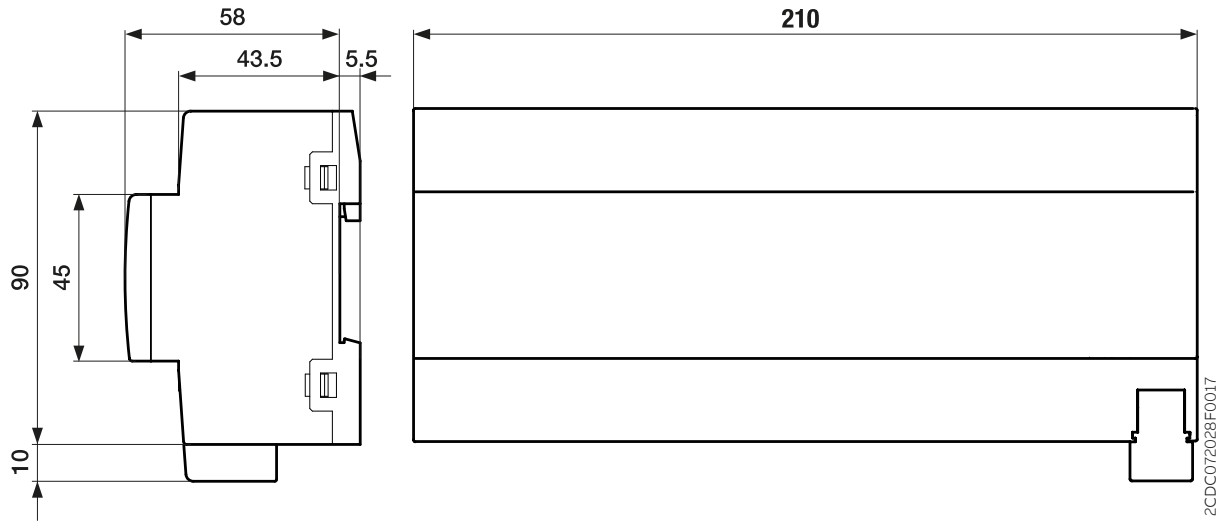

Fig. 8: Dimension drawing

3.7.2 Connection diagram

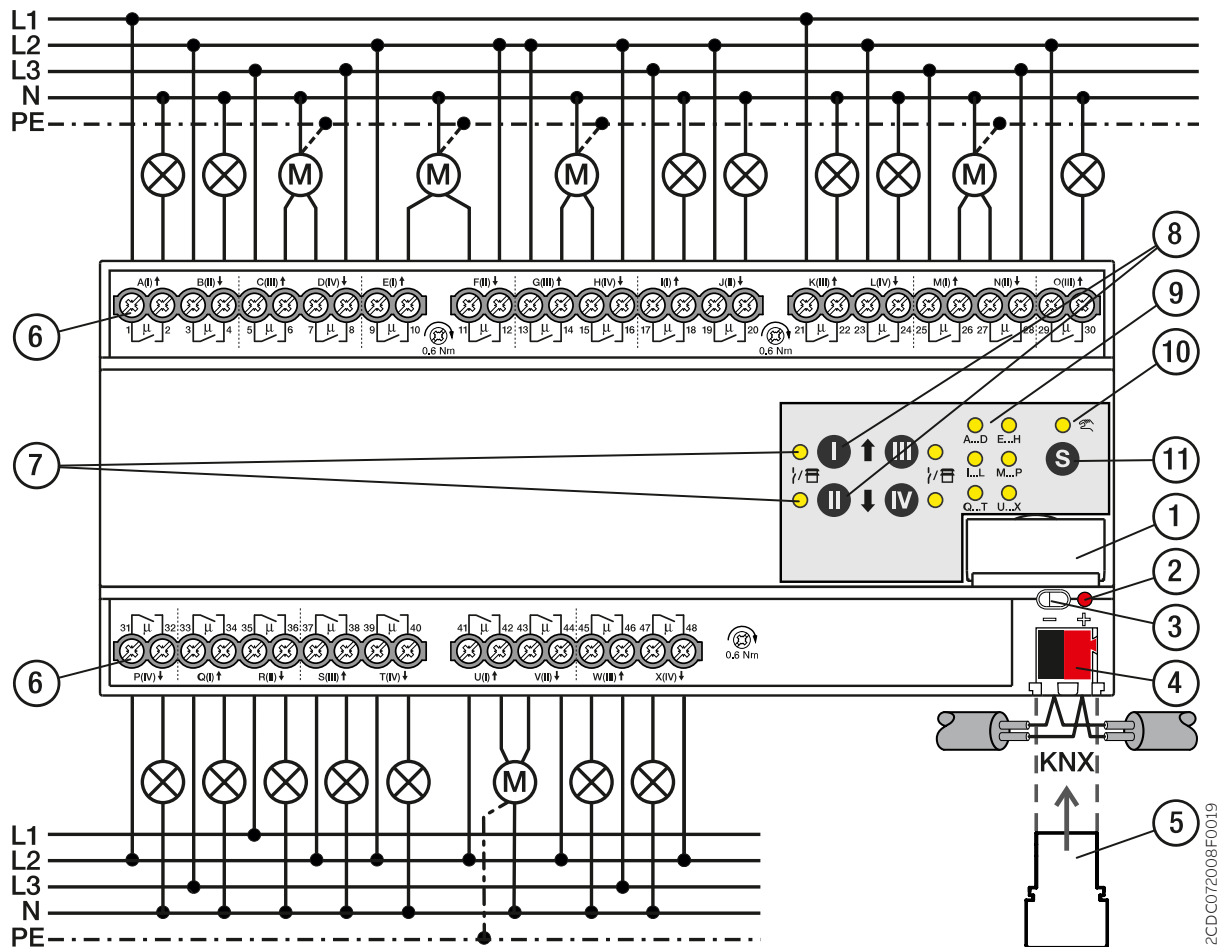

Fig. 9: Connection diagram SAH/S 24.x.7.1

Legend

- | | |
|--|-------------------------|
| 1 label carrier | 7 LED Output |
| 2 Programming LED | 8 Output button |
| 3 Programming button | 9 Group LED |
| 4 Bus connection terminal | 10 LED Manual operation |
| 5 Cover cap | 11 S button |
| 6 Load circuit, two screw terminals each | |

2CDC072008F0019

3.7.3 Operating and display elements

Note

In *Shutter* mode, the function of the *Output* button/LEDs is identical for every shutter output pair. Only the buttons/LEDs I and II are described below.

Note





In the KNX operation operating mode, it cannot be identified from the *Output LED* whether a switching output is blocked.

Operating control/LED	Description/function	Display
	Assignment of the physical address	LED On: Device in programming mode

Programming button/LED



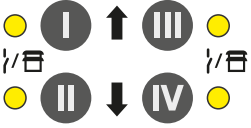

Tab. 17: Operating and display elements

3.7.3.1 Manual mode

Operating control/LED	Description/function	Display
	Short button push < 2 s: Selection of relay group	LED On: <i>Manual operation</i> active LED Off: <i>KNX operation</i> active
	Button push 2 ... 5 s: Changeover to <i>KNX operation</i> Long button push > 5 s: Selection of all relays	
<i>S button / Manual operation LED</i>		
 A...D E...H  I...L M...P  Q...T U...X <i>Group LED</i>		LED On: Group selected LED Off: Group not selected
	Switch Actuator application: Switching of the outputs (toggle function) Button I: First output of group (A/E/I/M/Q/U) Button II: Second output of group (B/F/J/N/R/V) Button III: Third output of group (C/G/K/O/S/W) Button IV: Fourth output of group (D/H/L/P/T/X)	Switch Actuator application: LED On: Relay contact closed LED Off: Relay contact open LED flashing (1 Hz): Output blocked; manual operation not possible.
<i>Output button/LED</i>	Shutter Actuator application: Control of the shutter output pairs Button I: <ul style="list-style-type: none"> Long button push > 1 s: Shutter Up Short button push < 1 s: Shutter Stop/ slat adjustment Button II: <ul style="list-style-type: none"> Long button push > 1 s: Shutter Down Short button push < 1 s: Shutter Stop/ slat adjustment 	Shutter Actuator application: LED I On and LED II Off: Upper end position LED I Off and LED II On: Lower end position LED I Off and LED II Off: Intermediate position LED I flashing (1 Hz) and LED II Off: Up movement LED I Off and LED II flashing (1 Hz): Down movement LED I flashing (1 Hz) and LED II flashing (1 Hz): Shutter output pair blocked LED I flashing (5 Hz) and LED II flashing (5 Hz): Shutter output pair active (after the group is changed or after change to <i>Manual operation</i> operating mode)

Tab. 18: Operating and display elements

3.7.3.2 KNX operation

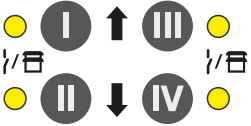
Operating control/LED	Description/function	Display
  <i>S button / Manual operation LED</i>	Short button push < 2 s: Selection of relay group Button push 2 ... 5 s: Change to <i>manual operation</i> Long button push > 5 s: Selection of all relays	LED On: <i>Manual operation</i> active LED Off: <i>KNX operation</i> active LED flashing (1 Hz) while button pressed: <i>Manual operation</i> not enabled or blocked
   <i>Group LED</i>		LED On: Group selected LED Off: Group not selected
 <i>Output button/LED</i>	Button without function	Switch Actuator application: LED On: Relay contact closed LED Off: Relay contact open Shutter Actuator application: LED I On and LED II Off: Upper end position LED I Off and LED II On: Lower end position LED I Off and LED II Off: Intermediate position LED I flashing (1 Hz) and LED II Off: Up movement LED I Off and LED II flashing (1 Hz): Down movement LED I flashing (1 Hz) and LED II flashing (1 Hz): Shutter output pair blocked LED I flashing (5 Hz) and LED II flashing (5 Hz): Shutter output pair active (after the group is changed or after change to <i>KNX operation</i>)

Tab. 19: Operating and display elements

3.7.4 Technical data

3.7.4.1 General technical data

Device	Dimensions	90 × 210 × 63.5 mm (H x W x D)
	Mounting width in space units	12 modules, 17.5 mm each
	Weight	0.72 kg
	Mounting position	Any
	Mounting variant	35 mm mounting rail
	Design	proM
	Degree of protection	IP 20
	Protection class	II
	Overvoltage category	III
Materials	Pollution degree	2
	Housing	Polycarbonate, Makrolon FR6002, halogen free
Material note	Fire classification	Flammability V-0
Electronics	Rated voltage, bus	30 V DC
	Voltage range, bus	21 ... 31 V DC
	Current consumption, bus	< 12 mA
	Maximum current, device	24 × 6 A
	Power loss, device	≤ 7.5 W
	Power loss, bus	≤ 0.25 W
	KNX safety extra low voltage	SELV
Connections	Connection type, KNX bus	Plug-in terminal
	Cable diameter, KNX bus	0.6 ... 0.8 mm, solid
	Connection type, load circuit	Screw terminal with universal head (PZ 1)
	Pitch	6.35 mm
	Tightening torque, screw terminals	0.5 ... 0.6 Nm
	Conductor cross-section, flexible	1 × (0.2 ... 4 mm ²) / 2 × (0.2 ... 2.5 mm ²)
	Conductor cross section, rigid	1 × (0.2 ... 6 mm ²) / 2 × (0.2 ... 4 mm ²)
	Conductor cross section with wire end ferrule without plastic sleeve	1 × (0.25 ... 2.5 mm ²)
	Conductor cross section with wire end ferrule with plastic sleeve	1 × (0.25 ... 4 mm ²)
Certificates and declarations	Conductor cross section with TWIN wire end ferrule	1 × (0.5 ... 2.5 mm ²)
	Declaration of conformity CE	→ 2CDK505210D2701
Ambient conditions	Length, wire end ferrule contact pin	≥ 10 mm
	Operation	-5 ... +45 °C
	Transport	-25 ... +70 °C
	Storage	-25 ... +55 °C
	Humidity	≤ 95 %
	Condensation allowed	No
Atmospheric pressure	≥ 80 kPa (corresponds to air pressure at 2,000 m above sea level)	

Tab. 20: General technical data

3.7.4.2 Outputs – relays 6 A







Rated values	Number of outputs	24 switch/12 shutter
	Rated voltage U_n	230 V AC
	Rated current I_n (per output)	6 A
	Rated frequency	50/60 Hz
	Relay type	Bi-stable
Switching currents	AC-1 operation ($\cos \varphi = 0.8$)	≤ 6 A
	AC-3 operation ($\cos \varphi = 0.45$)	≤ 6 A
	Switching current at 12 V AC	≥ 0.1 A
	Switching current at 24 V AC	≥ 0.1 A
	Switching current at 24 V DC (resistive load)	≤ 6 A
Service life	Mechanical service life	$\geq 10^6$ switching operations
	AC-1 operation ($\cos \varphi = 0.8$)	$\geq 10^5$ switching operations
	AC-3 operation ($\cos \varphi = 0.45$)	$\geq 6 \times 10^3$ switching operations
Switching operations	Switching operations per minute when one relay switches	≤ 120
	Switching operations per minute when all relays switch	≤ 5
Starting current	Starting current I_{peak} (150 μ s)	≤ 200 A
	Starting current I_{peak} (250 μ s)	≤ 160 A
	Starting current I_{peak} (600 μ s)	≤ 100 A

Tab. 21: Outputs – relays 6 A

Note

The starting current I_{peak} is the typical ballast load current that results during switching. Using the starting current I_{peak} , it is possible to calculate the maximum number of switchable ballasts at the Switch Actuator output → [Ballast calculation, Page 291](#).

3.7.4.2.1 Load table

Load type	Symbol	Max. load
Incandescent bulbs		1200 W
Fluorescent lamps uncompensated		800 W
Low-voltage halogen lamps inductive transformer		800 W
Low-voltage halogen lamps electronic transformer		1000 W
Low-voltage halogen lamps 230 V		1000 W
Mercury-vapor lamps uncompensated		1000 W
Mercury-vapor lamps parallel compensated		800 W
LED lamps		250 W
Rated motor power		1380 W

Tab. 24: Load table

3.7.4.3 Device type

Device type	Switch/Shutter Actuator	SAH/S 24.6.7.1
	Application	Switch/Shutter 24-fold 6 A / = current version number of the application
	Maximum number of Group Objects	610
	Maximum number of group addresses	1000
	Maximum number of assignments	1000

Tab. 22: Device type

i Note

Observe software information on the website → www.abb.com/knx.

i Note

The device may be protected with a BCU key in ETS. If a BCU key was assigned, the device cannot be read or programmed without it.

3.8 Switch/Shutter Actuator SAH/S 8.10.7.1, 8-fold, 10 A, MDRC



Fig. 10: Device illustration SAH/S 8.10.7.1

9PAA00000003614-Rev_A

3.8.1 Dimension drawing

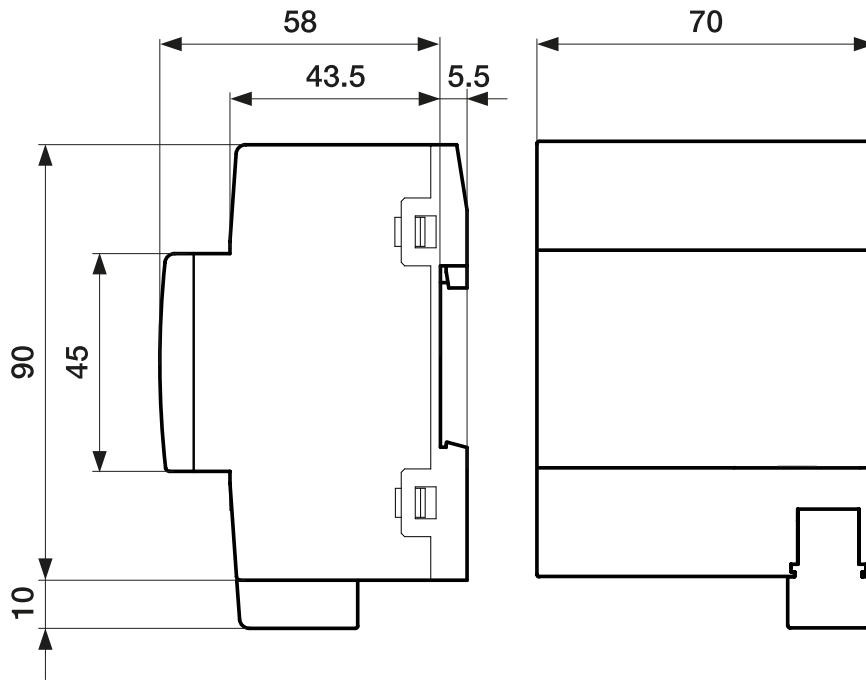

Fig. 11: Dimension drawing

2CDC072033F0015

3.8.2 Connection diagram

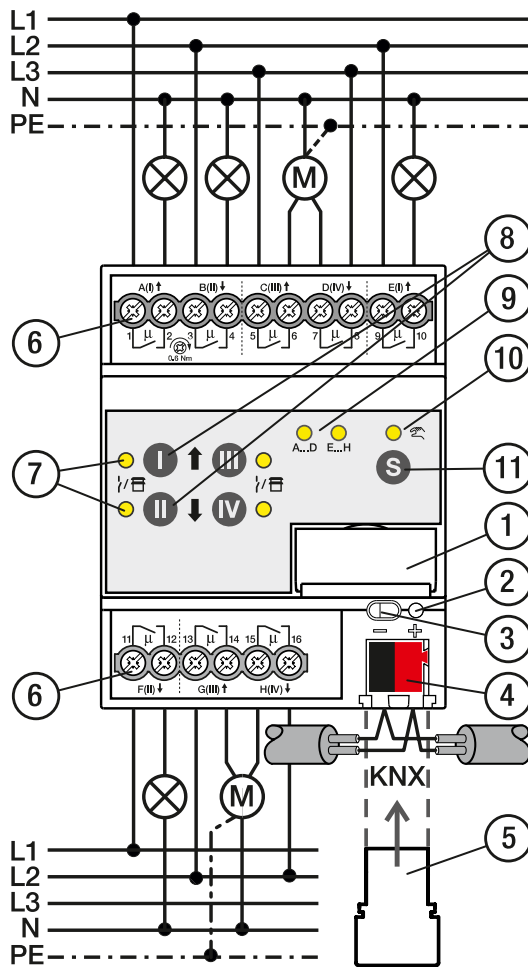

Fig. 12: Connection diagram SAH/S 8.x.7.1

Legend

- | | |
|--|-------------------------|
| 1 label carrier | 7 LED Output |
| 2 Programming LED | 8 Output button |
| 3 Programming button | 9 Group LED |
| 4 Bus connection terminal | 10 LED Manual operation |
| 5 Cover cap | 11 S button |
| 6 Load circuit, two screw terminals each | |

2CDC072006F0019

3.8.3 Operating and display elements



Note
 In *Shutter* mode, the function of the *Output* button/LEDs is identical for every shutter output pair. Only the buttons/LEDs I and II are described below.

Note
 In the KNX operation operating mode, it cannot be identified from the *Output LED* whether a switching output is blocked.

Operating control/LED	Description/function	Display
	Assignment of the physical address	LED On: Device in programming mode

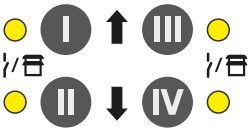

Programming button/LED
 Tab. 23: Operating and display elements

3.8.3.1 Manual mode

Operating control/LED	Description/function	Display
	Short button push < 2 s: Selection of relay group Button push 2 ... 5 s: Changeover to <i>KNX operation</i> Long button push > 5 s: Selection of all relays	LED On: <i>Manual operation</i> active LED Off: <i>KNX operation</i> active
		LED On: Group selected LED Off: Group not selected
	Switch Actuator application: Switching of the outputs (toggle function) Button I: First output of group (A/E) Button II: Second output of group (B/F) Button III: Third output of group (C/G) Button IV: Fourth output of group (D/H)	Switch Actuator application: LED On: Relay contact closed LED Off: Relay contact open LED flashing (1 Hz): Output blocked; manual operation not possible.
	Shutter Actuator application: Control of the shutter output pairs Button I: • Long button push > 1 s: Shutter Up • Short button push < 1 s: Shutter Stop/ slat adjustment Button II: • Long button push > 1 s: Shutter Down • Short button push < 1 s: Shutter Stop/ slat adjustment	Shutter Actuator application: LED I On and LED II Off: Upper end position LED I Off and LED II On: Lower end position LED I Off and LED II Off: Intermediate position LED I flashing (1 Hz) and LED II Off: Up movement LED I Off and LED II flashing (1 Hz): Down movement LED I flashing (1 Hz) and LED II flashing (1 Hz): Shutter output pair blocked LED I flashing (5 Hz) and LED II flashing (5 Hz): Shutter output pair active (after the group is changed or after change to <i>Manual operation</i> operating mode)

Tab. 24: Operating and display elements

3.8.3.2 KNX operation

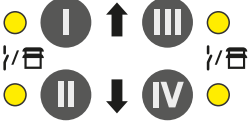
Operating control/LED	Description/function	Display
  <i>S button / Manual operation LED</i>	Short button push < 2 s: Selection of relay group Button push 2 ... 5 s: Change to <i>manual operation</i> Long button push > 5 s: Selection of all relays	LED On: <i>Manual operation</i> active LED Off: <i>KNX operation</i> active LED flashing (1 Hz) while button pressed: <i>Manual operation</i> not enabled or blocked
 <i>Group LED</i>		LED On: Group selected LED Off: Group not selected
 <i>Output button/LED</i>	Button without function	<p>Switch Actuator application: LED On: Relay contact closed LED Off: Relay contact open</p> <p>Shutter Actuator application: LED I On and LED II Off: Upper end position LED I Off and LED II On: Lower end position LED I Off and LED II Off: Intermediate position LED I flashing (1 Hz) and LED II Off: Up movement LED I Off and LED II flashing (1 Hz): Down movement LED I flashing (1 Hz) and LED II flashing (1 Hz): Shutter output pair blocked LED I flashing (5 Hz) and LED II flashing (5 Hz): Shutter output pair active (after the group is changed or after change to <i>KNX operation</i>)</p>

Tab. 25: Operating and display elements

3.8.4 Technical data

3.8.4.1 General technical data

Device	Dimensions	90 × 70 × 63.5 mm (H × W × D)
	Mounting width in space units	4 modules, 17.5 mm each
	Weight	0.27 kg
	Mounting position	Any
	Mounting variant	35 mm mounting rail
	Design	proM
	Degree of protection	IP 20
	Protection class	II
	Overvoltage category	III
	Pollution degree	2
Materials	Housing	Polycarbonate, Makrolon FR6002, halogen free
Material note	Fire classification	Flammability V-0
Electronics	Rated voltage, bus	30 V DC
	Voltage range, bus	21 ... 31 V DC
	Current consumption, bus	< 12 mA
	Maximum current, device	8 × 10 A
	Power loss, device	≤ 3 W
	Power loss, bus	≤ 0.25 W
	KNX safety extra low voltage	SELV
Connections	Connection type, KNX bus	Plug-in terminal
	Cable diameter, KNX bus	0.6 ... 0.8 mm, solid
	Connection type, load circuit	Screw terminal with universal head (PZ 1)
	Pitch	6.35 mm
	Tightening torque, screw terminals	0.5 ... 0.6 Nm
	Conductor cross-section, flexible	1 × (0.2 ... 4 mm ²) / 2 × (0.2 ... 2.5 mm ²)
	Conductor cross section, rigid	1 × (0.2 ... 6 mm ²) / 2 × (0.2 ... 4 mm ²)
	Conductor cross section with wire end ferrule without plastic sleeve	1 × (0.25 ... 2.5 mm ²)
	Conductor cross section with wire end ferrule with plastic sleeve	1 × (0.25 ... 4 mm ²)
	Conductor cross section with TWIN wire end ferrule	1 × (0.5 ... 2.5 mm ²)
Length, wire end ferrule contact pin	≥ 10 mm	
Certificates and declarations	Declaration of conformity CE	→ 2CDC505205D2701
Ambient conditions	Operation	-5 ... +45 °C
	Transport	-25 ... +70 °C
	Storage	-25 ... +55 °C
	Humidity	≤ 95 %
	Condensation allowed	No
	Atmospheric pressure	≥ 80 kPa (corresponds to air pressure at 2,000 m above sea level)

Tab. 26: General technical data

3.8.4.2 Outputs – relays 10 A







Rated values	Number of outputs	8 switch/4 shutter
	Rated voltage U_n	230 V AC
	Rated current I_n (per output)	10 A
	Rated frequency	50/60 Hz
	Relay type	Bi-stable
Switching currents	AC-1 operation ($\cos \varphi = 0.8$)	≤ 10 A
	AC-3 operation ($\cos \varphi = 0.45$)	≤ 6 A
	Switching current at 12 V AC	≥ 0.1 A
	Switching current at 24 V AC	≥ 0.1 A
	Switching current at 24 V DC (resistive load)	≤ 10 A
Service life	Mechanical service life	$\geq 10^6$ switching operations
	AC-1 operation ($\cos \varphi = 0.8$)	$\geq 10^5$ switching operations
	AC-3 operation ($\cos \varphi = 0.45$)	$\geq 6 \times 10^3$ switching operations
Switching operations	Switching operations per minute when one relay switches	≤ 120
	Switching operations per minute when all relays switch	≤ 15
Starting current	Starting current I_{peak} (150 μ s)	≤ 200 A
	Starting current I_{peak} (250 μ s)	≤ 160 A
	Starting current I_{peak} (600 μ s)	≤ 100 A

Tab. 27: Outputs – relays 10 A

Note

The starting current I_{peak} is the typical ballast load current that results during switching. Using the starting current I_{peak} , it is possible to calculate the maximum number of switchable ballasts at the Switch Actuator output → [Ballast calculation, Page 291](#).

3.8.4.2.1 Load table

Load type	Symbol	Max. load
Incandescent bulbs		1200 W
Fluorescent lamps uncompensated		800 W
Low-voltage halogen lamps inductive transformer		800 W
Low-voltage halogen lamps electronic transformer		1000 W
Low-voltage halogen lamps 230 V		1000 W
Mercury-vapor lamps uncompensated		1000 W
Mercury-vapor lamps parallel compensated		800 W
LED lamps		250 W
Rated motor power		1380 W

Tab. 31: Load table

3.8.4.3 Device type

Device type	Switch/Shutter Actuator	SAH/S 8.10.7.1
	Application	Switch/Shutter 8-fold 10 A / = current version number of the application
	Maximum number of Group Objects	282
	Maximum number of group addresses	1000
	Maximum number of assignments	1000

Tab. 28: Device type

i Note

Observe software information on the website → www.abb.com/knx.

i Note

The device may be protected with a BCU key in ETS. If a BCU key was assigned, the device cannot be read or programmed without it.

3.9 Switch/Shutter Actuator SAH/S 16.10.7.1, 16-fold, 10 A, MDRC



Fig. 13: Device illustration SAH/S 16.10.7.1

9PAA00000003616-Rev_A

3.9.1 Dimension drawing

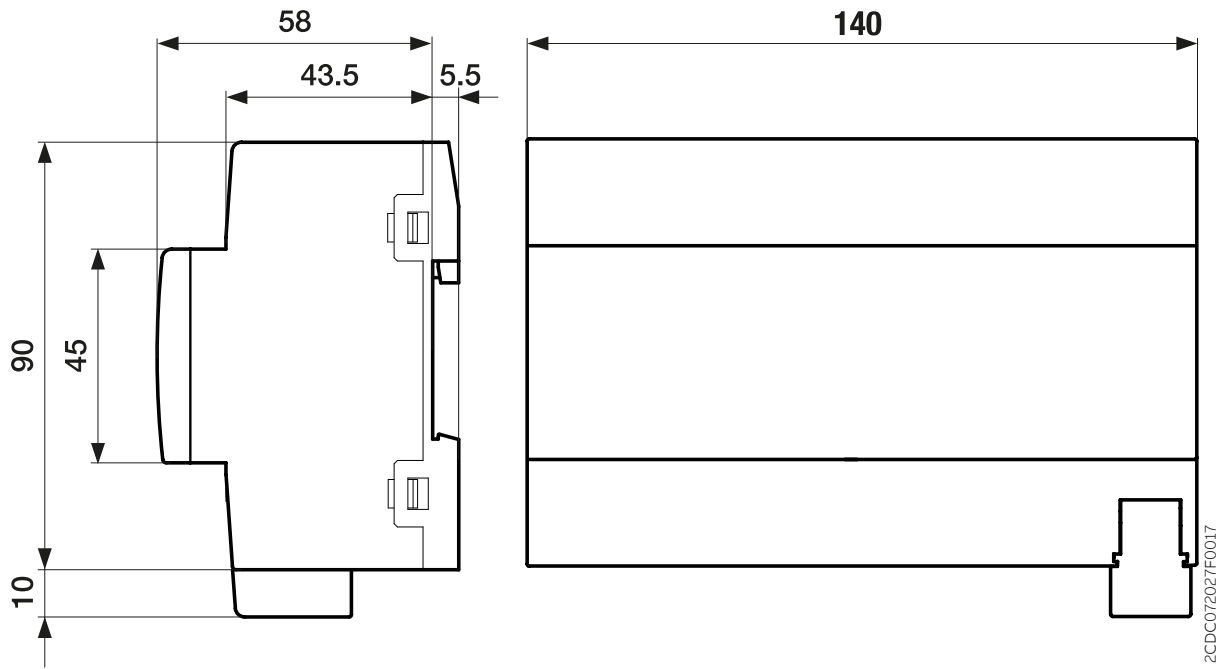

Fig. 14: Dimension drawing

3.9.2 Connection diagram

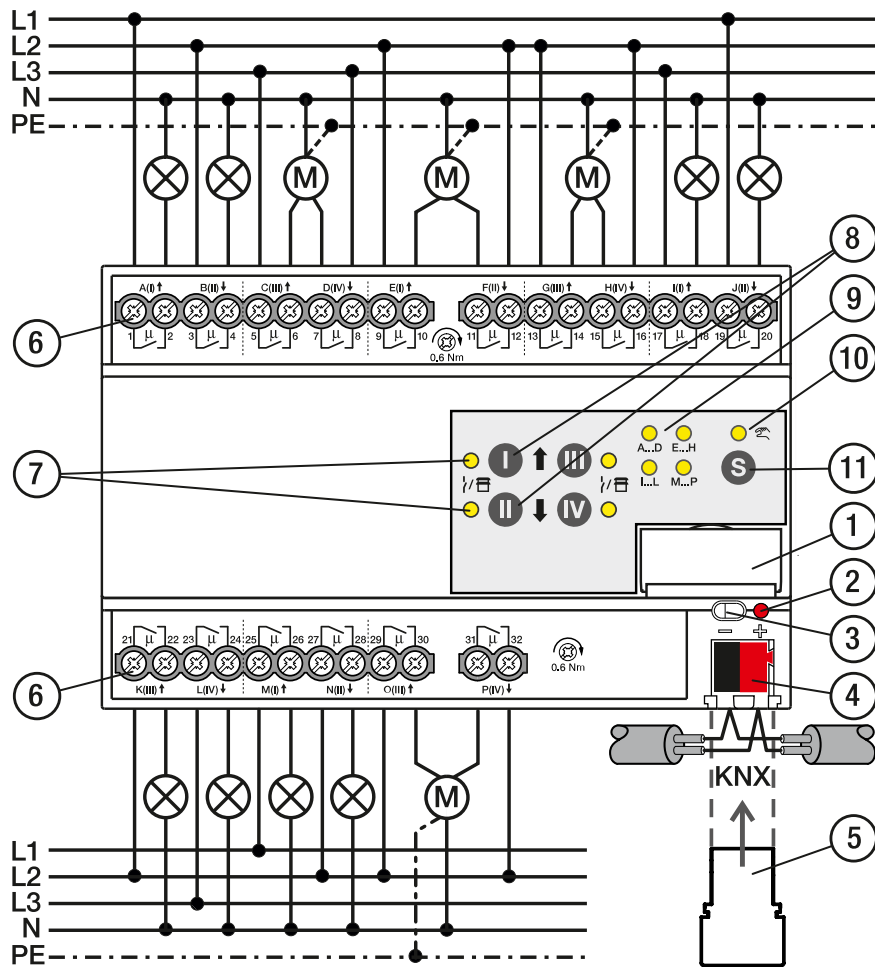

Fig. 15: Connection diagram SAH/S 16.x.7.1

Legend

- | | |
|--|-------------------------|
| 1 label carrier | 7 LED Output |
| 2 Programming LED | 8 Output button |
| 3 Programming button | 9 Group LED |
| 4 Bus connection terminal | 10 LED Manual operation |
| 5 Cover cap | 11 S button |
| 6 Load circuit, two screw terminals each | |

2CDC072007F0019

3.9.3 Operating and display elements



Note
 In *Shutter* mode, the function of the *Output* button/LEDs is identical for every shutter output pair. Only the buttons/LEDs I and II are described below.

Note
 In the KNX operation operating mode, it cannot be identified from the *Output LED* whether a switching output is blocked.

Operating control/LED	Description/function	Display
	Assignment of the physical address	LED On: Device in programming mode



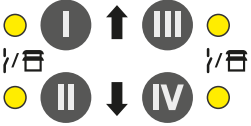

Tab. 29: Operating and display elements

3.9.3.1 Manual mode

Operating control/LED	Description/function	Display
 	Short button push < 2 s: Selection of relay group Button push 2 ... 5 s: Changeover to <i>KNX operation</i> Long button push > 5 s: Selection of all relays	LED On: <i>Manual operation</i> active LED Off: <i>KNX operation</i> active
 A...D E...H I...L M...P Group LED		LED On: Group selected LED Off: Group not selected
 Output button/LED	Switch Actuator application: Switching of the outputs (toggle function) Button I: First output of group (A/E/I/M) Button II: Second output of group (B/F/J/N) Button III: Third output of group (C/G/K/O) Button IV: Fourth output of group (D/H/L/P) Shutter Actuator application: Control of the shutter output pairs Button I: • Long button push > 1 s: Shutter Up • Short button push < 1 s: Shutter Stop/slat adjustment Button II: • Long button push > 1 s: Shutter Down • Short button push < 1 s: Shutter Stop/slat adjustment	Switch Actuator application: LED On: Relay contact closed LED Off: Relay contact open LED flashing (1 Hz): Output blocked; manual operation not possible. Shutter Actuator application: LED I On and LED II Off: Upper end position LED I Off and LED II On: Lower end position LED I Off and LED II Off: Intermediate position LED I flashing (1 Hz) and LED II Off: Up movement LED I Off and LED II flashing (1 Hz): Down movement LED I flashing (1 Hz) and LED II flashing (1 Hz): Shutter output pair blocked LED I flashing (5 Hz) and LED II flashing (5 Hz): Shutter output pair active (after the group is changed or after change to <i>Manual operation</i> operating mode)

Tab. 30: Operating and display elements

3.9.3.2 KNX operation

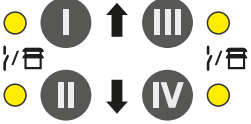
Operating control/LED	Description/function	Display
  <i>S button / Manual operation LED</i>	Short button push < 2 s: Selection of relay group Button push 2 ... 5 s: Change to <i>manual operation</i> Long button push > 5 s: Selection of all relays	LED On: <i>Manual operation</i> active LED Off: <i>KNX operation</i> active LED flashing (1 Hz) while button pressed: <i>Manual operation</i> not enabled or blocked
  <i>Group LED</i>		LED On: Group selected LED Off: Group not selected
 <i>Output button/LED</i>	Button without function	<p>Switch Actuator application: LED On: Relay contact closed LED Off: Relay contact open</p> <p>Shutter Actuator application: LED I On and LED II Off: Upper end position LED I Off and LED II On: Lower end position LED I Off and LED II Off: Intermediate position LED I flashing (1 Hz) and LED II Off: Up movement LED I Off and LED II flashing (1 Hz): Down movement LED I flashing (1 Hz) and LED II flashing (1 Hz): Shutter output pair blocked LED I flashing (5 Hz) and LED II flashing (5 Hz): Shutter output pair active (after the group is changed or after change to <i>KNX operation</i>)</p>

Tab. 31: Operating and display elements

3.9.4 Technical data

3.9.4.1 General technical data

Device	Dimensions	90 × 140 × 63.5 mm (H x W x D)
	Mounting width in space units	8 modules, 17.5 mm each
	Weight	0.5 kg
	Mounting position	Any
	Mounting variant	35 mm mounting rail
	Design	proM
	Degree of protection	IP 20
	Protection class	II
	Overvoltage category	III
	Pollution degree	2
Materials	Housing	Polycarbonate, Makrolon FR6002, halogen free
Material note	Fire classification	Flammability V-0
Electronics	Rated voltage, bus	30 V DC
	Voltage range, bus	21 ... 31 V DC
	Current consumption, bus	< 12 mA
	Maximum current, device	16 × 10 A
	Power loss, device	≤ 6 W
	Power loss, bus	≤ 0.25 W
	KNX safety extra low voltage	SELV
Connections	Connection type, KNX bus	Plug-in terminal
	Cable diameter, KNX bus	0.6 ... 0.8 mm, solid
	Connection type, load circuit	Screw terminal with universal head (PZ 1)
	Pitch	6.35 mm
	Tightening torque, screw terminals	0.5 ... 0.6 Nm
	Conductor cross-section, flexible	1 × (0.2 ... 4 mm ²) / 2 × (0.2 ... 2.5 mm ²)
	Conductor cross section, rigid	1 × (0.2 ... 6 mm ²) / 2 × (0.2 ... 4 mm ²)
	Conductor cross section with wire end ferrule without plastic sleeve	1 × (0.25 ... 2.5 mm ²)
	Conductor cross section with wire end ferrule with plastic sleeve	1 × (0.25 ... 4 mm ²)
	Conductor cross section with TWIN wire end ferrule	1 × (0.5 ... 2.5 mm ²)
Length, wire end ferrule contact pin	≥ 10 mm	
Certificates and declarations	Declaration of conformity CE	→ 2CDK505208D2701
Ambient conditions	Operation	-5 ... +45 °C
	Transport	-25 ... +70 °C
	Storage	-25 ... +55 °C
	Humidity	≤ 95 %
	Condensation allowed	No
	Atmospheric pressure	≥ 80 kPa (corresponds to air pressure at 2,000 m above sea level)

Tab. 32: General technical data







3.9.4.2 Outputs – relays 10 A

Rated values	Number of outputs	16 switch/8 shutter
	Rated voltage U_n	230 V AC
	Rated current I_n (per output)	10 A
	Rated frequency	50/60 Hz
	Relay type	Bi-stable
Switching currents	AC-1 operation ($\cos \varphi = 0.8$)	≤ 10 A
	AC-3 operation ($\cos \varphi = 0.45$)	≤ 6 A
	Switching current at 12 V AC	≥ 0.1 A
	Switching current at 24 V AC	≥ 0.1 A
	Switching current at 24 V DC (resistive load)	≤ 10 A
Service life	Mechanical service life	$\geq 10^6$ switching operations
	AC-1 operation ($\cos \varphi = 0.8$)	$\geq 10^5$ switching operations
	AC-3 operation ($\cos \varphi = 0.45$)	$\geq 6 \times 10^3$ switching operations
Switching operations	Switching operations per minute when one relay switches	≤ 120
	Switching operations per minute when all relays switch	≤ 7
Starting current	Starting current I_{peak} (150 μ s)	≤ 200 A
	Starting current I_{peak} (250 μ s)	≤ 160 A
	Starting current I_{peak} (600 μ s)	≤ 100 A

Tab. 33: Outputs – relays 10 A

Note
 The starting current I_{peak} is the typical ballast load current that results during switching. Using the starting current I_{peak} , it is possible to calculate the maximum number of switchable ballasts at the Switch Actuator output → [Ballast calculation, Page 291](#).

3.9.4.2.1 Load table

Load type	Symbol	Max. load
Incandescent bulbs		1200 W
Fluorescent lamps uncompensated		800 W
Low-voltage halogen lamps inductive transformer		800 W
Low-voltage halogen lamps electronic transformer		1000 W
Low-voltage halogen lamps 230 V		1000 W
Mercury-vapor lamps uncompensated		1000 W
Mercury-vapor lamps parallel compensated		800 W
LED lamps		250 W
Rated motor power		1380 W

Tab. 38: Load table

3.9.4.3 Device type

Device type	Switch/Shutter Actuator	SAH/S 16.10.7.1
	Application	Switch/Shutter 16-fold 10 A / ...
		... = current version number of the application
	Maximum number of Group Objects	446
	Maximum number of group addresses	1000
	Maximum number of assignments	1000

Tab. 34: Device type

i Note

Observe software information on the website → www.abb.com/knx.

i Note

The device may be protected with a BCU key in ETS. If a BCU key was assigned, the device cannot be read or programmed without it.

3.10 Switch/Shutter Actuator SAH/S 24.10.7.1, 24-fold, 10 A, MDRC



Fig. 16: Device illustration SAH/S 24.10.7.1

9PAA0000003639-Rev_A

3.10.1 Dimension drawing

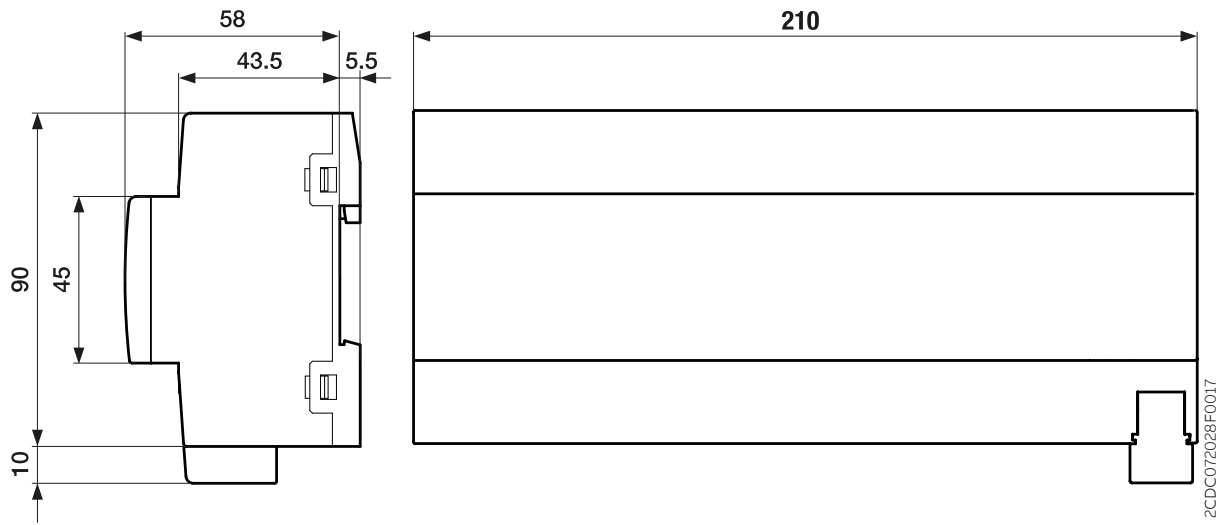

Fig. 17: Dimension drawing

3.10.2

Connection diagram

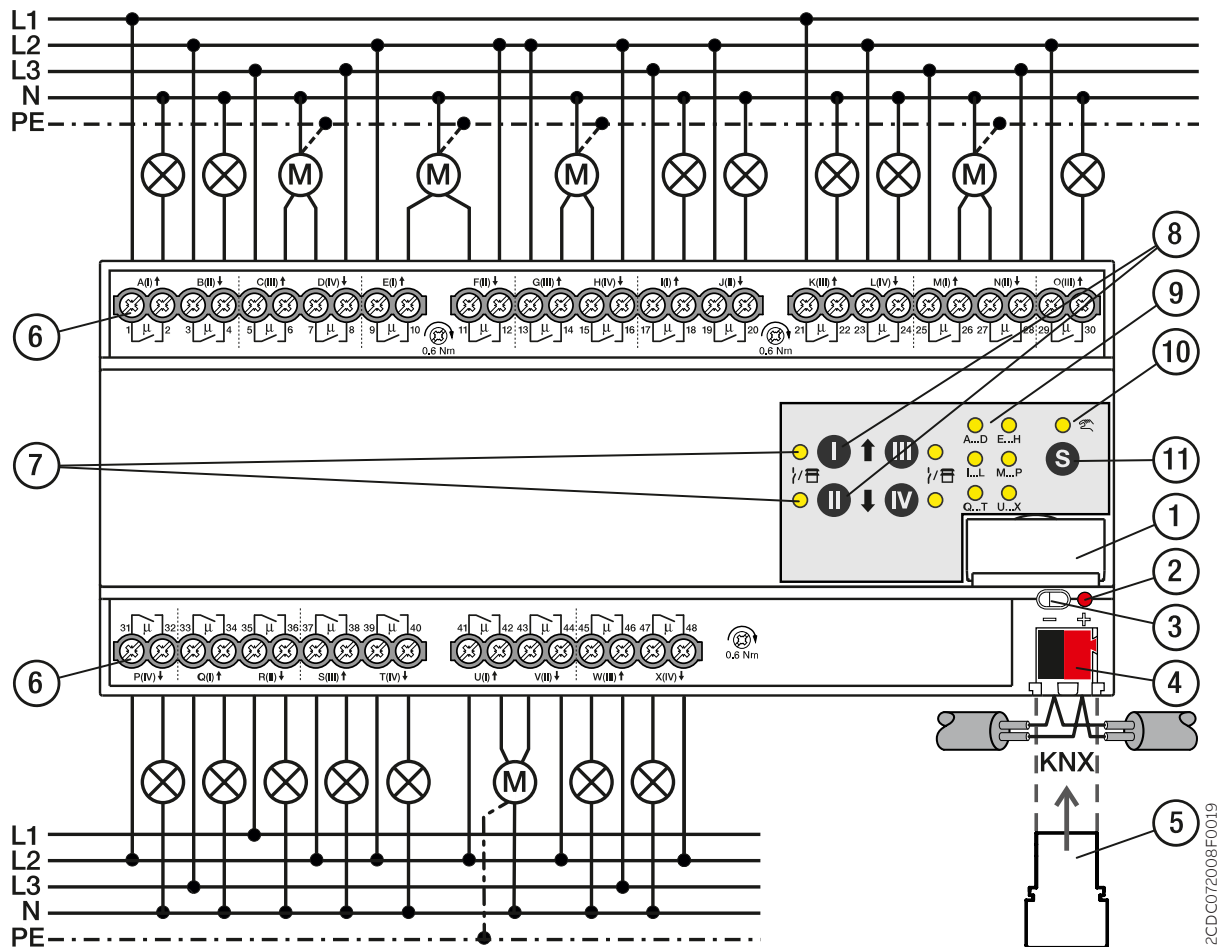

Fig. 18: Connection diagram SAH/S 24.x.7.1

Legend

- | | |
|--|-------------------------|
| 1 label carrier | 7 LED Output |
| 2 Programming LED | 8 Output button |
| 3 Programming button | 9 Group LED |
| 4 Bus connection terminal | 10 LED Manual operation |
| 5 Cover cap | 11 S button |
| 6 Load circuit, two screw terminals each | |

3.10.3 Operating and display elements

Note

In *Shutter* mode, the function of the *Output* button/LEDs is identical for every shutter output pair. Only the buttons/LEDs I and II are described below.

Note

In the KNX operation operating mode, it cannot be identified from the *Output LED* whether a switching output is blocked.



Operating control/LED	Description/function	Display
	Assignment of the physical address	LED On: Device in programming mode

Programming button/LED

Tab. 35: Operating and display elements

3.10.3.1 Manual mode

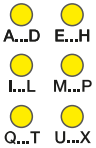
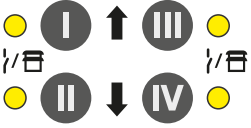

Manual mode

Operating control/LED	Description/function	Display
	Short button push < 2 s: Selection of relay group	LED On: <i>Manual operation</i> active LED Off: <i>KNX operation</i> active
	Button push 2 ... 5 s: Changeover to <i>KNX operation</i> Long button push > 5 s: Selection of all relays	
<i>S button / Manual operation LED</i>		
		LED On: Group selected LED Off: Group not selected
<i>Group LED</i>		
	Switch Actuator application: Switching of the outputs (toggle function) Button I: First output of group (A/E/I/M/Q/U) Button II: Second output of group (B/F/J/N/R/V) Button III: Third output of group (C/G/K/O/S/W) Button IV: Fourth output of group (D/H/L/P/T/X)	Switch Actuator application: LED On: Relay contact closed LED Off: Relay contact open LED flashing (1 Hz): Output blocked; manual operation not possible.
<i>Output button/LED</i>	Shutter Actuator application: Control of the shutter output pairs Button I: <ul style="list-style-type: none"> Long button push > 1 s: Shutter Up Short button push < 1 s: Shutter Stop/ slat adjustment Button II: <ul style="list-style-type: none"> Long button push > 1 s: Shutter Down Short button push < 1 s: Shutter Stop/ slat adjustment 	Shutter Actuator application: LED I On and LED II Off: Upper end position LED I Off and LED II On: Lower end position LED I Off and LED II Off: Intermediate position LED I flashing (1 Hz) and LED II Off: Up movement LED I Off and LED II flashing (1 Hz): Down movement LED I flashing (1 Hz) and LED II flashing (1 Hz): Shutter output pair blocked LED I flashing (5 Hz) and LED II flashing (5 Hz): Shutter output pair active (after the group is changed or after change to <i>Manual operation</i> operating mode)

Tab. 36: Operating and display elements

3.10.3.2

KNX operation

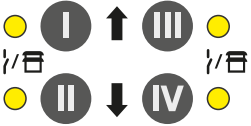
Operating control/LED	Description/function	Display
  <i>S button / Manual operation LED</i>	Short button push < 2 s: Selection of relay group Button push 2 ... 5 s: Change to <i>manual operation</i> Long button push > 5 s: Selection of all relays	LED On: <i>Manual operation</i> active LED Off: <i>KNX operation</i> active LED flashing (1 Hz) while button pressed: <i>Manual operation</i> not enabled or blocked
 <i>Group LED</i>		LED On: Group selected LED Off: Group not selected
 <i>Output button/LED</i>	Button without function	<p>Switch Actuator application: LED On: Relay contact closed LED Off: Relay contact open</p> <p>Shutter Actuator application: LED I On and LED II Off: Upper end position LED I Off and LED II On: Lower end position LED I Off and LED II Off: Intermediate position LED I flashing (1 Hz) and LED II Off: Up movement LED I Off and LED II flashing (1 Hz): Down movement LED I flashing (1 Hz) and LED II flashing (1 Hz): Shutter output pair blocked LED I flashing (5 Hz) and LED II flashing (5 Hz): Shutter output pair active (after the group is changed or after change to <i>KNX operation</i>)</p>

Tab. 37: Operating and display elements

3.10.4 Technical data

3.10.4.1 General technical data

Device	Dimensions	90 × 210 × 63.5 mm (H x W x D)
	Mounting width in space units	12 modules, 17.5 mm each
	Weight	0.72 kg
	Mounting position	Any
	Mounting variant	35 mm mounting rail
	Design	proM
	Degree of protection	IP 20
	Protection class	II
	Overvoltage category	III
	Pollution degree	2
Materials	Housing	Polycarbonate, Makrolon FR6002, halogen free
Material note	Fire classification	Flammability V-0
Electronics	Rated voltage, bus	30 V DC
	Voltage range, bus	21 ... 31 V DC
	Current consumption, bus	< 12 mA
	Maximum current, device	200 A
	Power loss, device	≤ 9 W
	Power loss, bus	≤ 0.25 W
	KNX safety extra low voltage	SELV
Connections	Connection type, KNX bus	Plug-in terminal
	Cable diameter, KNX bus	0.6 ... 0.8 mm, solid
	Connection type, load circuit	Screw terminal with universal head (PZ 1)
	Pitch	6.35 mm
	Tightening torque, screw terminals	0.5 ... 0.6 Nm
	Conductor cross-section, flexible	1 × (0.2 ... 4 mm ²) / 2 × (0.2 ... 2.5 mm ²)
	Conductor cross section, rigid	1 × (0.2 ... 6 mm ²) / 2 × (0.2 ... 4 mm ²)
	Conductor cross section with wire end ferrule without plastic sleeve	1 × (0.25 ... 2.5 mm ²)
	Conductor cross section with wire end ferrule with plastic sleeve	1 × (0.25 ... 4 mm ²)
	Conductor cross section with TWIN wire end ferrule	1 × (0.5 ... 2.5 mm ²)
Length, wire end ferrule contact pin	≥ 10 mm	
Certificates and declarations	Declaration of conformity CE	→ 2CDK505211D2701
Ambient conditions	Operation	-5 ... +45 °C
	Transport	-25 ... +70 °C
	Storage	-25 ... +55 °C
	Humidity	≤ 95 %
	Condensation allowed	No
	Atmospheric pressure	≥ 80 kPa (corresponds to air pressure at 2,000 m above sea level)

Tab. 38: General technical data

3.10.4.2 Outputs – relays 10 A







Rated values	Number of outputs	24 switch/12 shutter
	Rated voltage U_n	230 V AC
	Rated current I_n (per output)	10 A
	Rated frequency	50/60 Hz
	Relay type	Bi-stable
Switching currents	AC-1 operation ($\cos \varphi = 0.8$)	≤ 10 A
	AC-3 operation ($\cos \varphi = 0.45$)	≤ 6 A
	Switching current at 12 V AC	≥ 0.1 A
	Switching current at 24 V AC	≥ 0.1 A
	Switching current at 24 V DC (resistive load)	≤ 10 A
Service life	Mechanical service life	$\geq 10^6$ switching operations
	AC-1 operation ($\cos \varphi = 0.8$)	$\geq 10^5$ switching operations
	AC-3 operation ($\cos \varphi = 0.45$)	$\geq 6 \times 10^3$ switching operations
Switching operations	Switching operations per minute when one relay switches	≤ 120
	Switching operations per minute when all relays switch	≤ 5
Starting current	Starting current I_{peak} (150 μ s)	≤ 200 A
	Starting current I_{peak} (250 μ s)	≤ 160 A
	Starting current I_{peak} (600 μ s)	≤ 100 A

Tab. 39: Outputs – relays 10 A

Note

The starting current I_{peak} is the typical ballast load current that results during switching. Using the starting current I_{peak} , it is possible to calculate the maximum number of switchable ballasts at the Switch Actuator output → [Ballast calculation, Page 291](#).

3.10.4.2.1 Load table

Load type	Symbol	Max. load
Incandescent bulbs		1200 W
Fluorescent lamps uncompensated		800 W
Low-voltage halogen lamps inductive transformer		800 W
Low-voltage halogen lamps electronic transformer		1000 W
Low-voltage halogen lamps 230 V		1000 W
Dulux lamps uncompensated		800 W
Dulux lamps parallel compensated		800 W
Mercury-vapor lamps uncompensated		1000 W
Mercury-vapor lamps parallel compensated		800 W
LED lamps		250 W
Rated motor power		1380 W

Tab. 45: Load table

3.10.4.3 Device type

Device type	Switch/Shutter Actuator	SAH/S 24.10.7.1
	Application	Switch/Shutter 24-fold 10 A / ...
		... = current version number of the application
	Maximum number of Group Objects	610
	Maximum number of group addresses	1000
	Maximum number of assignments	1000

Tab. 40: Device type

i Note

Observe software information on the website → www.abb.com/knx.

i Note

The device may be protected with a BCU key in ETS. If a BCU key was assigned, the device cannot be read or programmed without it.

3.11 Switch/Shutter Actuator SAH/S 8.16.7.1, 8-fold, 16 A, MDRC



Fig. 19: Device illustration SAH/S 8.16.7.1

9PAA00000003628-Rev_A

3.11.1

Dimension drawing

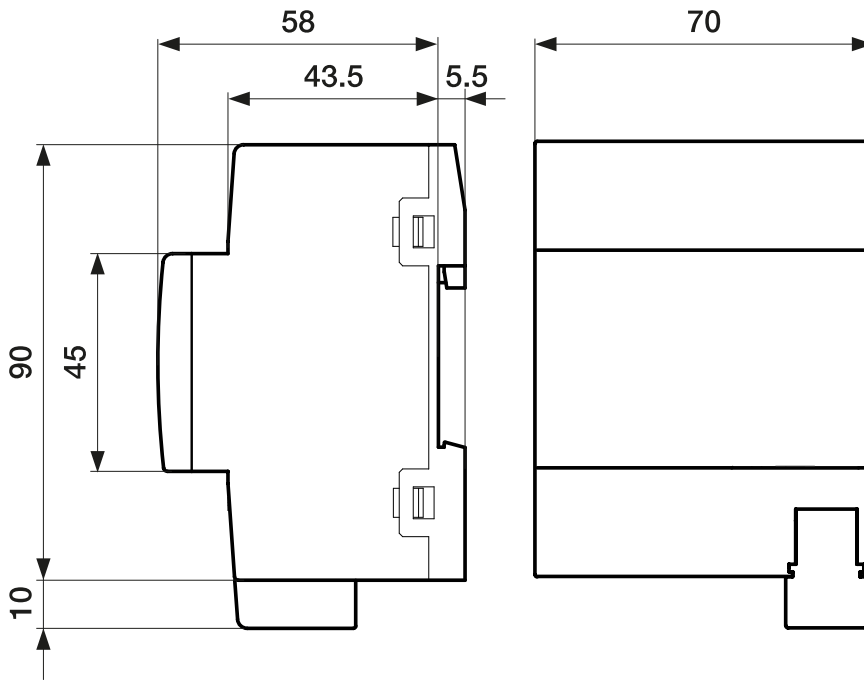

Fig. 20: Dimension drawing

2CDC072033F0015

3.11.2 Connection diagram

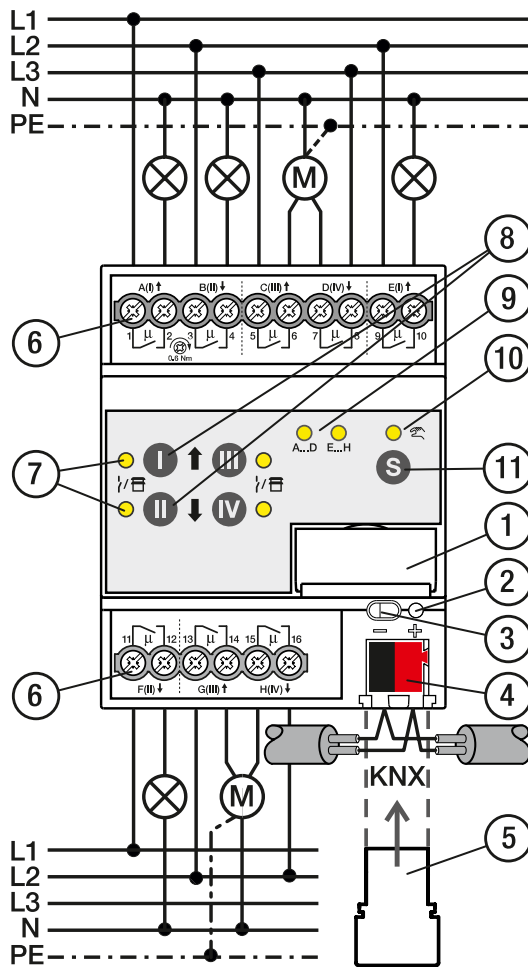

Fig. 21: Connection diagram SAH/S 8.x.7.1

Legend

- | | |
|--|-------------------------|
| 1 label carrier | 7 LED Output |
| 2 Programming LED | 8 Output button |
| 3 Programming button | 9 Group LED |
| 4 Bus connection terminal | 10 LED Manual operation |
| 5 Cover cap | 11 S button |
| 6 Load circuit, two screw terminals each | |

2CDC072006F0019

3.11.3 Operating and display elements

Note

In *Shutter* mode, the function of the *Output* button/LEDs is identical for every shutter output pair. Only the buttons/LEDs I and II are described below.



Note

In the KNX operation operating mode, it cannot be identified from the *Output LED* whether a switching output is blocked.

Operating control/LED	Description/function	Display
	Assignment of the physical address	LED On: Device in programming mode
<i>Programming button/LED</i>		

Tab. 41: Operating and display elements

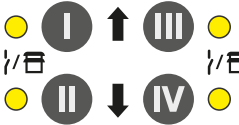

3.11.3.1 Manual mode

Operating control/LED	Description/function	Display
	Short button push < 2 s: Selection of relay group Button push 2 ... 5 s: Changeover to <i>KNX operation</i> Long button push > 5 s: Selection of all relays	LED On: <i>Manual operation</i> active LED Off: <i>KNX operation</i> active
<i>S button / Manual operation LED</i>		
		LED On: Group selected LED Off: Group not selected
<i>Group LED</i>		
	Switch Actuator application: Switching of the outputs (toggle function) Button I: First output of group (A/E) Button II: Second output of group (B/F) Button III: Third output of group (C/G) Button IV: Fourth output of group (D/H)	Switch Actuator application: LED On: Relay contact closed LED Off: Relay contact open LED flashing (1 Hz): Output blocked; manual operation not possible.
<i>Output button/LED</i>		
	Shutter Actuator application: Control of the shutter output pairs Button I: <ul style="list-style-type: none"> Long button push > 1 s: Shutter Up Short button push < 1 s: Shutter Stop/ slat adjustment Button II: <ul style="list-style-type: none"> Long button push > 1 s: Shutter Down Short button push < 1 s: Shutter Stop/ slat adjustment 	Shutter Actuator application: LED I On and LED II Off: Upper end position LED I Off and LED II On: Lower end position LED I Off and LED II Off: Intermediate position LED I flashing (1 Hz) and LED II Off: Up movement LED I Off and LED II flashing (1 Hz): Down movement LED I flashing (1 Hz) and LED II flashing (1 Hz): Shutter output pair blocked LED I flashing (5 Hz) and LED II flashing (5 Hz): Shutter output pair active (after the group is changed or after change to <i>Manual operation</i> operating mode)

Tab. 42: Operating and display elements

3.11.3.2

KNX operation

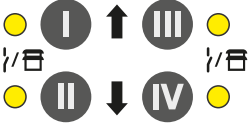
Operating control/LED	Description/function	Display
  <i>S button / Manual operation LED</i>	Short button push < 2 s: Selection of relay group Button push 2 ... 5 s: Change to <i>manual operation</i> Long button push > 5 s: Selection of all relays	LED On: <i>Manual operation</i> active LED Off: <i>KNX operation</i> active LED flashing (1 Hz) while button pressed: <i>Manual operation</i> not enabled or blocked
 <i>Group LED</i>		LED On: Group selected LED Off: Group not selected
 <i>Output button/LED</i>	Button without function	<p>Switch Actuator application: LED On: Relay contact closed LED Off: Relay contact open</p> <p>Shutter Actuator application: LED I On and LED II Off: Upper end position LED I Off and LED II On: Lower end position LED I Off and LED II Off: Intermediate position LED I flashing (1 Hz) and LED II Off: Up movement LED I Off and LED II flashing (1 Hz): Down movement LED I flashing (1 Hz) and LED II flashing (1 Hz): Shutter output pair blocked LED I flashing (5 Hz) and LED II flashing (5 Hz): Shutter output pair active (after the group is changed or after change to <i>KNX operation</i>)</p>

Tab. 43: Operating and display elements

3.11.4 Technical data

3.11.4.1 General technical data

Device	Dimensions	90 × 70 × 63.5 mm (H × W × D)
	Mounting width in space units	4 modules, 17.5 mm each
	Weight	0.27 kg
	Mounting position	Any
	Mounting variant	35 mm mounting rail
	Design	proM
	Degree of protection	IP 20
	Protection class	II
	Overvoltage category	III
	Pollution degree	2
Materials	Housing	Polycarbonate, Makrolon FR6002, halogen free
Material note	Fire classification	Flammability V-0
Electronics	Rated voltage, bus	30 V DC
	Voltage range, bus	21 ... 31 V DC
	Current consumption, bus	< 12 mA
	Maximum current, device	100 A
	Power loss, device	≤ 4 W
	Power loss, bus	≤ 0.25 W
	KNX safety extra low voltage	SELV
Connections	Connection type, KNX bus	Plug-in terminal
	Cable diameter, KNX bus	0.6 ... 0.8 mm, solid
	Connection type, load circuit	Screw terminal with universal head (PZ 1)
	Pitch	6.35 mm
	Tightening torque, screw terminals	0.5 ... 0.6 Nm
	Conductor cross-section, flexible	1 × (0.2 ... 4 mm ²) / 2 × (0.2 ... 2.5 mm ²)
	Conductor cross section, rigid	1 × (0.2 ... 6 mm ²) / 2 × (0.2 ... 4 mm ²)
	Conductor cross section with wire end ferrule without plastic sleeve	1 × (0.25 ... 2.5 mm ²)
	Conductor cross section with wire end ferrule with plastic sleeve	1 × (0.25 ... 4 mm ²)
	Conductor cross section with TWIN wire end ferrule	1 × (0.5 ... 2.5 mm ²)
Length, wire end ferrule contact pin	≥ 10 mm	
Certificates and declarations	Declaration of conformity CE	→ 2CDK505206D2701
Ambient conditions	Operation	-5 ... +45 °C
	Transport	-25 ... +70 °C
	Storage	-25 ... +55 °C
	Humidity	≤ 95 %
	Condensation allowed	No
	Atmospheric pressure	≥ 80 kPa (corresponds to air pressure at 2,000 m above sea level)

Tab. 44: General technical data

3.11.4.2 Outputs – relays 16 A







Rated values	Number of outputs	8 switch/4 shutter
	Rated voltage U_n	230 V AC
	Rated current I_n (per output)	16 A
	Rated frequency	50/60 Hz
	Relay type	Bi-stable
Switching currents	AC-1 operation ($\cos \varphi = 0.8$)	≤ 16 A
	AC-3 operation ($\cos \varphi = 0.45$)	≤ 6 A
	Switching current at 12 V AC	≥ 0.1 A
	Switching current at 24 V AC	≥ 0.1 A
	Switching current at 24 V DC (resistive load)	≤ 16 A
Service life	Mechanical service life	$\geq 10^6$ switching operations
	AC-1 operation ($\cos \varphi = 0.8$)	$\geq 10^5$ switching operations
	AC-3 operation ($\cos \varphi = 0.45$)	$\geq 6 \times 10^3$ switching operations
Switching operations	Switching operations per minute when one relay switches	≤ 120
	Switching operations per minute when all relays switch	≤ 15
Starting current	Starting current I_{peak} (150 μ s)	≤ 200 A
	Starting current I_{peak} (250 μ s)	≤ 160 A
	Starting current I_{peak} (600 μ s)	≤ 100 A

Tab. 45: Outputs – relays 16 A

Note

The starting current I_{peak} is the typical ballast load current that results during switching. Using the starting current I_{peak} , it is possible to calculate the maximum number of switchable ballasts at the Switch Actuator output → [Ballast calculation, Page 291](#).

3.11.4.2.1 Load table

Load type	Symbol	Max. load
Incandescent bulbs		1200 W
Fluorescent lamps uncompensated		800 W
Low-voltage halogen lamps inductive transformer		800 W
Low-voltage halogen lamps electronic transformer		1000 W
Low-voltage halogen lamps 230 V		1000 W
Mercury-vapor lamps uncompensated		1000 W
Mercury-vapor lamps parallel compensated		800 W
LED lamps		250 W
Rated motor power		1380 W

Tab. 52: Load table

3.11.4.3 Device type

Device type	Switch/Shutter Actuator	SAH/S 8.16.7.1
	Application	Switch/Shutter 8-fold 16 A / = current version number of the application
	Maximum number of Group Objects	282
	Maximum number of group addresses	1000
	Maximum number of assignments	1000

Tab. 46: Device type

i Note

Observe software information on the website → www.abb.com/knx.

i Note

The device may be protected with a BCU key in ETS. If a BCU key was assigned, the device cannot be read or programmed without it.

3.12 Switch/Shutter Actuator SAH/S 16.16.7.1, 16-fold, 16 A, MDRC



Fig. 22: Device illustration SAH/S 16.16.7.1

9PAA0000003629-Rev_A

3.12.1 Dimension drawing

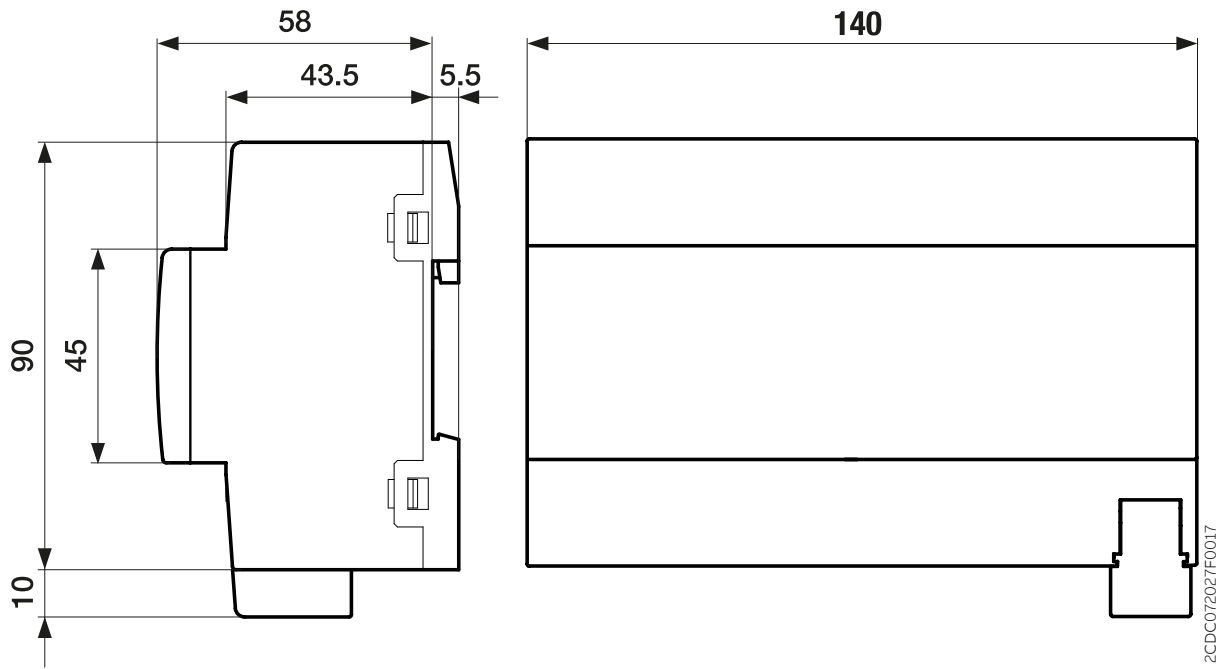

Fig. 23: Dimension drawing

3.12.2

Connection diagram

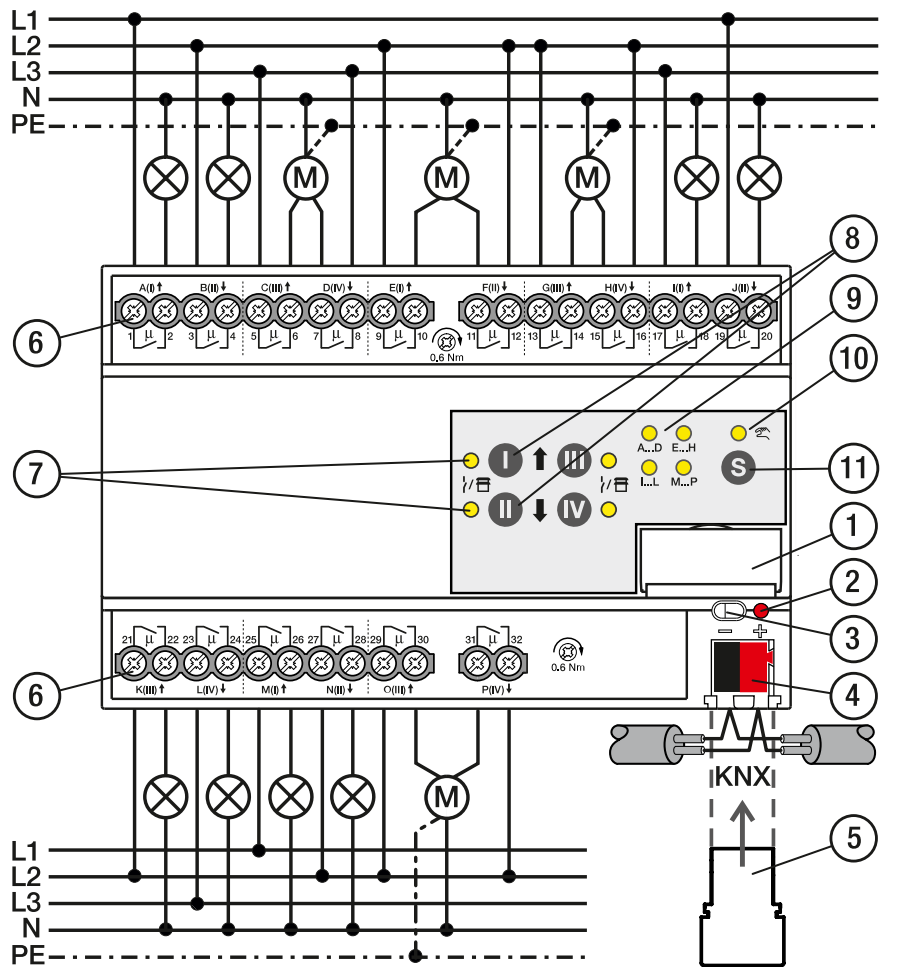

Fig. 24: Connection diagram SAH/S 16.x.7.1

Legend

- | | |
|--|-------------------------|
| 1 label carrier | 7 LED Output |
| 2 Programming LED | 8 Output button |
| 3 Programming button | 9 Group LED |
| 4 Bus connection terminal | 10 LED Manual operation |
| 5 Cover cap | 11 S button |
| 6 Load circuit, two screw terminals each | |

3.12.3 Operating and display elements

Note
 In *Shutter* mode, the function of the *Output* button/LEDs is identical for every shutter output pair. Only the buttons/LEDs I and II are described below.



Note
 In the KNX operation operating mode, it cannot be identified from the *Output LED* whether a switching output is blocked.

Operating control/LED	Description/function	Display
	Assignment of the physical address	LED On: Device in programming mode

Programming button/LED

Tab. 47: Operating and display elements



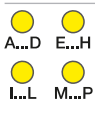
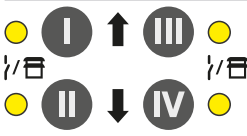

3.12.3.1 Manual mode

Operating control/LED	Description/function	Display
 	Short button push < 2 s: Selection of relay group Button push 2 ... 5 s: Changeover to <i>KNX operation</i> Long button push > 5 s: Selection of all relays	LED On: <i>Manual operation</i> active LED Off: <i>KNX operation</i> active
 <i>Group LED</i>		LED On: Group selected LED Off: Group not selected
 <i>Output button/LED</i>	Switch Actuator application: Switching of the outputs (toggle function) Button I: First output of group (A/E/I/M) Button II: Second output of group (B/F/J/N) Button III: Third output of group (C/G/K/O) Button IV: Fourth output of group (D/H/L/P) Shutter Actuator application: Control of the shutter output pairs Button I: • Long button push > 1 s: Shutter Up • Short button push < 1 s: Shutter Stop/slat adjustment Button II: • Long button push > 1 s: Shutter Down • Short button push < 1 s: Shutter Stop/slat adjustment	Switch Actuator application: LED On: Relay contact closed LED Off: Relay contact open LED flashing (1 Hz): Output blocked; manual operation not possible. Shutter Actuator application: LED I On and LED II Off: Upper end position LED I Off and LED II On: Lower end position LED I Off and LED II Off: Intermediate position LED I flashing (1 Hz) and LED II Off: Up movement LED I Off and LED II flashing (1 Hz): Down movement LED I flashing (1 Hz) and LED II flashing (1 Hz): Shutter output pair blocked LED I flashing (5 Hz) and LED II flashing (5 Hz): Shutter output pair active (after the group is changed or after change to <i>Manual operation</i> operating mode)

Tab. 48: Operating and display elements

3.12.3.2

KNX operation

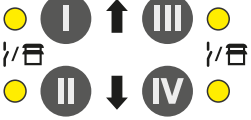
Operating control/LED	Description/function	Display
  <i>S button / Manual operation LED</i>	Short button push < 2 s: Selection of relay group Button push 2 ... 5 s: Change to <i>manual operation</i> Long button push > 5 s: Selection of all relays	LED On: <i>Manual operation</i> active LED Off: <i>KNX operation</i> active LED flashing (1 Hz) while button pressed: <i>Manual operation</i> not enabled or blocked
  <i>Group LED</i>		LED On: Group selected LED Off: Group not selected
 <i>Output button/LED</i>	Button without function	<p>Switch Actuator application: LED On: Relay contact closed LED Off: Relay contact open</p> <p>Shutter Actuator application: LED I On and LED II Off: Upper end position LED I Off and LED II On: Lower end position LED I Off and LED II Off: Intermediate position LED I flashing (1 Hz) and LED II Off: Up movement LED I Off and LED II flashing (1 Hz): Down movement LED I flashing (1 Hz) and LED II flashing (1 Hz): Shutter output pair blocked LED I flashing (5 Hz) and LED II flashing (5 Hz): Shutter output pair active (after the group is changed or after change to <i>KNX operation</i>)</p>

Tab. 49: Operating and display elements

3.12.4 Technical data

3.12.4.1 General technical data

Device	Dimensions	90 × 140 × 63.5 mm (H x W x D)
	Mounting width in space units	8 modules, 17.5 mm each
	Weight	0.5 kg
	Mounting position	Any
	Mounting variant	35 mm mounting rail
	Design	proM
	Degree of protection	IP 20
	Protection class	II
	Overvoltage category	III
	Pollution degree	2
Materials	Housing	Polycarbonate, Makrolon FR6002, halogen free
Material note	Fire classification	Flammability V-0
Electronics	Rated voltage, bus	30 V DC
	Voltage range, bus	21 ... 31 V DC
	Current consumption, bus	< 12 mA
	Maximum current, device	160 A
	Power loss, device	≤ 8 W
	Power loss, bus	≤ 0.25 W
	KNX safety extra low voltage	SELV
Connections	Connection type, KNX bus	Plug-in terminal
	Cable diameter, KNX bus	0.6 ... 0.8 mm, solid
	Connection type, load circuit	Screw terminal with universal head (PZ 1)
	Pitch	6.35 mm
	Tightening torque, screw terminals	0.5 ... 0.6 Nm
	Conductor cross-section, flexible	1 × (0.2 ... 4 mm ²) / 2 × (0.2 ... 2.5 mm ²)
	Conductor cross section, rigid	1 × (0.2 ... 6 mm ²) / 2 × (0.2 ... 4 mm ²)
	Conductor cross section with wire end ferrule without plastic sleeve	1 × (0.25 ... 2.5 mm ²)
	Conductor cross section with wire end ferrule with plastic sleeve	1 × (0.25 ... 4 mm ²)
	Conductor cross section with TWIN wire end ferrule	1 × (0.5 ... 2.5 mm ²)
Length, wire end ferrule contact pin	≥ 10 mm	
Certificates and declarations	Declaration of conformity CE	→ 2CDK505209D2701
Ambient conditions	Operation	-5 ... +45 °C
	Transport	-25 ... +70 °C
	Storage	-25 ... +55 °C
	Humidity	≤ 95 %
	Condensation allowed	No
	Atmospheric pressure	≥ 80 kPa (corresponds to air pressure at 2,000 m above sea level)

Tab. 50: General technical data

3.12.4.2 Outputs – relays 16 A







Rated values	Number of outputs	16 switch/8 shutter
	Rated voltage U_n	230 V AC
	Rated current I_n (per output)	16 A
	Rated frequency	50/60 Hz
	Relay type	Bi-stable
Switching currents	AC-1 operation ($\cos \varphi = 0.8$)	≤ 16 A
	AC-3 operation ($\cos \varphi = 0.45$)	≤ 6 A
	Switching current at 12 V AC	≥ 0.1 A
	Switching current at 24 V AC	≥ 0.1 A
	Switching current at 24 V DC (resistive load)	≤ 16 A
Service life	Mechanical service life	$\geq 10^6$ switching operations
	AC-1 operation ($\cos \varphi = 0.8$)	$\geq 10^5$ switching operations
	AC-3 operation ($\cos \varphi = 0.45$)	$\geq 6 \times 10^3$ switching operations
Switching operations	Switching operations per minute when one relay switches	≤ 120
	Switching operations per minute when all relays switch	≤ 7
Starting current	Starting current I_{peak} (150 μ s)	≤ 200 A
	Starting current I_{peak} (250 μ s)	≤ 160 A
	Starting current I_{peak} (600 μ s)	≤ 100 A

Tab. 51: Outputs – relays 16 A

Note

The starting current I_{peak} is the typical ballast load current that results during switching. Using the starting current I_{peak} , it is possible to calculate the maximum number of switchable ballasts at the Switch Actuator output → [Ballast calculation, Page 291](#).

3.12.4.2.1 Load table

Load type	Symbol	Max. load
Incandescent bulbs		1200 W
Fluorescent lamps uncompensated		800 W
Low-voltage halogen lamps inductive transformer		800 W
Low-voltage halogen lamps electronic transformer		1000 W
Low-voltage halogen lamps 230 V		1000 W
Mercury-vapor lamps uncompensated		1000 W
Mercury-vapor lamps parallel compensated		800 W
LED lamps		250 W
Rated motor power		1380 W

Tab. 59: Load table

3.12.4.3 Device type

Device type	Switch/Shutter Actuator	SAH/S 16.6.7.1
	Application	Switch/Shutter 16-fold 16 A / ...
		... = current version number of the application
	Maximum number of Group Objects	446
	Maximum number of group addresses	1000
	Maximum number of assignments	1000

Tab. 52: Device type

i Note

Observe software information on the website → www.abb.com/knx.

i Note

The device may be protected with a BCU key in ETS. If a BCU key was assigned, the device cannot be read or programmed without it.

3.13 Switch/Shutter Actuator SAH/S 24.16.7.1, 24-fold, 16 A, MDRC



Fig. 25: Device illustration SAH/S 24.16.7.1

9PAA0000003634-Rev_A

3.13.1

Dimension drawing

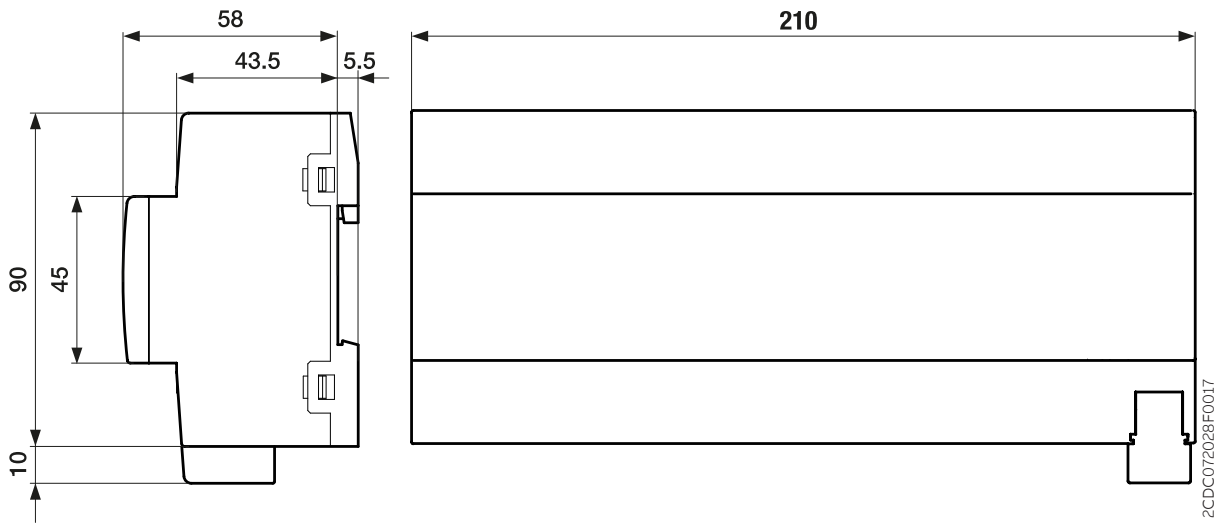

Fig. 26: Dimension drawing

3.13.2

Connection diagram

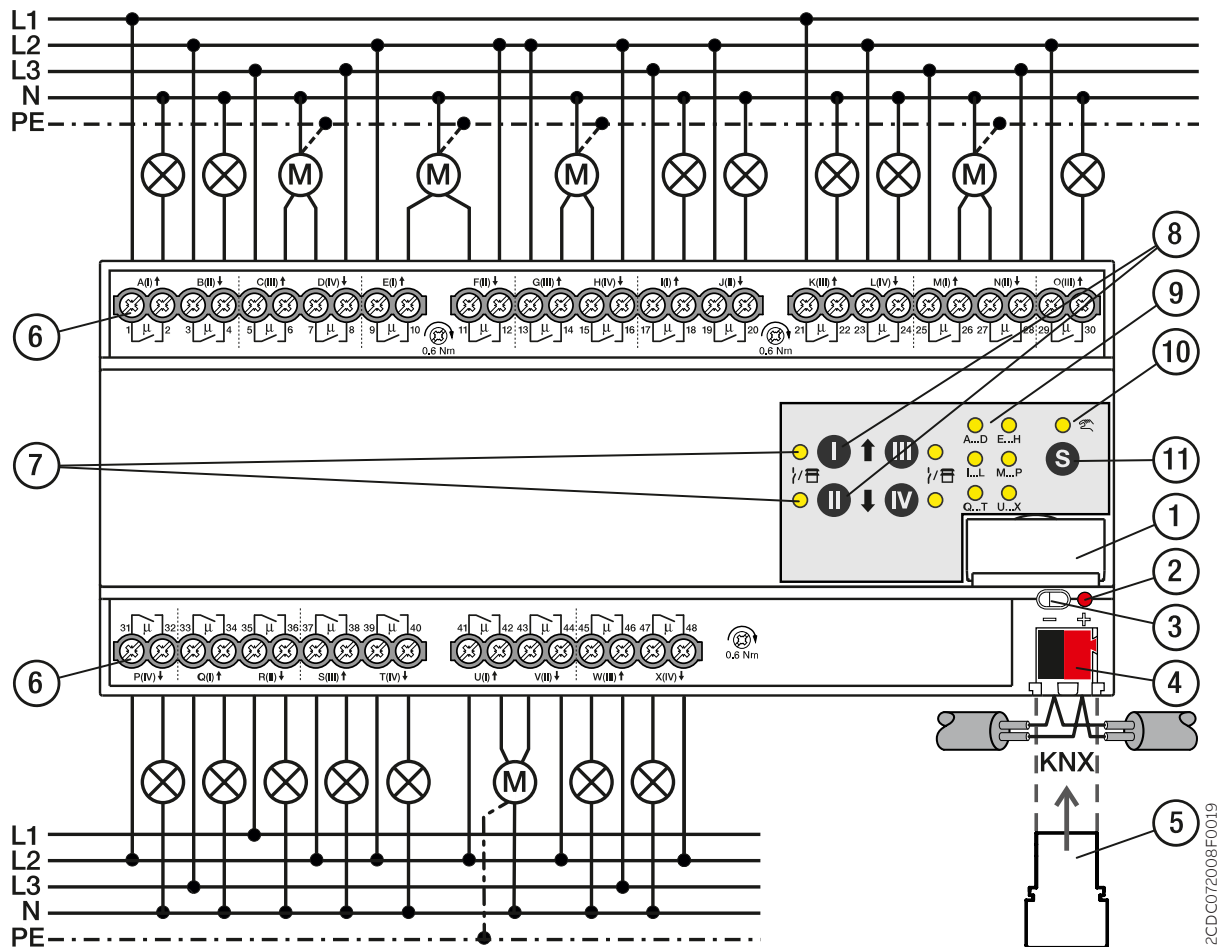

Fig. 27: Connection diagram SAH/S 24.x.7.1

Legend

- | | |
|--|-------------------------|
| 1 label carrier | 7 LED Output |
| 2 Programming LED | 8 Output button |
| 3 Programming button | 9 Group LED |
| 4 Bus connection terminal | 10 LED Manual operation |
| 5 Cover cap | 11 S button |
| 6 Load circuit, two screw terminals each | |

2CDC072008F0019

3.13.3 Operating and display elements

Note

In *Shutter* mode, the function of the *Output* button/LEDs is identical for every shutter output pair. Only the buttons/LEDs I and II are described below.

Note

In the KNX operation operating mode, it cannot be identified from the *Output LED* whether a switching output is blocked.



Operating control/LED	Description/function	Display
	Assignment of the physical address	LED On: Device in programming mode

Programming button/LED

Tab. 53: Operating and display elements

3.13.3.1

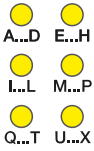
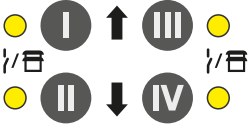

Manual mode

Operating control/LED	Description/function	Display
	Short button push < 2 s: Selection of relay group	LED On: <i>Manual operation</i> active LED Off: <i>KNX operation</i> active
	Button push 2 ... 5 s: Changeover to <i>KNX operation</i> Long button push > 5 s: Selection of all relays	
<i>S button / Manual operation LED</i>		
		LED On: Group selected LED Off: Group not selected
<i>Group LED</i>		
	Switch Actuator application: Switching of the outputs (toggle function) Button I: First output of group (A/E/I/M/Q/U) Button II: Second output of group (B/F/J/N/R/V) Button III: Third output of group (C/G/K/O/S/W) Button IV: Fourth output of group (D/H/L/P/T/X)	Switch Actuator application: LED On: Relay contact closed LED Off: Relay contact open LED flashing (1 Hz): Output blocked; manual operation not possible.
<i>Output button/LED</i>	Shutter Actuator application: Control of the shutter output pairs Button I: <ul style="list-style-type: none"> Long button push > 1 s: Shutter Up Short button push < 1 s: Shutter Stop/ slat adjustment Button II: <ul style="list-style-type: none"> Long button push > 1 s: Shutter Down Short button push < 1 s: Shutter Stop/ slat adjustment 	Shutter Actuator application: LED I On and LED II Off: Upper end position LED I Off and LED II On: Lower end position LED I Off and LED II Off: Intermediate position LED I flashing (1 Hz) and LED II Off: Up movement LED I Off and LED II flashing (1 Hz): Down movement LED I flashing (1 Hz) and LED II flashing (1 Hz): Shutter output pair blocked LED I flashing (5 Hz) and LED II flashing (5 Hz): Shutter output pair active (after the group is changed or after change to <i>Manual operation</i> operating mode)

Tab. 54: Operating and display elements

3.13.3.2

KNX operation

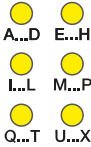
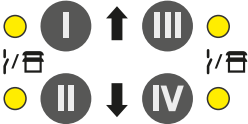
Operating control/LED	Description/function	Display
  <i>S button / Manual operation LED</i>	Short button push < 2 s: Selection of relay group Button push 2 ... 5 s: Change to <i>manual operation</i> Long button push > 5 s: Selection of all relays	LED On: <i>Manual operation</i> active LED Off: <i>KNX operation</i> active LED flashing (1 Hz) while button pressed: <i>Manual operation</i> not enabled or blocked
 <i>Group LED</i>		LED On: Group selected LED Off: Group not selected
 <i>Output button/LED</i>	Button without function	<p>Switch Actuator application: LED On: Relay contact closed LED Off: Relay contact open</p> <p>Shutter Actuator application: LED I On and LED II Off: Upper end position LED I Off and LED II On: Lower end position LED I Off and LED II Off: Intermediate position LED I flashing (1 Hz) and LED II Off: Up movement LED I Off and LED II flashing (1 Hz): Down movement LED I flashing (1 Hz) and LED II flashing (1 Hz): Shutter output pair blocked LED I flashing (5 Hz) and LED II flashing (5 Hz): Shutter output pair active (after the group is changed or after change to <i>KNX operation</i>)</p>

Tab. 55: Operating and display elements

3.13.4 Technical data

3.13.4.1 General technical data

Device	Dimensions	90 × 210 × 63.5 mm (H x W x D)
	Mounting width in space units	12 modules, 17.5 mm each
	Weight	0.72 kg
	Mounting position	Any
	Mounting variant	35 mm mounting rail
	Design	proM
	Degree of protection	IP 20
	Protection class	II
	Overvoltage category	III
	Pollution degree	2
Materials	Housing	Polycarbonate, Makrolon FR6002, halogen free
Material note	Fire classification	Flammability V-0
Electronics	Rated voltage, bus	30 V DC
	Voltage range, bus	21 ... 31 V DC
	Current consumption, bus	< 12 mA
	Maximum current, device	200 A
	Power loss, device	≤ 9 W
	Power loss, bus	≤ 0.25 W
	KNX safety extra low voltage	SELV
Connections	Connection type, KNX bus	Plug-in terminal
	Cable diameter, KNX bus	0.6 ... 0.8 mm, solid
	Connection type, load circuit	Screw terminal with universal head (PZ 1)
	Pitch	6.35 mm
	Tightening torque, screw terminals	0.5 ... 0.6 Nm
	Conductor cross-section, flexible	1 × (0.2 ... 4 mm ²) / 2 × (0.2 ... 2.5 mm ²)
	Conductor cross section, rigid	1 × (0.2 ... 6 mm ²) / 2 × (0.2 ... 4 mm ²)
	Conductor cross section with wire end ferrule without plastic sleeve	1 × (0.25 ... 2.5 mm ²)
	Conductor cross section with wire end ferrule with plastic sleeve	1 × (0.25 ... 4 mm ²)
	Conductor cross section with TWIN wire end ferrule	1 × (0.5 ... 2.5 mm ²)
Length, wire end ferrule contact pin	≥ 10 mm	
Certificates and declarations	Declaration of conformity CE	→ 2CDK505212D2701
Ambient conditions	Operation	-5 ... +45 °C
	Transport	-25 ... +70 °C
	Storage	-25 ... +55 °C
	Humidity	≤ 95 %
	Condensation allowed	No
	Atmospheric pressure	≥ 80 kPa (corresponds to air pressure at 2,000 m above sea level)

Tab. 56: General technical data

3.13.4.2 Outputs – relays 16 A







Rated values	Number of outputs	24 switch/12 shutter
	Rated voltage U_n	230 V AC
	Rated current I_n (per output)	16 A
	Rated frequency	50/60 Hz
	Relay type	Bi-stable
Switching currents	AC-1 operation ($\cos \varphi = 0.8$)	≤ 16 A
	AC-3 operation ($\cos \varphi = 0.45$)	≤ 6 A
	Switching current at 12 V AC	≥ 0.1 A
	Switching current at 24 V AC	≥ 0.1 A
	Switching current at 24 V DC (resistive load)	≤ 16 A
Service life	Mechanical service life	$\geq 10^6$ switching operations
	AC-1 operation ($\cos \varphi = 0.8$)	$\geq 10^5$ switching operations
	AC-3 operation ($\cos \varphi = 0.45$)	$\geq 6 \times 10^3$ switching operations
Switching operations	Switching operations per minute when one relay switches	≤ 120
	Switching operations per minute when all relays switch	≤ 5
Starting current	Starting current I_{peak} (150 μ s)	≤ 200 A
	Starting current I_{peak} (250 μ s)	≤ 160 A
	Starting current I_{peak} (600 μ s)	≤ 100 A

Tab. 57: Outputs – relays 16 A

Note

The starting current I_{peak} is the typical ballast load current that results during switching. Using the starting current I_{peak} , it is possible to calculate the maximum number of switchable ballasts at the Switch Actuator output → [Ballast calculation, Page 291](#).

3.13.4.2.1 Load table

Load type	Symbol	Max. load
Incandescent bulbs		1200 W
Fluorescent lamps uncompensated		800 W
Low-voltage halogen lamps inductive transformer		800 W
Low-voltage halogen lamps electronic transformer		1000 W
Low-voltage halogen lamps 230 V		1000 W
Mercury-vapor lamps uncompensated		1000 W
Mercury-vapor lamps parallel compensated		800 W
LED lamps		250 W
Rated motor power		1380 W

Tab. 66: Load table

3.13.4.3 Device type

Device type	Switch/Shutter Actuator	SAH/S 24.16.7.1
	Application	Switch/Shutter 24-fold 16 A / = current version number of the application
	Maximum number of Group Objects	610
	Maximum number of group addresses	1000
	Maximum number of assignments	1000

Tab. 58: Device type

i Note

Observe software information on the website → www.abb.com/knx.

i Note

The device may be protected with a BCU key in ETS. If a BCU key was assigned, the device cannot be read or programmed without it.

4 Function

4.1 Device functions

The devices possess mutually independent switching relays with which the following functions can be implemented:

- Switching primarily resistive loads in single- or multi-phase electrical networks (Switch Actuator outputs)
- Activation of AC shutter/blind drives (Shutter Actuator output pairs)

Switch outputs and shutter outputs can be mixed in the devices. On-site operation of the outputs is possible by manual operation. LEDs additionally indicate the Switch/Shutter status.



CAUTION

The outputs on the device are not interlocked mechanically. Connecting shutter/blind motors to Switch Actuator outputs will result in damage to the shutter/blind motor.

- ▶ Connect shutter/blind motors only to Shutter Actuator output pairs.

4.2 Software functions

4.2.1 Functional overview

	SAH/S 8.x.7.1	SAH/S 16.x.7.1	SAH/S 24.x.7.1
Type of outputs	Switch Actuator		Shutter Actuator
Manual operation	x		x
Blocking manual operation	x		x
Function Switch	x		x
Staircase lighting	x		
Staircase lighting advance warning	x		
Delay for switching on and off	x		
Flashing	x		
NO contact/NC contact	x		
Function Shutter			x
Blind			x
Shutter			x
Automatic sun protection			x
Reversing time			x
reference movement			x
Function Load shedding	x		
Function Energy			
Current measurement			
Power calculation			
Energy consumption			
Load monitoring			
Function Scene	x		x
Function Threshold	x		x
Function Logic	x		x
Forced operation/Block	x		x
Safety	x		x
Weather alarms			x
Special functions	x		x
Contact supervision			
Reaction on bus voltage failure/recovery	x		x
status message	x		x
i-bus® Tool	x		x

Tab. 59: Functional overview

Note

The interface to i-bus® Tool is available from the following software versions:

- Application from V1.2
- Firmware from V0.2.0

4.2.2 Function diagram Shutter Actuator

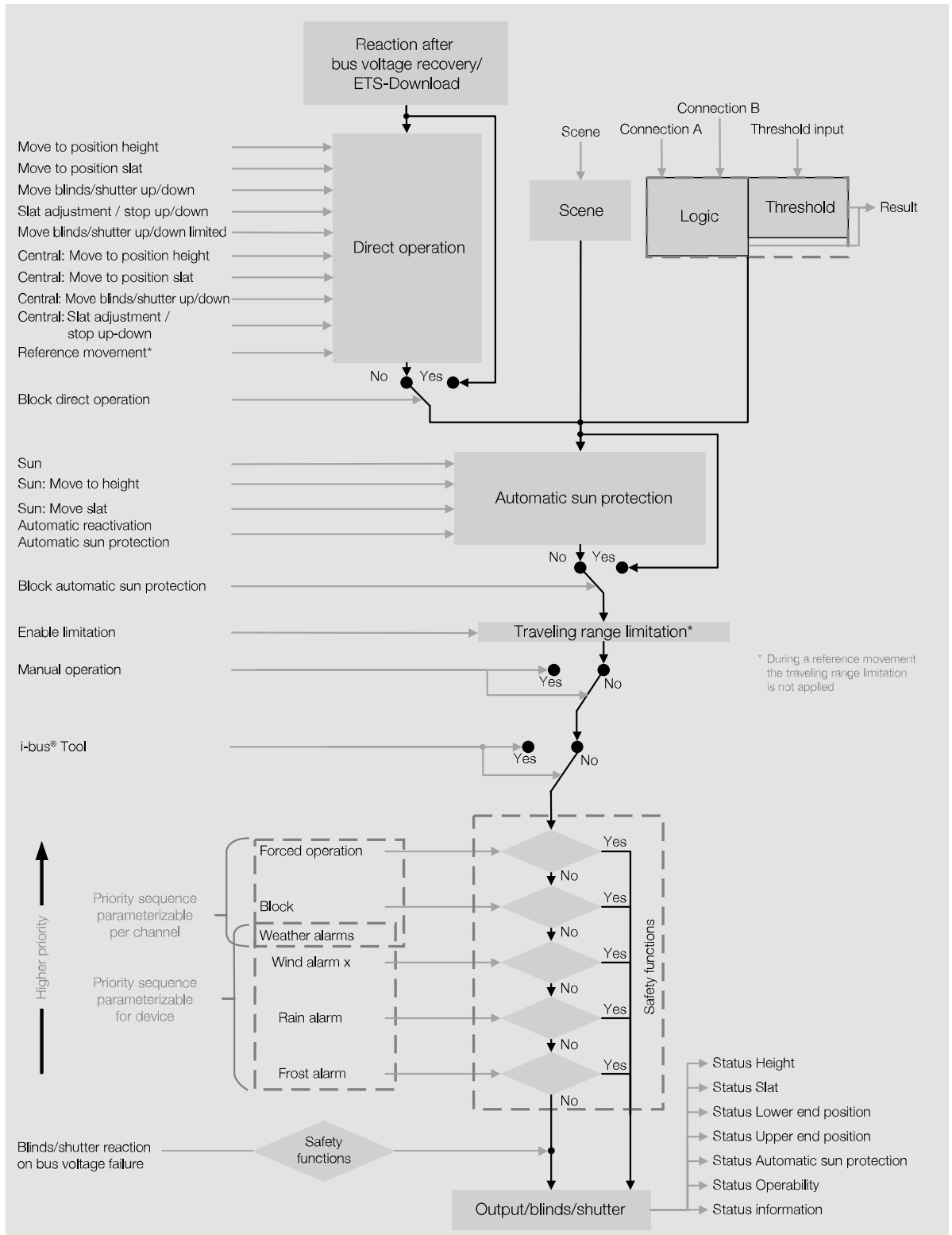

Fig. 28: Function diagram Shutter Actuator

Note

The interface to i-bus® Tool is available from the following software versions:

- Application from V1.2
- Firmware from V0.2.0

4.2.3 Function diagram Switch Actuator

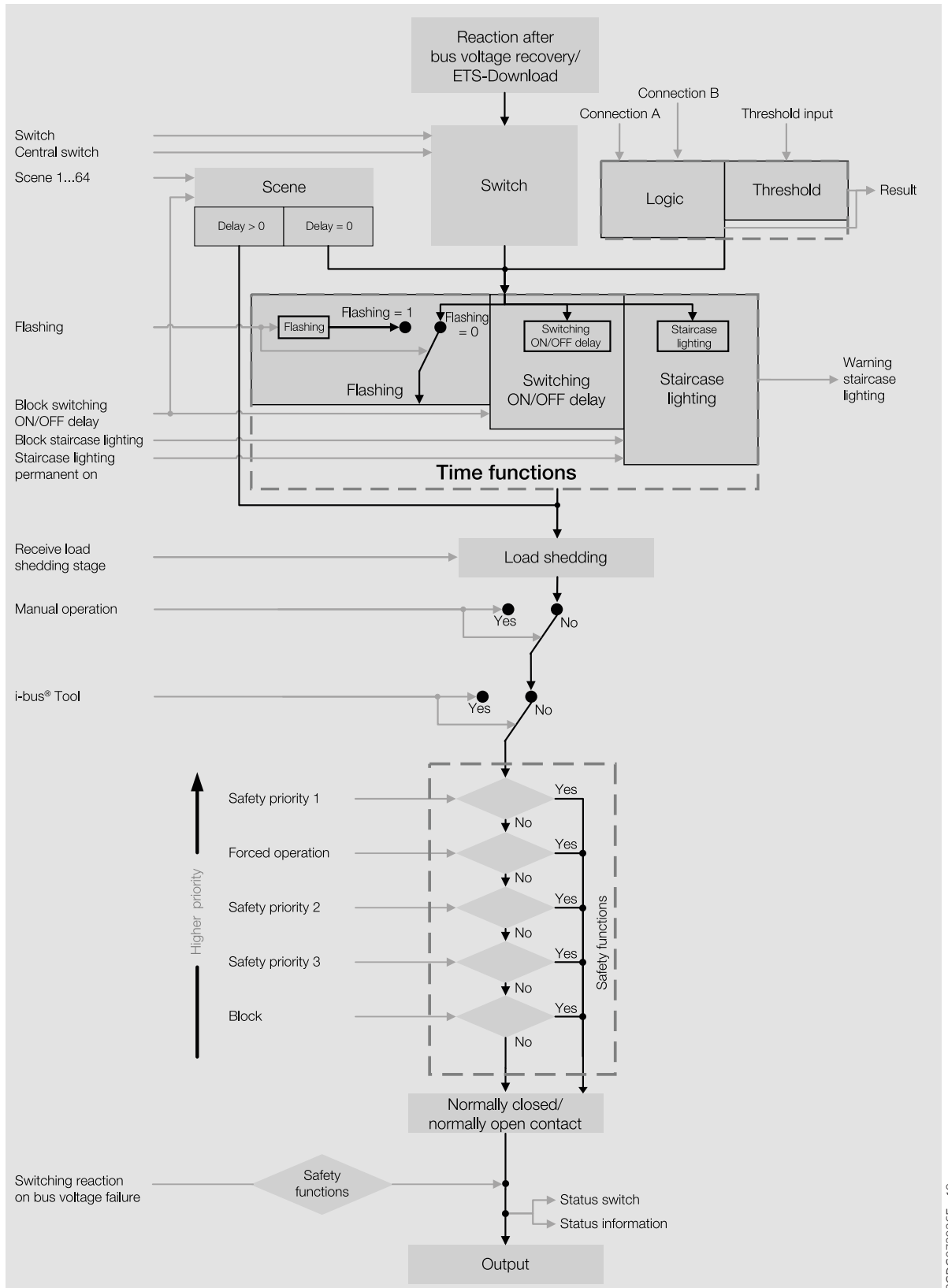

2CDC072026F-x19

Note

The interface to i-bus® Tool is available from the following software versions:

- Application from V1.2
- Firmware from V0.2.0

4.2.4 Safety functions

4.2.4.1 Safety functions of Shutter Actuator

4.2.4.1.1 Priority of safety functions

The safety functions *Wind alarm*, *Rain alarm*, *Frost alarm*, *Block* and *Forced operation* have priority over all other functions. If one of these safety functions is active, operation of the corresponding output is blocked.

In order to control the Blind/Shutter when several safety functions are active, the order of priority of safety functions can be defined in the parameter *Order of priority of weather alarm, block and forced operation*.

Example

The order of priority is used to specify that forced operation has priority over a wind alarm during window cleaning. If a wind alarm is received, the Blind/Shutter is not moved.

4.2.4.1.2 Wind alarm

This safety function is parameterized in the following parameter window:

- Parameter window *Safety/Weather alarms*

The safety function *Wind alarm* can be used to protect the Blind/Shutter on the shutter output in windy conditions. For this purpose, the device can receive alarm telegrams from up to three wind sensors via the Group Objects *Wind alarm x*.

The user can freely select which (if any) of the three wind alarms each output should react to. The Blind/Shutter position can be specified individually for each output for a wind alarm and for the cancellation of a wind alarm. If several wind alarms are assigned to an output, they will be linked by a logic OR.

The safety function *Wind alarm* and the corresponding Group Objects are enabled in the parameter *Enable Group Object "Wind alarm x"*. The wind alarm is active if

- A telegram with the value 1 is received on the Group Object *Wind alarm x*.
- A telegram is not received on the Group Object *Wind alarm x* within the time set in the parameter *Cyclical monitoring* → *Cyclical monitoring*, Page 293.

If a wind alarm occurs, the Blind/Shutter will be moved to the position set in the parameter *Blind/Shutter reaction on wind alarm* and operation will be blocked.

If a wind, rain or frost alarm is canceled, the Blind/Shutter will be moved to the position set in the parameter *Blind/Shutter reaction on cancellation of weather alarm, block and forced operation* and operation will be enabled.

The parameter *Order of priority for weather alarms* can be used to specify the order of priority of the weather alarms.

Note

If a weather alarm is active, Blind/Shutter control via other Group Objects, manual operation or i-bus® Tool is blocked. Travel range limits are ignored.

Higher-priority safety functions continue to run → [Function diagram Shutter Actuator, Page 86](#).

4.2.4.1.3**Rain alarm**

This safety function is parameterized in the following parameter window:

- Parameter window [Safety/Weather alarms](#)

The safety function *Rain alarm* can be used to protect the Blind/Shutter on the shutter output in rainy conditions. For this purpose, the device can receive an alarm telegram from a corresponding sensor via the Group Object [Rain alarm](#).

The user can freely select whether each output should react to a rain alarm. The Blind/Shutter position can be specified individually for each output for a rain alarm and for the cancellation of a rain alarm.

The safety function *Rain alarm* and the corresponding Group Object are enabled in the parameter [Enable Group Object "Rain alarm"](#). The rain alarm is active if

- A telegram with the value 1 is received on the Group Object [Rain alarm](#).
- A telegram is not received on the Group Object [Rain alarm](#) within the time set in the parameter [Cyclical monitoring](#) → [Cyclical monitoring, Page 293](#).

If a rain alarm occurs, the Blind/Shutter will be moved to the position set in the parameter [Blind/Shutter reaction on rain alarm](#) and operation will be blocked.

If a wind, rain or frost alarm is canceled, the Blind/Shutter will be moved to the position set in the parameter [Blind/Shutter reaction on cancellation of weather alarm, block and forced operation](#) and operation will be enabled.

The parameter [Order of priority for weather alarms](#) can be used to specify the order of priority of the weather alarms.

Note

If a weather alarm is active, Blind/Shutter control via other Group Objects, manual operation or i-bus® Tool is blocked. Travel range limits are ignored.

Higher-priority safety functions continue to run → [Function diagram Shutter Actuator, Page 86](#).

4.2.4.1.4**Frost alarm****CAUTION**

The Blind/Shutter can freeze in place at temperatures below 0 °C. Attempting to move the frozen Blind/Shutter can damage the drive.

- ▶ Use the function *Frost alarm*.

This safety function is parameterized in the following parameter window:

- Parameter window [Safety/Weather alarms](#)

The safety function *Frost alarm* can be used to protect the Blind/Shutter on the shutter output in frosty conditions. For this purpose, the device can receive an alarm telegram from a corresponding sensor via the Group Object [Frost alarm](#).

The user can freely select whether each output should react to a frost alarm. The Blind/Shutter position can be specified individually for each output for a frost alarm and for the cancellation of a frost alarm.

The safety function *Frost alarm* and the corresponding Group Object are enabled in the parameter *Enable Group Object "Frost alarm"*. The frost alarm is active if

- A telegram with the value 1 is received on the Group Object *Frost alarm*.
- A telegram is not received on the Group Object *Frost alarm* within the time set in the parameter *Cyclical monitoring* → [Cyclical monitoring, Page 293](#).

If a frost alarm occurs, the Blind/Shutter will be moved to the position set in the parameter *Blind/Shutter reaction on frost alarm* and operation will be blocked.

If a wind, rain or frost alarm is canceled, the Blind/Shutter will be moved to the position set in the parameter *Blind/Shutter reaction on cancellation of weather alarm, block and forced operation* and operation will be enabled.

The parameter *Order of priority for weather alarms* can be used to specify the order of priority of the weather alarms.

Note

If a weather alarm is active, Blind/Shutter control via other Group Objects, manual operation or i-bus® Tool is blocked. Travel range limits are ignored. Higher-priority safety functions continue to run → [Function diagram Shutter Actuator, Page 86](#).

4.2.4.1.5

Block

This safety function is parameterized in the following parameter window:

- Parameter window [Safety/Weather alarms](#)

The safety function *Block* can be used to move the Blind/Shutter to a position specified in the parameter *Block* via the Group Object *Blind/Shutter reaction on block* and block operation.

If the block is canceled, the Blind/Shutter will be moved to the position defined in the parameter *Blind/Shutter reaction on cancellation of weather alarm, block and forced operation* and operation will be enabled.

Example

The safety function *Block* can be used to monitor a terrace door given appropriate parameterization. If the terrace door is opened, the Blind/Shutter will be moved to the upper end position and blocked in this position.

Note

If the safety function is active, the operation of the output via Group Objects, manual operation and i-bus® Tool is blocked. Higher-priority safety functions continue to run.
→ [Function diagram Shutter Actuator, Page 86](#)
→ [Function diagram Switch Actuator, Page 87](#)

4.2.4.1.6

forced operation

This safety function is parameterized in the following parameter window:

- Parameter window [Safety/Weather alarms](#)

The safety function *Forced operation* can be used to set the device outputs to a defined state and block them.

A state that is set if forced operation is activated can be parameterized with 1-bit forced operation. It can additionally be defined whether activation is to take place via the value 1 or 0.

With 2-bit forced operation, two states are specified that are set if forced operation is activated. Forced operation is activated/deactivated with the first bit. The defined state is set with the second bit.

Bit 1	Bit 0	State of forced operation
0	0	Forced operation inactive
0	1	Forced operation inactive
1	0	Forced operation active, state Off
1	1	Forced operation active, state On

Tab. 60: Coding of 2-bit forced operation

The safety function *Forced operation* is activated in the parameter *Forced operation (1 bit / 2 bit) [Shutter Actuator]*.

Note

Travel range limits are not taken into account with forced operation.

The positions of the Blind/Shutter and the slats during forced operation are specified in the following parameters:

- *Position height (0 % = top; 100 % = bottom)*
- *Position slat (0 % = open; 100 % = closed)*

The position of the Blind/Shutter if forced operation is canceled is specified in the parameter *Blind/Shutter reaction on cancellation of weather alarm, block and forced operation*.

Example

The safety function *Forced operation* can be used to move the Blind/Shutter to the upper end position and to block operation so as not to endanger the cleaning personnel while cleaning the windows.

Note

If the safety function is active, the operation of the output via Group Objects, manual operation and i-bus® Tool is blocked.

Higher-priority safety functions continue to run.

→ [Function diagram Shutter Actuator, Page 86](#)

→ [Function diagram Switch Actuator, Page 87](#)

4.2.4.2 Switch Actuator safety functions

4.2.4.2.1 Priority of safety functions

The safety functions *Safety priority x*, *Block* and *Forced operation* have priority over every other function. If one of these safety functions is active, operation of the corresponding output is blocked.

The order of priority of the safety functions cannot be changed, → [Priorities for Switch Actuator, Page 281](#).

4.2.4.2.2 Safety priority

This safety function is parameterized in the following parameter window:

- Parameter window [Safety](#)

The safety function *Safety priority* can be used to protect electrical loads on the switching output or to switch them in accordance with an installation situation.

Three different safety priorities are available for the Switch Actuator outputs. The user can freely select which (if any) of the safety priorities each output should react to. The position of the relay contact can be specified individually for each output for a safety priority and for the cancellation of a safety priority.

Each safety priority has its own Group Object. The Group Object and the corresponding safety function are enabled in the parameter *Enable Group Object "Safety priority x"*. Safety priority x is active if:

- A telegram with the value 1 is received on the Group Object *Safety priority x*.
- A telegram is not received on the Group Object *Safety priority x* within the time set in the parameter *Cyclical monitoring* → [Cyclical monitoring, Page 293](#).

If the safety priority is active, the relay adopts the contact position set in the parameter *Switching reaction on safety priority x* and operation is blocked.

If the corresponding safety priority is canceled, the relay adopts the contact position set in the parameter *Switching reaction on cancellation of block, forced operation and safety priority* and operation is enabled.

Note

If a safety priority is active, the operation of the output via Group Objects, manual operation and i-bus® Tool is blocked.
Higher-priority safety functions continue to run → [Function diagram Switch Actuator, Page 87](#).

4.2.4.2.3

Block

This safety function is parameterized in the following parameter window:

- Parameter window [Safety](#)

The safety function *Block* can be used to block the output via the Group Object *Block*. The relay adopts the contact position specified in the parameter *Switching reaction on block* and operation is blocked.

If the block is canceled, the relay adopts the contact position set in the parameter *Switching reaction on cancellation of block, forced operation and safety priority* and operation is enabled.

Note

If the safety function is active, the operation of the output via Group Objects, manual operation and i-bus® Tool is blocked.

Higher-priority safety functions continue to run.

→ [Function diagram Shutter Actuator, Page 86](#)

→ [Function diagram Switch Actuator, Page 87](#)

4.2.4.2.4

forced operation

This safety function is parameterized in the following parameter window:

- Parameter window [Safety](#)

The safety function *Forced operation* can be used to set the device outputs to a defined state and block them.

A state that is set if forced operation is activated can be parameterized with 1-bit forced operation. It can additionally be defined whether activation is to take place via the value 1 or 0.

With 2-bit forced operation, two states are specified that are set if forced operation is activated. Forced operation is activated/deactivated with the first bit. The defined state is set with the second bit.

Bit 1	Bit 0	State of forced operation
0	0	Forced operation inactive
0	1	Forced operation inactive
1	0	Forced operation active, state Off
1	1	Forced operation active, state On

Tab. 61: Coding of 2-bit forced operation

The safety function *Forced operation* is activated in the parameter *Forced operation (1 bit / 2 bit) [Switch Actuator]*.

The position of the relay contact during forced operation is specified in the parameter *Switching reaction on forced operation*.

The position of the relay contact if forced operation is canceled is specified in the parameter *Switching reaction on cancellation of block, forced operation and safety priority*.

Example

The safety function *Forced operation* can be used to ensure that all lights are switched on and secured against switching off during a fire alarm.

i Note

If the safety function is active, the operation of the output via Group Objects, manual operation and i-bus® Tool is blocked.

Higher-priority safety functions continue to run.

→ [Function diagram Shutter Actuator, Page 86](#)

→ [Function diagram Switch Actuator, Page 87](#)

4.2.5 Function Logic

This function is parameterized in the following parameter window:

- Parameter window *Logic/Threshold* \ Parameter window *Logic/Threshold x*

The functions *Logic* and *Threshold* can be used independent of other functions.

The function *Logic* can be used to influence the reaction of an output by means of the following logic functions:

- AND
- OR
- Exclusive OR
- GATE
- 1 bit Inverter

Two input Group Objects (*Connection A*, *Connection B*) and one result Group Object (*Status Result [Logic]*) are available for the AND, OR, exclusive OR and GATE logic functions.

An input Group Object (*Connection A*) and a result Group Object (*Status Result [Logic]*) are available for the 1-bit inverter.

The result can be linked internally to any output in the parameter *Output reacts to* or output on the Group Object *Status Result [Logic]*.

If the result is linked internally to an output, the result has the same priority as Scene recalls, switching or shutter commands → [Function diagram Shutter Actuator, Page 86](#), → [Function diagram Switch Actuator, Page 87](#).

The send behavior of the Group Object *Status Result [Logic]* is defined in the parameter *Send value of Group Object "Status Result"*. Internally in the device, the result is updated when a value is received on one of the two input Group Objects.

The result is dependent on the logic function selected and the values in the corresponding input Group Objects. Refer to the table below for information about the reaction of the logic functions:

Logic function	Connection A	Connection B	Result	Explanation
AND	0	0	0	The result is 1 if both input values are 1.
	0	1	0	
	1	0	0	
	1	1	1	
OR	0	0	0	The result is 1 if at least one of the input values is 1.
	0	1	1	
	1	0	1	
	1	1	1	
Exclusive OR	0	0	0	The result is 1 if the input values differ.
	0	1	1	
	1	0	1	
	1	1	0	
GATE	Blocked	0	-	The input value (Connection B) is processed only if the GATE is open. The value is ignored if the GATE is blocked.
	Open	0	0	
	Blocked	1	-	
	Open	1	1	
1 bit Inverter	0	-	1	The input value (Connection A) is inverted.
	1	-	0	

Tab. 62: Results of the logic functions

The result is recalculated when a value is received on one of the two input Group Objects *Connection A* or *Connection B*.

4.2.6 Function Threshold

This function is parameterized in the following parameter window:

- Parameter window *Logic/Threshold* \ Parameter window *Logic/Threshold x*

The functions *Logic* and *Threshold* can be used independent of other functions.

The function *Threshold* is used to compare the value received on the threshold input with the thresholds set in the parameters *Upper threshold* and *Lower threshold*.

A minimum duration for undershooting and overshooting the thresholds can be defined in the following parameters:

- *Min. duration of the overshoot*
- *Min. duration of the undershoot*
- *Minimum dwell time between the thresholds*

One of the following Group Objects is used as the threshold input, depending on the setting in the parameter *Data point type of Group Object "Threshold input"*:

- *Threshold input* (DPT 13.010)
- *Threshold input* (DPT 13.013)
- *Threshold input* (DPT 14.019)
- *Threshold input* (DPT 14.056)
- *Threshold input* (DPT 5.001)
- *Threshold input* (DPT 5.010)
- *Threshold input* (DPT 7.001)
- *Threshold input* (DPT 9.001)
- *Threshold input* (DPT 9.004)
- *Threshold input* (DPT 9.021)
- *Threshold input* (DPT 9.024)

A result can be defined in the following parameters depending on whether the value on the threshold input is above or below the thresholds:

- *Result if upper threshold is exceeded*
- *Result if lower threshold is dropped below*

The result can be linked internally to any output in the parameter *Output reacts to* or output on the Group Object *Status Result [Threshold]*.

If the result is linked internally to an output, the result has the same priority as Scene recalls, switching or shutter commands → [Function diagram Shutter Actuator, Page 86](#), → [Function diagram Switch Actuator, Page 87](#).

The parameter *Monitor range between thresholds* can be used to define whether the range between the upper and lower thresholds is monitored and an evaluation is output on the Group Object *Status Input value between thresholds*.

The send behavior of the Group Objects *Status Result [Threshold]* and *Status Input value between thresholds* is defined in the parameter *Send values of Group Objects "Status Result" and "Status Input value between thresholds"*. Internally in the device, the result is updated when a value is received on the threshold input.

The thresholds set in ETS can be changed via the bus (ABB i-bus® KNX). The setting is made in the following parameters:

- [Change thresholds via Group Objects](#)
- [Change thresholds via i-bus® Tool](#)

The modified thresholds are received on the following Group Objects via the bus (ABB i-bus® KNX), depending on the setting in the parameter *Data point type of Group Object "Threshold input"*:

- [Change upper threshold](#) (DPT 13.010)
[Change lower threshold](#) (DPT 13.010)
- [Change upper threshold](#) (DPT 13.013)
[Change lower threshold](#) (DPT 13.013)
- [Change upper threshold](#) (DPT 14.019)
[Change lower threshold](#) (DPT 14.019)
- [Change upper threshold](#) (DPT 14.056)
[Change upper threshold](#) (DPT 14.056)
- [Change upper threshold](#) (DPT 5.001)
[Change lower threshold](#) (DPT 5.001)
- [Change upper threshold](#) (DPT 5.010)
[Change lower threshold](#) (DPT 5.010)
- [Change upper threshold](#) (DPT 7.001)
[Change lower threshold](#) (DPT 7.001)
- [Change upper threshold](#) (DPT 9.001)
[Change lower threshold](#) (DPT 9.001)
- [Change upper threshold](#) (DPT 9.004)
[Change lower threshold](#) (DPT 9.004)
- [Change upper threshold](#) (DPT 9.021)
[Change lower threshold](#) (DPT 9.021)
- [Change upper threshold](#) (DPT 9.024)
[Change lower threshold](#) (DPT 9.024)

In the parameter *Overwrite thresholds on download* it is defined whether the thresholds changed via the bus (ABB i-bus® KNX) are overwritten with the thresholds set in ETS during an application download.

4.2.7

Function Load shedding

i Note

This function is only available for Switch Actuator outputs.

This function is parameterized in the following parameter window:

- Parameter window [Switch Actuator X](#) \ Parameter window [Load shedding](#)

With the function *Load shedding*, a load control master (e.g. Energy Analyzer QA/S, Energy Actuator SE/S) can manage an electrical installation energy efficiently. If a defined load limit is exceeded, the load control master sends switching commands in the form of load shedding stages on the bus (ABB i-bus® KNX). The slave devices receive the load shedding stages and react as per the parameterization.

The load shedding stages can be defined individually for each channel in the slave devices.

The functionality is explained in the following example based on a QA/S as the master:

Note

The QA/S (master) processes eight load shedding stages in this example. The number of load shedding stages must be matched between master and slave.

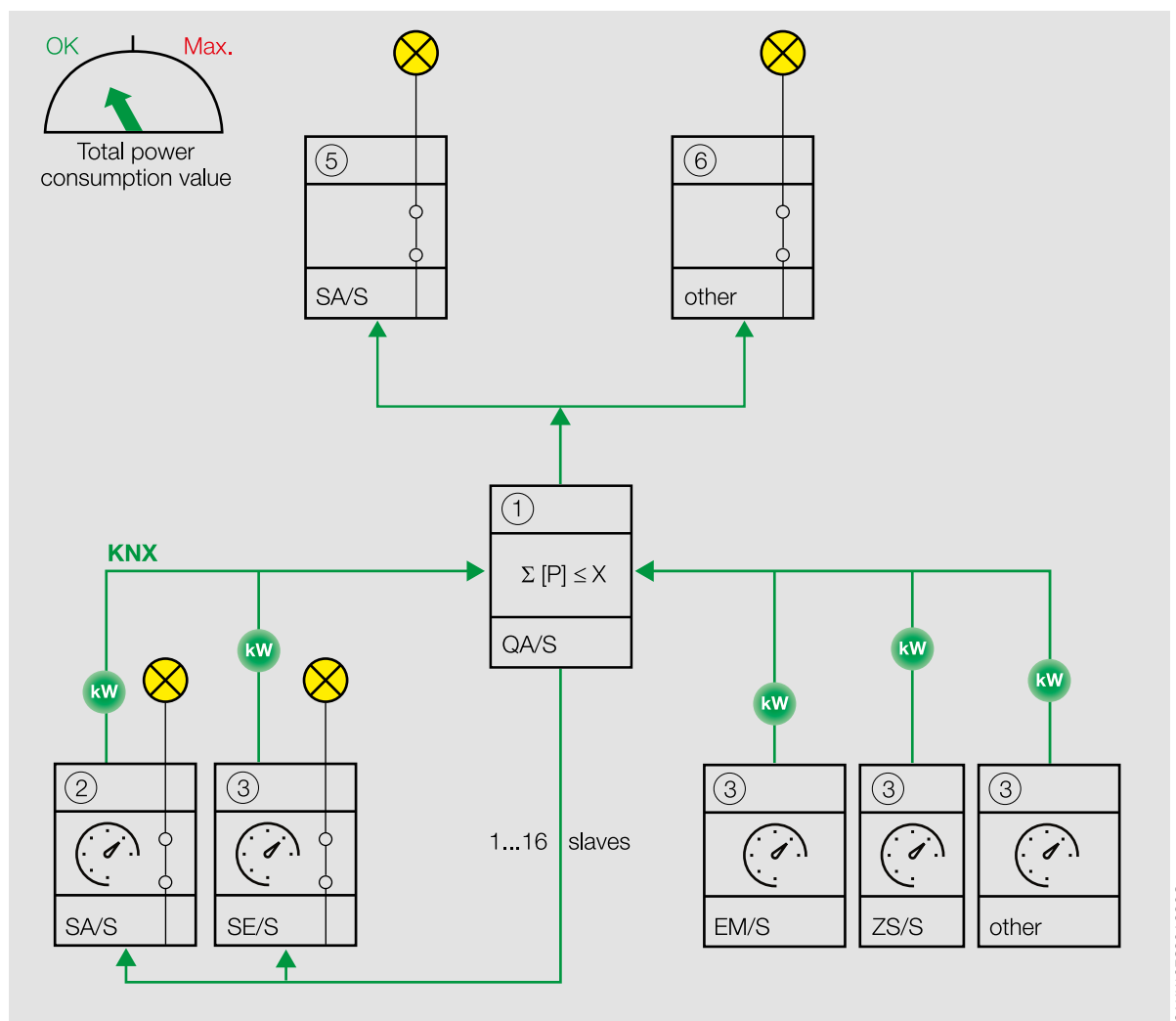

Fig. 29: Master receives power values

The QA/S (master) (1) receives power values from up to 16 slaves (e.g. SA/S x.16.6.2 (2) or energy meters such as SE/S, EM/S, ZS/S (3)). Devices (5) (6) that do not send any direct energy consumption values can also be integrated into the function *Load shedding* via an energy meter (e.g. ZS/S (3)).

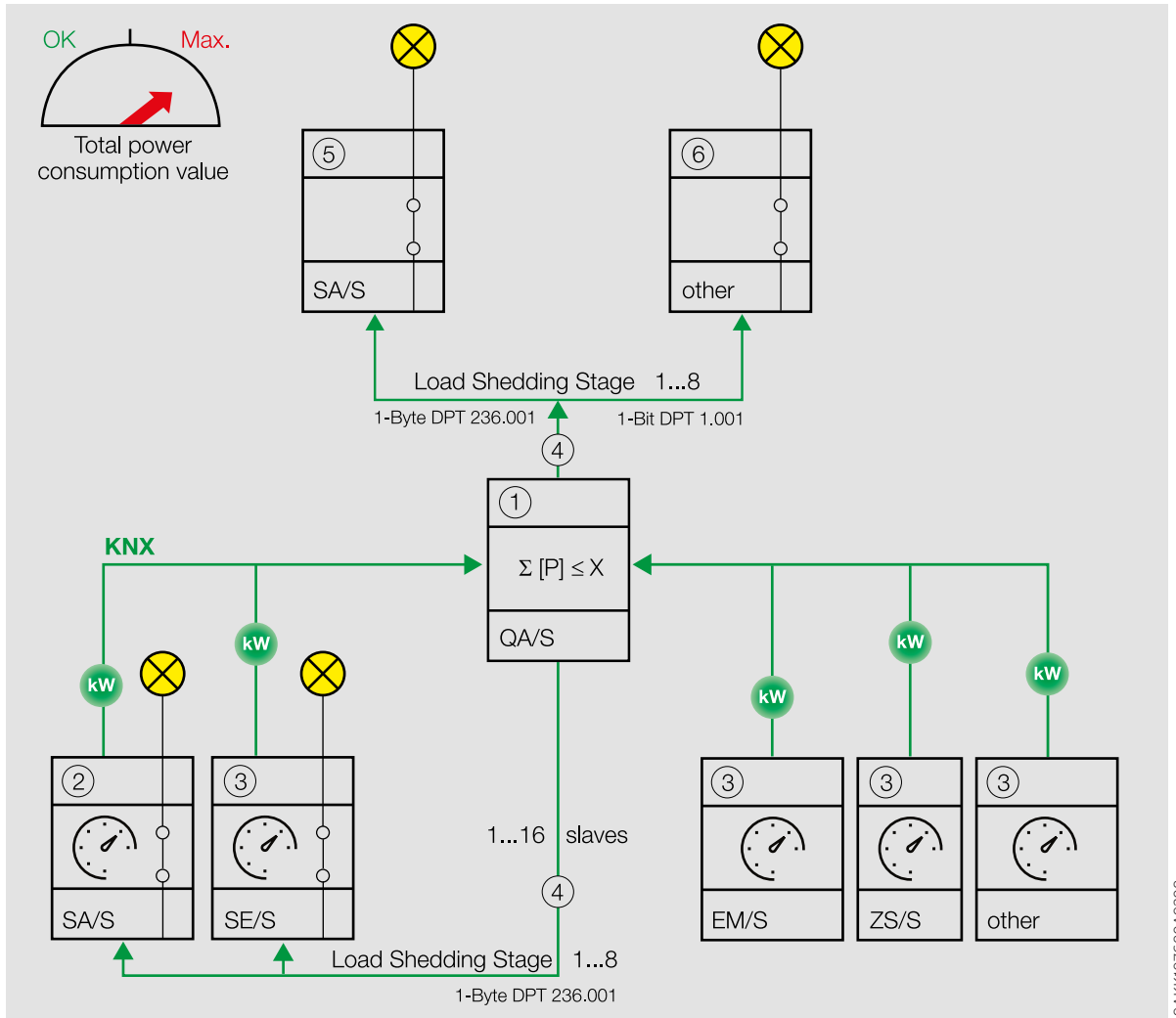

Fig. 30: Master adds together power values received

The master adds together the power values received and calculates the total power consumption. If the total power consumption exceeds the load limit defined, the master sends load shedding stages (4) on the bus (ABB i-bus® KNX).

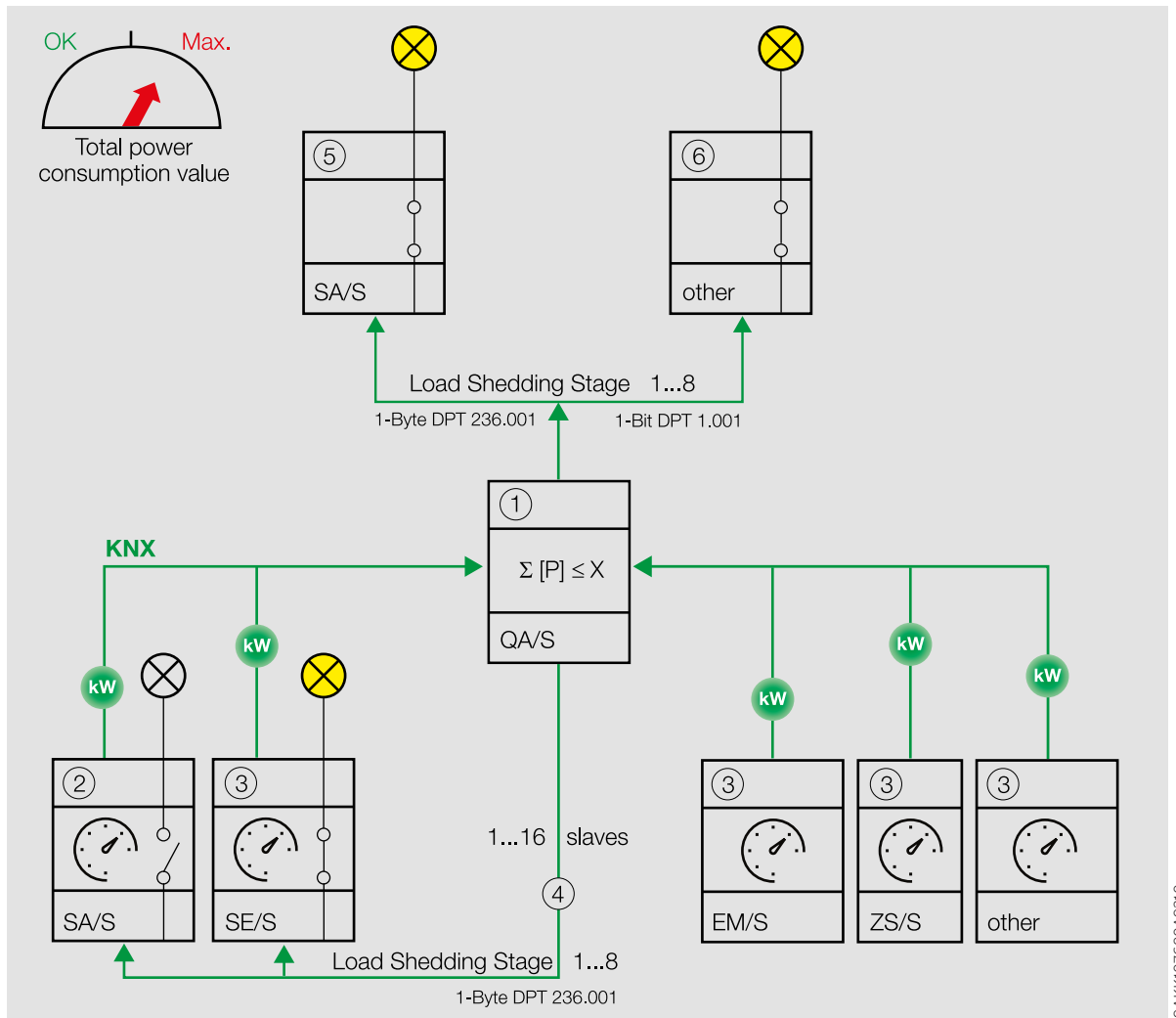

Fig. 31: Slaves receive load shedding stages

The slaves receive the load shedding stages and switch all channels that are assigned to this load shedding stage, corresponding to the reaction defined in the parameter *Switching reaction on active load shedding stage*.

Note

Integration of other devices into the load shedding → corresponding product manuals.

Note

- All ABB Switch Actuators (5) (Combi, Standard and Professional) contain the function *Load shedding*, including the Group Object *Receive load shedding stage* (DPT 236.001).
- Other devices (6) without the Group Object *Receive load shedding stage* (DPT 236.001) can be integrated into the function *Load shedding* using the Group Objects "Send load shedding stage x" (DPT 1.001) of the QA/S Energy Analyzer.

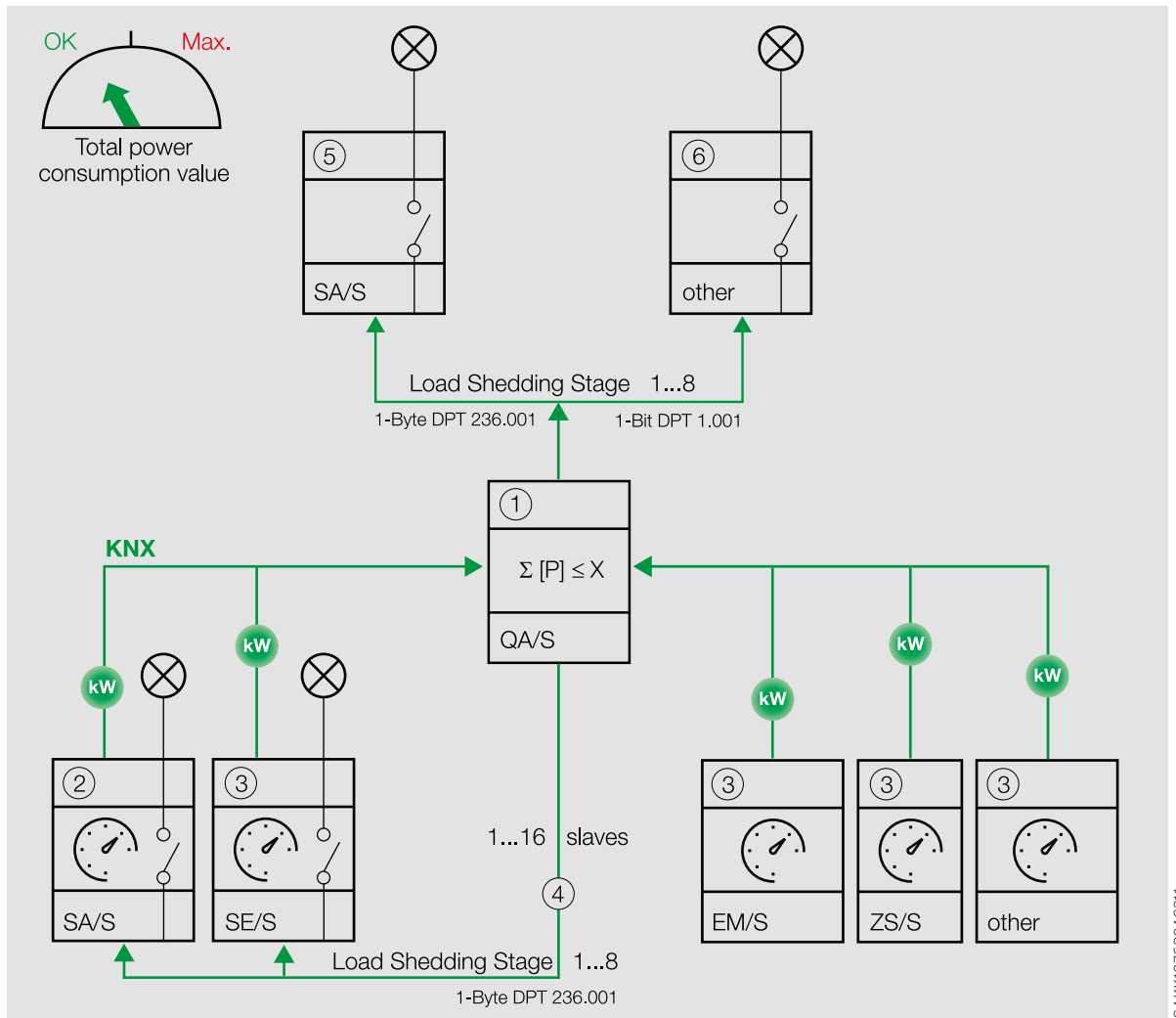

Fig. 32: Master increases load shedding stage

The master increases the load shedding stage until the total power consumption drops below the load limit.

Note

Integration of other devices into the load shedding → corresponding product manuals.

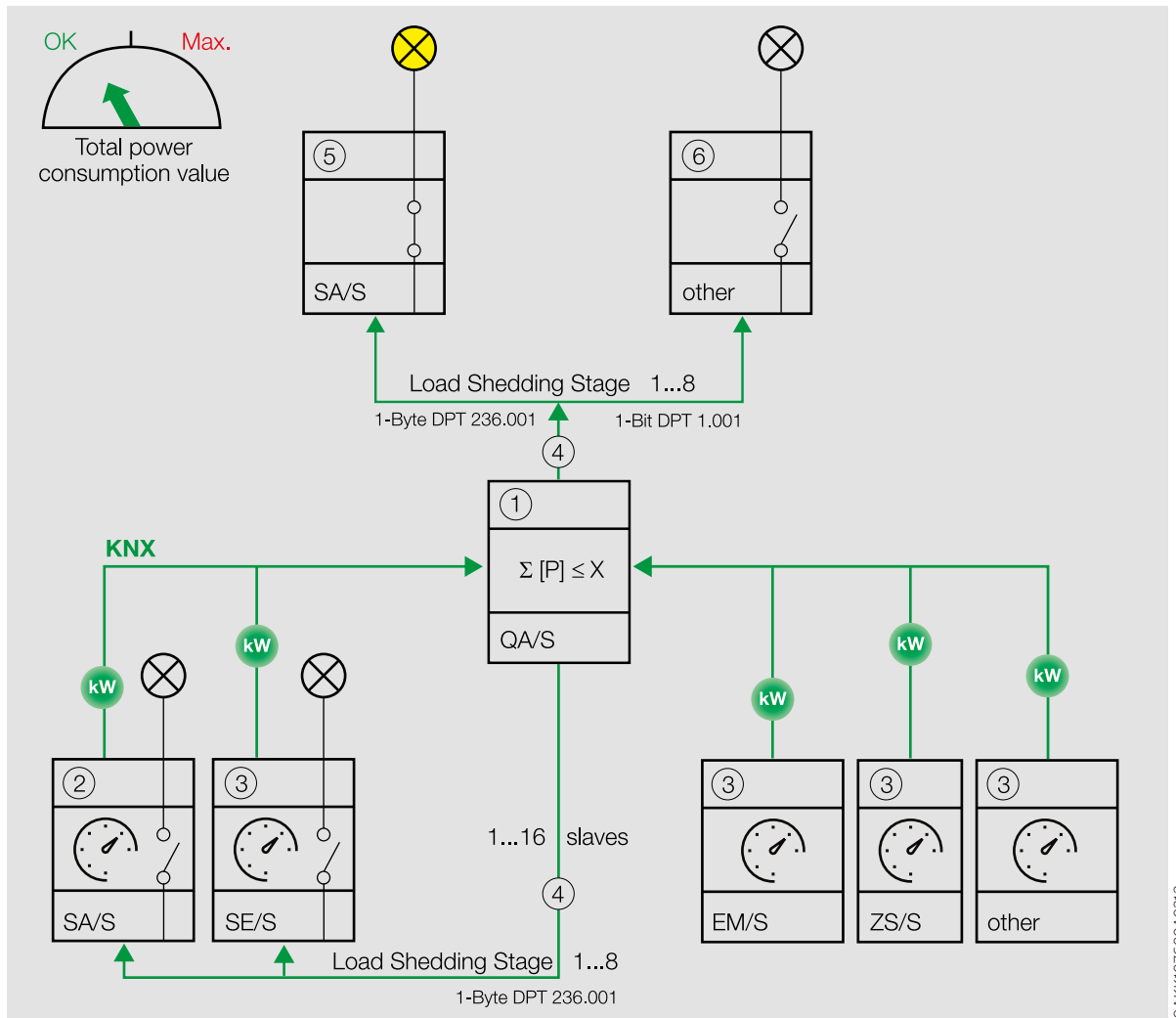

Fig. 33: Master decreases load shedding stage

Once the total power consumption has dropped below the load limit, the master (1) decreases the load shedding stage and sends this information via the bus (ABB i-bus® KNX) to the slaves. The channels react corresponding to the setting in the parameter *Switching reaction on revoke of load shedding stage*.

The load shedding stage for the channel is defined in the parameter *Load shedding stage*.

The load shedding stage set in ETS can be changed via the bus (ABB i-bus® KNX). The setting is made in the following parameters:

- *Change load shedding stage via Group Object*
- *Change load shedding stage via i-bus® Tool*

The modified load shedding stage is received on the Group Object *Set load shedding stage* via the bus (ABB i-bus® KNX).

In the parameter *Overwrite load shedding stage at download* it is defined whether the load shedding stage changed via the bus (ABB i-bus® KNX) is overwritten with the load shedding stage set in ETS during an application download.

4.2.8 Function Automatic sun protection

This function is parameterized in the following parameter window:

- Parameter window *Automatic sun protection*

The function *Automatic sun protection* can be used to implement fully automatic room shading solutions depending on the sunshine. Together with other KNX components (in particular with the Shutter Control Unit JSB/S), the device can be used to establish easy-to-use Automatic sun protection control.

Blind/shutter and slat positions can be specified in the parameters for Sun = 1 and Sun = 0. Alternatively the positions for Sun = 1 and Sun = 0 can also be received via separate 1-byte Group Objects.

The function *Automatic sun protection* can be enabled individually for each output pair → parameter *Enable function Automatic sun protection*.

Information about sunshine (Sun = 1 and Sun = 0) can be determined via an external sensor and received via the Group Object *Sun*.

For more information, see:

→ [Activation/deactivation of Automatic sun protection, Page 101](#)

→ [Blocking Automatic sun protection, Page 101](#)

→ [Positioning for sunshine \(Sun = 1 and Sun = 0\), Page 102](#)

→ [Direct operation, Page 102](#)

Note

A reference movement interrupts the function *Automatic sun protection*. Incoming Automatic sun protection telegrams are executed after the reference movement is completed.

4.2.8.1 Activation/deactivation of Automatic sun protection

The function *Automatic sun protection* can be activated or deactivated using the Group Object *Activate/Deactivate Automatic sun protection*.

If the function *Automatic sun protection* is deactivated, the output does not react to incoming telegrams on the Automatic sun protection Group Objects. After deactivation of the function *Automatic sun protection*, the Blind/Shutter remains in its current position and can be controlled via the direct Group Objects. Movements started by Automatic sun protection telegrams are completed after deactivation of the function *Automatic sun protection*.

The parameter *Deactivation of Automatic sun protection* can be used to set how the function *Automatic sun protection* is deactivated.

The parameter *Automatic reactivation of Automatic sun protection* is used to set whether the function *Automatic sun protection* is reactivated automatically after an adjustable time if it was deactivated due to the receipt of a direct command.

4.2.8.2 Blocking Automatic sun protection

The function *Automatic sun protection* can be blocked or enabled using the Group Object *Block Automatic sun protection*.

If the function *Automatic sun protection* is blocked, activation via the Group Object *Activate/Deactivate Automatic sun protection* is not possible and the output pair can be activated only via direct Group Objects.

4.2.8.3 Positioning for sunshine (Sun = 1 and Sun = 0)

The Blind/Shutter and Slat positions when the sun is shining (Sun = 1) can be specified in the parameter [Reaction on sun = 1 \(sun\)](#).

The Blind/Shutter and Slat positions when the sun is no longer shining (Sun = 0) can be specified in the parameter [Reaction on sun = 0 \(no sun\)](#).

Alternatively, the Blind/Shutter and slat position can also be controlled directly:

- Via Group Object [Sun: Move to height](#):
If Automatic sun protection is active, the Blind/Shutter is moved according to the value received. If Automatic sun protection is deactivated, telegrams on this Group Object are ignored.
After reaching the target position, the slats are set to the same position as before the movement. If a telegram is received on the Group Object [Sun: Move slat](#) during the movement, after the target position is reached the slats will be set according to the value received.
- Via Group Object [Sun: Move slat](#):
If Automatic sun protection is active, the slats will be positioned according to the value received. If Automatic sun protection is deactivated, telegrams on this Group Object are ignored.

The reaction to incoming telegrams can be delayed using the parameters [Delay for sun = 1](#) and [Delay for sun = 0](#) to prevent frequent position changes due to the weather.

4.2.8.4 Direct operation

Direct operation is on-site operation using local buttons. In direct operation, direct commands are sent to the following direct Group Objects:

- [Move Blind/Shutter Up/Down](#)
- [Slat adjustment / Stop Up/Down](#)
- [Move to position height](#)
- [Move to position slat](#)
- [Scene 1 ... 64](#)
- [Move Blind/Shutter Up/Down](#)
- [Stop Up/Down](#)
- [Slat adjustment / Stop Up/Down](#)
- [Move to position height](#)
- [Move to position slat](#)
- [Scene 1 ... 64](#)

The change to direct operation can be blocked via the Group Object [Block direct operation](#). If direct operation is blocked, the output pair does not react to incoming telegrams on the direct Group Objects.

i Note

The operability via direct commands is not enabled in the following cases:

- One of the safety functions is active → [Safety functions of Shutter Actuator, Page 88](#)
- Automatic sun protection is active and can only be deactivated via the Group Object [Activate/Deactivate Automatic sun protection](#)
- Automatic sun protection is active and direct operation is blocked via the Group Object [Block direct operation](#)
- The device is in the *Manual operation* operating mode

4.2.9 Function Scenes

This function is parameterized in the following parameter window:

- Parameter window [Shutter Actuator X+Y](#) \ Parameter window [Scene assignments \[Shutter Actuator\]](#)
- Parameter window [Switch Actuator X](#) \ Parameter window [Scene assignments \[Switch Actuator\]](#)

The function *Scenes* can be used to create, to enable, to assign Scenes to the output and to incorporate additional KNX devices in a Scene. It is a prerequisite that all the devices incorporated are parameterized with the same Scene number and recall is via the same group address.

The following parameters can be used to create, enable and assign to the output up to 16 Scenes:

- [Enable Scene assignment x \[Shutter Actuator\]](#)
- [Enable Scene assignment x \[Switch Actuator\]](#)

An individual number (1 ... 64) is assigned for each Scene in the parameter [Scene number](#).

The reaction of the Blind/Shutter and the slats during Scene recall is specified in the following parameters:

- [Position height \(0 % = top; 100 % = bottom\)](#)
- [Position slat \(0 % = open; 100 % = closed\)](#)

The reaction of the output during Scene recall is defined in the parameter [Reaction on Scene recall](#).

The parameter [Delay](#) is used to define the delay with which the Scene is run after Scene recall.

i Note

If a delay is used for Scene recall (→ parameter [Delay](#)), the output does not react to the functions *Staircase lighting* and *Delay for switching on and off* → [Function diagram Switch Actuator, Page 87](#).

Scene recall

A Scene is recalled via the following Group Objects:

- [Scene 1 ... 64](#)
A Scene number is received via this central Group Object. All outputs and KNX devices incorporated execute the Scenes assigned with the corresponding Scene number. Depending on the telegram value, the current positions of the relay contacts for all outputs and KNX devices integrated can be saved in the Scene. In this way, the contact position for a Scene number can be overwritten.
- [Scene 1 ... 64 \(Shutter Actuator\)](#)
[Scene 1 ... 64 \(Switch Actuator\)](#)
A Scene number is received via these Group Objects. The output pair executes all Scenes assigned with the corresponding Scene number. Depending on the telegram value, the current position of the relay contact can be saved in the Scene. In this way, the contact position for a Scene number can be overwritten.
- [Recall Scene assignment x \(Shutter Actuator\)](#)
[Recall Scene assignment x \(Switch Actuator\)](#)
The Scene assignment x (x = 1 ... 4) for the output pair is recalled via these 1-bit Group Objects and the corresponding Scene number executed. This direct Scene recall is possible only for Scene assignments 1 ... 4.

4.2.9.1

Structure of 1-byte Scene telegram

A 1-byte Scene telegram contains the Scene number (1 ... 64) and information about whether to recall or save the Scene.

Telegram value:

- 0 ... 63 = Recall Scene x (x = 1 ... 64)
- 128 ... 191 = Save Scene x (x = 1 ... 64)

More information: → [Table of values, Group Object "Scene 1 ... 64", Page 299](#).

4.2.10 Time functions

Three time functions are available for each output. The parameter *Enable function Time* can be used to assign one of the following time functions to each output:

- → [Function Staircase lighting, Page 104](#)
- → [Function Delay for switching on and off, Page 106](#)
- → [Function Flashing, Page 107](#)

The selected time function is integrated into the function chain for the output.

More information: → [Function diagram Switch Actuator, Page 87](#).

4.2.10.1 Function Staircase lighting

This function is parameterized in the following parameter window:

- [Staircase lighting](#)

The function *Staircase lighting* can be used for time-controlled lighting (e.g. staircase lighting) or to control automatically an application with a similar function.

Note

If a delay is used for Scene recall (→ parameter *Delay*), the output does not react to the functions *Staircase lighting* and *Delay for switching on and off* → [Function diagram Switch Actuator, Page 87](#).

The switch-on duration is defined in the parameter *Staircase lighting time*.

Depending on the option selected in the parameter *Switching reaction of staircase lighting on telegram value 0/1*, the receipt of a telegram with the value 0 or 1 on one of the following Group Objects produces switching:

- [Switch](#)
- [Switch \(Central\)](#)
- [Scene 1 ... 64](#)
- [Scene 1 ... 64 \(Central\)](#)
- [Status Result \[Logic\]](#)
- [Status Result \[Threshold\]](#)

If the contact is defined as normally opened in the parameter *Reaction of output*, the contact is closed on receipt of a switch-on value and opened after the staircase lighting time has elapsed.

If the contact is defined as normally closed in the parameter *Reaction of output*, the contact is opened on receipt of a switch-on value and closed after the staircase lighting time has elapsed.

The function *Staircase lighting* can notify of the imminent switching off (→ parameter *Warning time*). The warning time starts after the staircase lighting time has elapsed. The type of warning is defined in the parameter *Warning before switching off the staircase lighting*:

- Via the Group Object [Warning staircase lighting](#):
The Group Object is set to the value 1 at the start of the warning time. The Group Object is set to the value 0 when the warning time elapses. The Group Object can be used to switch a warning light.
- Via short switching off/on:
The output is briefly switched off and then back on during the warning time. The number of Off/On changes can be defined in the parameter [Number of Off/On changes](#). The first Off/On change takes place at the beginning of the warning time. Additional Off/On changes are uniformly distributed over the remaining warning time.

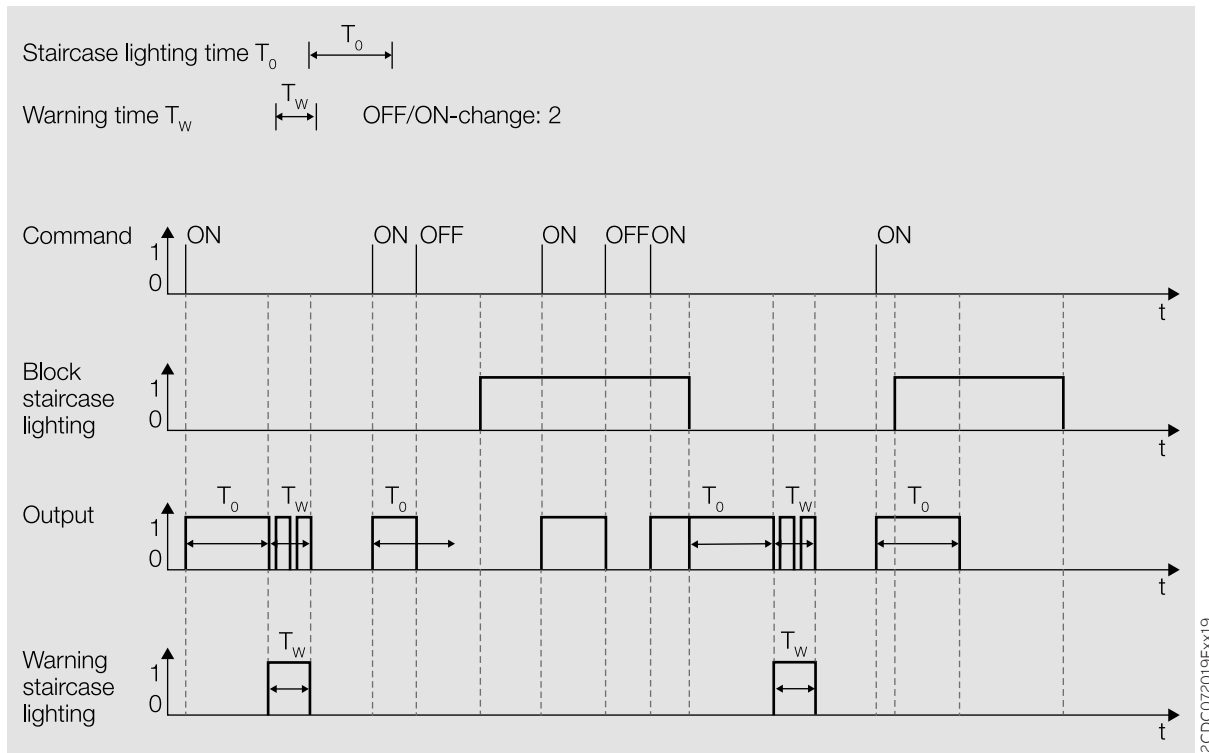

Fig. 34: Switch-on/switch-off reaction of the function Staircase lighting

2CDC072019Fxx19

4.2.10.1.1

Extending staircase lighting time (retriggering/pumping)

The staircase lighting time can be restarted if the option *Yes* is selected in the parameter *Staircase lighting time can be started again*.

Retriggering

The staircase lighting time can be restarted any number of times if the option *No, can only be started again* is selected in the parameter *Staircase lighting time extendable (pumping)*.

Pumping

If the option “Up to max. x times staircase lighting time” ($x = 2 \dots 5$) is selected in the parameter *Staircase lighting time extendable (pumping)*, the staircase lighting time can be extended to max. five times the duration. If further switch-on commands are received during the staircase lighting time or during the warning time, the staircase lighting time is extended by a further staircase lighting time.

The following diagram shows the reaction on extension to quintuple the staircase lighting time:

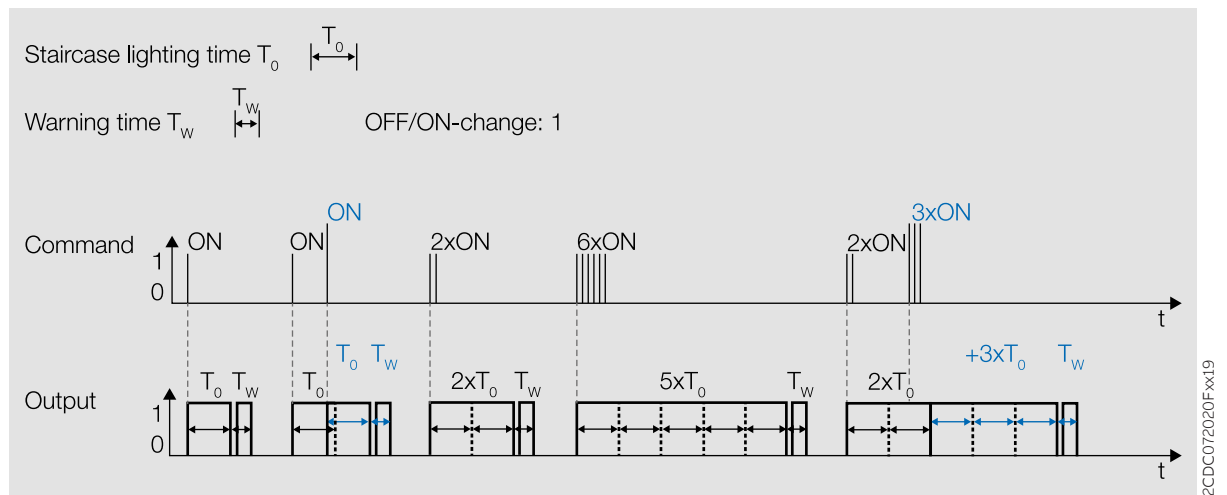

Fig. 35: Extending staircase lighting time (retriggering/pumping)

4.2.10.1.2

Block staircase lighting

The function *Staircase lighting* can be blocked via the Group Object *Block staircase lighting*. If the function *Staircase lighting* is blocked, the switch-on command is forwarded without time function in the function chain (→ [Function diagram Switch Actuator, Page 87](#)) and the output reacts according to its parameterization.

4.2.10.1.3

Permanent on

If the function *Staircase lighting* is activated, the output can be permanently switched on via the Group Object *Staircase lighting permanent on*. If Permanent on operation is activated, the output remains switched on. Other functions continue to run in the background, but they do not trigger any switching operation. If Permanent on operation is deactivated, the output reacts to the Group Object *Switch*.

The parameter *Restart staircase lighting time after permanent on* can be used to define how the lighting reacts after the end of Permanent ON operation.

After a download or bus voltage recovery, the Permanent on operation state from before the download or bus voltage failure is restored.

4.2.10.2

Function Delay for switching on and off

This function is parameterized in the following parameter window:

- *Delay for switching on and off*

Using the function *Delay for switching on and off*, the effect of a switching command received on one of the following Group Objects can be delayed:

- *Switch*
- *Switch (Central)*
- *Scene 1 ... 64*
- *Scene 1 ... 64 (Central)*
- *Status Result [Logic]*
- *Status Result [Threshold]*

i Note

If a delay is used for Scene recall (→ parameter *Delay*), the output does not react to the functions *Staircase lighting* and *Delay for switching on and off* → [Function diagram Switch Actuator, Page 87](#).

The duration of the delay is set in the following parameters:

- [Delay for switching on](#)
- [Delay for switching off](#)

Reaction of the delay for switching on:

- The delay for switching on starts after the reception of a switch-on command (telegram with the telegram value 1).
- If a switch-on command is received during the delay for switching on, the time for the delay for switching on restarts.
- If a switch-off command is received during the delay for switching on, the switch-on is discarded.

Reaction of the delay for switching off:

- The delay for switching off starts after the reception of a switch-off command (telegram with the telegram value 0).
- If a switch-off command is received during the delay for switching off, the time for the delay for switching off restarts.
- If a switch-on command is received during the delay for switching off, the switch-off is discarded.

i Note

Whether the relay contact is opened or closed depends on the setting in the parameter [Reaction of output](#).

4.2.10.3

Function Flashing

This function is parameterized in the following parameter window:

- [Flashing](#)

The function *Flashing* can be used to switch the relay contact alternately after receipt of a switch-on command.

The switch-on command is issued via the Group Object [Flashing](#). Each switch-on command restarts the flashing cycle.

The parameter [Flashing if Group Object "Flashing" is](#) can be used to define the telegram value with which a flashing cycle can be started and prematurely ended.

The number and duration of the flashing cycles can be defined in the following parameters:

- [Time for on](#)
- [Time for off](#)
- [Number of flashing cycles](#)

Each flashing cycle begins with the On state. Whether the relay contact is opened or closed depends on whether the output is defined as a normally closed contact or normally opened contact in the parameter [Reaction of output](#).

Each flashing cycle begins with the Off state. The position of the relay contact after the end of the flashing cycle can be specified in the parameter [Reaction after flashing](#).

If the function *Flashing* is active, the output does not react to other switching commands → [Function diagram Switch Actuator, Page 87](#).

i Note

If the function *Flashing* is used:

- Pay attention to the service life of the lighting equipment.
- Take into account the service life of the switching contacts → Technical data.

Note

Each relay can perform only a limited number of switching operations per minute → Technical data. A large number of switching operations per minute can delay switching.

4.3 Integration into i-bus® Tool

i-bus® Tool can be used to read the data from connected devices. It can also be used to simulate values and test the following functions:

- Function of the physical inputs and outputs

If there is no communication between the devices and i-bus® Tool, the simulated values cannot be sent on the bus.

For more information → parameter *i-bus® Tool access*.

i-bus® Tool can be downloaded free of charge from the company homepage (www.abb.com/knx).

Note

The interface to i-bus® Tool is available from the following software versions:

- Application from V1.2
- Firmware from V0.2.0

4.4 Special operating states

The devices' reaction on bus voltage failure, after bus voltage recovery and after ETS download can be set in the device parameters.

4.4.1 Reaction on bus voltage failure

Bus voltage failure describes the failure of the bus voltage, e.g. due to a power failure.

The reaction of the Switch Actuator outputs can be defined in the parameter window *Basic settings [Switch Actuator]*, in the parameter *Switching reaction on bus voltage failure*.

The reaction of the Shutter Actuator output pairs can be defined in the parameter window *Basic settings [Shutter Actuator]*, in the parameter *Blind/Shutter reaction on bus voltage failure*.

4.4.2 Reaction after bus voltage recovery

Bus voltage recovery is the state that exists after the bus voltage is restored. The devices will restart after bus voltage recovery.

The time set in the parameter *Sending and switching delay after bus voltage recovery* is awaited before the devices perform an action.

The reaction of the Switch Actuator outputs can be defined in the parameter window *Basic settings [Switch Actuator]*, in the parameter *Reaction after bus voltage recovery [Switch Actuator]*.

The reaction of the Shutter Actuator output pairs can be defined in the parameter window *Basic settings [Shutter Actuator]*, in the parameter *Reaction after bus voltage recovery [Shutter Actuator]*.

4.4.3 Reaction on ETS reset

An ETS reset restarts the ETS application in the devices. ETS reset can be performed in ETS using the Commissioning menu item, in the function *Reset device* (from ETS version 6 *Restart device*).

During an ETS reset, the device reacts the same way as during bus voltage failure.

The reaction of the Shutter Actuator output pairs can be defined in the parameter window *Basic settings [Shutter Actuator]*, in the parameter *Blind/Shutter reaction on bus voltage failure*.

The reaction of the Switch Actuator outputs can be defined in the parameter window *Basic settings [Switch Actuator]*, in the parameter *Switching reaction on bus voltage failure*.

4.4.4 Reaction during download

Downloading describes loading a modified or updated ETS application onto the devices. The devices are not ready to operate during a download.

Reaction of the Shutter Actuator output pairs:

Active movements are stopped at the start of the download. The reaction after download can be defined in the parameter window *Basic settings [Shutter Actuator]*, in the parameter *Reaction after ETS download [Shutter Actuator]*.

Reaction of the Switch Actuator outputs:

The positions of the relay contacts are blocked at the start of the download. The reaction after download can be defined in the parameter window *Basic settings [Switch Actuator]*, in the parameter *Reaction after ETS download [Switch Actuator]*.

Note

The device will no longer operate after the application is uninstalled or the download is canceled.

- ▶ Download again.

5 Mounting and installation

5.1 Information about mounting



DANGER – Severe injuries due to touch voltage

Electric feedback from different phase conductors can cause contact voltages and lead to serious injuries.

- ▶ Operate the device only in a closed housing (distribution board).
- ▶ Disconnect all phases before working on the electrical connection.

The device can be mounted in any position as required on a 35 mm mounting rail.

The electrical connection to the loads is made using screw terminals. The connection to the bus (ABB i-bus® KNX) is made using the bus connection terminal supplied. The terminal designation is located on the housing.

Note

The maximum permissible current consumption on a KNX line must not be exceeded.

- ▶ During planning and installation, ensure that the KNX line is correctly dimensioned. The device has a maximum current consumption of 12 mA.

5.2 Mounting on mounting rail

Note

No additional tools are required for mounting on a mounting rail.

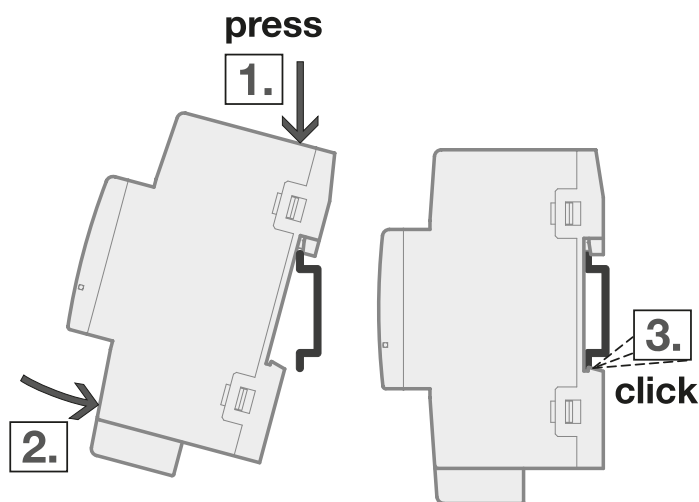

Fig. 36: Mounting on mounting rail

1. Place the mounting rail holder on the upper edge of the mounting rail and push down.
2. Push the lower part of the device toward the mounting rail until the mounting rail holder engages.
 - ⇒ The device is now mounted on the mounting rail.
3. Relieve the pressure on the top of the housing.

6 Commissioning

6.1 Prerequisites for commissioning

A PC with ETS and a connection to the bus (ABB i-bus® KNX), e.g. via a KNX interface, are required to commission the device.

- Required ETS version: 5.6 or higher
- Product-specific application: installed

6.2 Commissioning overview

After the bus voltage is activated for the first time, the following factory settings will be selected automatically:

- Physical address of the device: 15.15.255
- ETS application: preloaded
- Manual operation: enabled
- Operating mode of outputs: Shutter Actuator (in pairs)
- Switching contact position: open

The device can be programmed only using ETS.

Note

The complete ETS application can be downloaded again if required. Downloads may take longer after an application is uninstalled or when changing applications.

6.3 Putting device into operation



CAUTION – Device damage to the shutter/blind motor

Transport could have changed the relays' contact positions. Undefined contact positions can simultaneously energize the Up and Down contacts. The connected shutter/blind motor will be destroyed.

- ▶ Switch on KNX bus voltage to establish a defined state of the relays.



CAUTION

The outputs on the device are not interlocked mechanically. Connecting shutter/blind motors to Switch Actuator outputs will result in damage to the shutter/blind motor.

- ▶ Connect shutter/blind motors only to Shutter Actuator output pairs.



CAUTION

Setting a reversing time that is too short can damage the connected drive.

- ▶ Observe the technical data of the connected drive.

1. Connect the device to the bus (ABB i-bus® KNX).
2. Switch on bus voltage.
 - ⇒ All switching contacts are open.
3. Switch on power supply of the connected loads.
 - ⇒ Device is ready for operation.

6.4 Assignment of the physical address

i Note

If it is set in ETS that the application is to be downloaded during programming, the download will begin after assignment of the physical address.

Triggering assignment of the physical address via ETS:

1. Press *Programming* button.
 - ⇒ Programming mode active. *Programming* LED lights up.
2. Start programming process in ETS.
 - ⇒ Physical address is assigned. Device restarts.

i Note

The device performs an ETS reset during assignment of the physical address. All states are reset.

6.5 Software/application

6.5.1 Download reaction

Depending on the PC, it can take up to 90 seconds for the progress bar to appear during a download.

Using an interface that supports download via "long frames" (e.g. USB/S 1.2 or IPR/S 3.5.1) can greatly shorten the download time.

6.5.2 Copying, exchanging and converting

The following functions can be performed with the ETS app *ABBUpdate Copy Convert*:

- *Update*: Changes the application program to a higher or lower version while retaining the current configurations
- *Convert*: Transfers/adopts a configuration from an identical or compatible source device
- *Copy channel*: Copies a channel configuration to other channels on a multichannel device
- *Channel exchange*: Exchanges configurations between two channels on a multichannel device
- *Import/export*: Saves and reads device configurations as external files

The ETS app *ABBUpdate Copy Convert* can be downloaded free of charge from the KNX Shop → www.KNX.org.

7 Parameters

7.1 General

i Note

ETS (Engineering Tool Software) is used to parameterize the device.

The following sections describe the device parameters based on the parameter windows. The parameter windows have a dynamic design. Parameters are shown or hidden depending on parameterization and function.

The default values of the parameters are underlined, e.g.:

No (checkbox cleared)

Yes (checkbox ticked)

i Note

The default values in the ETS application can vary from the values stated in the product manual depending on the product variant.

i Note

The screenshots show an application for devices with manual operation.

i Note

A device with 24 channels (A ... X) is described below.

7.2 Parameter windows

7.2.1 Parameter windows Configuration

The following settings can be made in this parameter window:

- Enable outputs
- Define application for each output
- Enable functions *Logic* and *Threshold*
- Limit number of telegrams sent
- Activate i-bus® Tool access

 Note

The interface to i-bus® Tool is available from the following software versions:

- Application from V1.2
- Firmware from V0.2.0

Configuration

- + Device settings
- + Manual operation
- + Safety/Weather alarms
- + Logic/Threshold
- + Switch Actuator template
- + Shutter Actuator template
- + Shutter Actuator A+B:
- + Shutter Actuator C+D:
- + Shutter Actuator E+F:
- + Shutter Actuator G+H:
- + Shutter Actuator I+J:
- + Shutter Actuator K+L:
- + Shutter Actuator M+N:
- + Shutter Actuator O+P:
- + Shutter Actuator Q+R:
- + Shutter Actuator S+T:
- + Shutter Actuator U+V:
- + Shutter Actuator W+X:

i Firmware V0.2.0 or higher is required for using the i-bus® Tool. Update via ETS app "Firmware-Update 2.0".

Channel configuration

	Enable	Application
Output A	<input checked="" type="checkbox"/>	<input checked="" type="radio"/> Shutter Actuator <input type="radio"/> Switch Actuator
Output B		
Output C	<input checked="" type="checkbox"/>	<input checked="" type="radio"/> Shutter Actuator <input type="radio"/> Switch Actuator
Output D		
Output E	<input checked="" type="checkbox"/>	<input checked="" type="radio"/> Shutter Actuator <input type="radio"/> Switch Actuator
Output F		
Output G	<input checked="" type="checkbox"/>	<input checked="" type="radio"/> Shutter Actuator <input type="radio"/> Switch Actuator
Output H		
Output I	<input checked="" type="checkbox"/>	<input checked="" type="radio"/> Shutter Actuator <input type="radio"/> Switch Actuator
Output J		
Output K	<input checked="" type="checkbox"/>	<input checked="" type="radio"/> Shutter Actuator <input type="radio"/> Switch Actuator
Output L		
Output M	<input checked="" type="checkbox"/>	<input checked="" type="radio"/> Shutter Actuator <input type="radio"/> Switch Actuator
Output N		
Output O	<input checked="" type="checkbox"/>	<input checked="" type="radio"/> Shutter Actuator <input type="radio"/> Switch Actuator
Output P		
Output Q	<input checked="" type="checkbox"/>	<input checked="" type="radio"/> Shutter Actuator <input type="radio"/> Switch Actuator
Output R		
Output S	<input checked="" type="checkbox"/>	<input checked="" type="radio"/> Shutter Actuator <input type="radio"/> Switch Actuator
Output T		
Output U	<input checked="" type="checkbox"/>	<input checked="" type="radio"/> Shutter Actuator <input type="radio"/> Switch Actuator
Output V		
Output W	<input checked="" type="checkbox"/>	<input checked="" type="radio"/> Shutter Actuator <input type="radio"/> Switch Actuator
Output X		

Enable Logic/Threshold

- Logic/Threshold 1-4
- Logic/Threshold 5-8
- Logic/Threshold 9-12
- Logic/Threshold 13-16
- Logic/Threshold 17-20
- Logic/Threshold 21-24

Maximum number of sent telegrams

In period (0 = deactivated) ss

i-bus® Tool access

Fig. 37: Parameter window Configuration

This parameter window includes the following parameters:

- [Enable output X + Y, Page 159](#)
 - [Application, Page 155](#)
- [Enable Logic/Threshold x-y, Page 193](#)
- [Maximum number of sent telegrams, Page 193](#)
- [In period \(0 = deactivated\), Page 181](#)
- [i-bus® Tool access, Page 248](#)

Prerequisites for visibility

- The parameter window is always visible.

7.2.2 Parameter windows Device settings

The following settings can be made in this parameter window:

- Set sending and switching delay
- Enable Group Object [Request status values](#)
- Enable Group Object [In operation](#)
- Enable central and device-specific Group Objects

Configuration	Device settings
– Device settings	
Device settings	
+ Manual operation	Sending and switching delay after bus voltage recovery <input type="text" value="00:00:02"/> hh:mm:ss
+ Safety/Weather alarms	Value after sending and switching delay has expired <input checked="" type="radio"/> Last value received <input type="radio"/> Ignore received values
+ Logic/Threshold	Enable Time Group Objects for setting of device time <input type="text" value="No"/>
+ Switch Actuator template	Enable Group Object "Request Status values" <input type="checkbox"/>
+ Shutter Actuator template	Enable central Group Object "Receive load shedding stage" <input checked="" type="checkbox"/>
+ Shutter Actuator A+B:	Enable central Group Objects "Shutter" <input type="checkbox"/>
+ Shutter Actuator C+D:	Enable central Group Object "Scene 1 ... 64" <input type="checkbox"/>
+ Shutter Actuator E+F:	Enable Group Object "In operation" <input type="text" value="No"/>
+ Shutter Actuator G+H:	

Fig. 38: Parameter window Device settings

This parameter window includes the following parameters:

- [Sending and switching delay after bus voltage recovery](#), Page 206
- [Value after sending and switching delay has expired](#), Page 244
- [Enable Time Group Objects for setting of device time](#), Page 189
 - [Request Date/Time via Group Object](#), Page 170
- [Enable Group Object "Request status values"](#), Page 186
- [Enable central Group Object "Switch"](#), Page 248
- [Enable central Group Object "Receive load shedding stage"](#), Page 247
- [Enable central Group Objects "Shutter"](#), Page 247
- [Enable central Group Object "Scene 1 ... 64"](#), Page 248
- [Enable Group Object "In operation"](#), Page 182
 - [Sending cycle](#), Page 206

Prerequisites for visibility

- The parameter window is always visible.

7.2.3 Parameter windows Manual operation

The following settings can be made in this parameter window:

- Enable operating state *Manual operation*
- Automatically reset the device to operating state *KNX operation*

More information: → [Manual operation, Page 277](#).

Configuration	Manual operation
+ Device settings	Enable manual operation <input checked="" type="checkbox"/>
- Manual operation	Automatic reset from manual operation to KNX operation <input checked="" type="checkbox"/>
Manual operation	Automatic reset after <input type="text" value="00:05:00"/> hh:mm:ss
+ Safety/Weather alarms	State after end of manual operation <input type="radio"/> Manually set state retained
+ Logic/Threshold	<input checked="" type="radio"/> Refreshed KNX state
+ Switch Actuator template	i Manual operation can be blocked by higher priorities

This parameter window includes the following parameters:

- [Enable manual operation, Page 193](#)
 - [Automatic reset from manual operation to KNX operation, Page 161](#)
 - [Automatic reset after, Page 160](#)
 - [State after end of manual operation, Page 249](#)

Prerequisites for visibility

- The parameter window is always visible.

7.2.4 Parameter windows Safety/Weather alarms

The following settings can be made in this parameter window:

- Activate safety priorities
- Activate weather alarms

The safety priorities and the weather alarms apply to the entire device, but each output can react differently to the receipt of a safety priority or a weather alarm. The reaction of the individual outputs can be defined in the respective parameter windows.

More information: → [Safety functions, Page 88](#).

Configuration	Safety/Weather alarms													
+ Device settings	Read safety Group Objects after bus voltage recovery and download <input type="checkbox"/>													
+ Manual operation														
- Safety/Weather alarms	Safety priority for Switch Actuator operation													
+ Safety/Weather alarms	<div style="border: 1px solid #ccc; padding: 5px;"> <p>i The reaction on active safety priority must be specified in the parameter window "Safety" for the Switch Actuator channels.</p> </div> <table border="1"> <thead> <tr> <th>Group Object</th> <th>Enable</th> <th>Cyclical monitoring</th> </tr> </thead> <tbody> <tr> <td>Safety priority 1</td> <td><input type="checkbox"/></td> <td></td> </tr> <tr> <td>Safety priority 2</td> <td><input type="checkbox"/></td> <td></td> </tr> <tr> <td>Safety priority 3</td> <td><input type="checkbox"/></td> <td></td> </tr> </tbody> </table>		Group Object	Enable	Cyclical monitoring	Safety priority 1	<input type="checkbox"/>		Safety priority 2	<input type="checkbox"/>		Safety priority 3	<input type="checkbox"/>	
Group Object	Enable	Cyclical monitoring												
Safety priority 1	<input type="checkbox"/>													
Safety priority 2	<input type="checkbox"/>													
Safety priority 3	<input type="checkbox"/>													
+ Logic/Threshold	Weather alarms for Shutter Actuator operation													
+ Switch Actuator template	<div style="border: 1px solid #ccc; padding: 5px;"> <p>i The reaction with weather alarms active must be specified in the parameter window "Safety/Weather alarms" for the shutter channels.</p> </div>													
+ Shutter Actuator template	Order of priority for weather alarms	1.Wind alarm - 2.Rain alarm - 3.Frost alarm ▼												
+ Shutter Actuator A+B:	Enable Group Object "Wind alarm 1"	<input type="checkbox"/>												
+ Shutter Actuator C+D:	Enable Group Object "Wind alarm 2"	<input type="checkbox"/>												
+ Shutter Actuator E+F:	Enable Group Object "Wind alarm 3"	<input type="checkbox"/>												
+ Shutter Actuator G+H:	Enable Group Object "Rain alarm"	<input type="checkbox"/>												
+ Shutter Actuator I+J:	Enable Group Object "Frost alarm"	<input type="checkbox"/>												
+ Shutter Actuator K+L:														
+ Shutter Actuator M+N:														
+ Shutter Actuator O+P:														
+ Shutter Actuator Q+R:														

Fig. 39: Parameter window Safety/Weather alarms

This parameter window includes the following parameters:

- [Read safety Group Objects after bus voltage recovery and download, Page 207](#)
- [Enable Group Object "Safety priority x", Page 183](#)
 - [Cyclical monitoring, Page 250](#)
- [Order of priority for weather alarms, Page 198](#)
- [Enable Group Object "Wind alarm x", Page 186](#)
 - [Cyclical monitoring, Page 250](#)
- [Enable Group Object "Rain alarm", Page 182](#)
 - [Cyclical monitoring, Page 250](#)
- [Enable Group Object "Frost alarm", Page 181](#)
 - [Cyclical monitoring, Page 250](#)

Prerequisites for visibility

- The parameter window is always visible.

7.2.5 Parameter windows Logic/Threshold

The functions *Logic* and *Threshold* can be set individually for each output in the subordinate parameter windows.

Prerequisites for visibility

- Parameter window *Configuration* \ Parameter *Enable Logic/Threshold x-y* \ Option *Yes*

7.2.5.1 Parameter windows Logic/Threshold x

The following settings can be made in this parameter window:

- Parameterize function *Logic*
- Parameterize function *Threshold*

The functions *Logic* and *Threshold* can be used independent of other functions. The results of the functions *Logic* and *Threshold* can be linked internally with any output (→ parameter *Output reacts to*) and/or sent on the bus (ABB i-bus® KNX).

More information → [Function Logic, Page 93](#), → [Function Threshold, Page 94](#).

Configuration	Logic
+ Device settings	Function of the logic gate AND ▾
+ Manual operation	Value of Group Object "Connection A" after bus voltage recovery <input type="radio"/> 1 <input checked="" type="radio"/> 0
+ Safety/Weather alarms	Value of Group Object "Connection B" after bus voltage recovery <input type="radio"/> 1 <input checked="" type="radio"/> 0
- Logic/Threshold	i The result is recalculated only if a value is received on one of the two Group Objects "Connection A" or "Connection B".
Logic/Threshold 1	Read input Group Objects after bus voltage recovery and download <input type="checkbox"/>
Logic/Threshold 2	Invert result <input type="checkbox"/>
Logic/Threshold 3	Enable Group Object "Status Result" <input type="checkbox"/>
Logic/Threshold 4	
Logic/Threshold 5	

Fig. 40: Parameter window Logic/Threshold x

This parameter window includes the following parameters:

- [Function of the logic gate, Page 176](#)
- [Value of Group Object "Connection A" after bus voltage recovery, Page 240](#)
- [Value of Group Object "Connection B" after bus voltage recovery, Page 241](#)
- [Read input Group Objects after bus voltage recovery and download, Page 172](#)
- [Invert result, Page 174](#)
- [Enable Group Object "Status Result", Page 184](#)
 - [Send value of Group Object "Status Result", Page 237](#)
- [GATE blocks if Group Object "Connection A" equals, Page 212](#)
- [Data point type of Group Object "Threshold input", Page 169](#)
- [Upper threshold, Page 196](#)
- [Lower threshold, Page 222](#)
- [Change thresholds via Group Objects, Page 205](#)
- [Change thresholds via i-bus® Tool, Page 205](#)
 - [Overwrite thresholds on download, Page 204](#)
- [Result if upper threshold is exceeded, Page 174](#)
- [Min. duration of the overshoot, Page 194](#)
- [Monitor range between thresholds, Page 167](#)
 - [Minimum dwell time between the thresholds, Page 195](#)
- [Result if lower threshold is dropped below, Page 174](#)
- [Min. duration of the undershoot, Page 194](#)
- [Read input Group Objects after bus voltage recovery and download, Page 172](#)
- [Enable Group Objects "Status Result" and "Status Input value between thresholds", Page 187](#)
 - [Send values of Group Objects "Status Result" and "Status Input value between thresholds", Page 245](#)

 Note

The interface to i-bus® Tool is available from the following software versions:

- Application from V1.2
- Firmware from V0.2.0

Prerequisites for visibility

- Parameter window *Configuration* \ Parameter *Enable Logic/Threshold x-y* \ Option *Yes*
- The parameter window is in the parameter window *Logic/Threshold*.

7.2.6 Parameter windows Switch Actuator template

The functions can be set for all Switch Actuator outputs in this parameter window.

i Note

It can be decided for each Switch Actuator output whether parameterization from the template is used. The individual setting for a Switch Actuator output is made in the respective parameter window [Switch Actuator X](#).

The parameterization options in the template and in the parameter window for the Switch Actuator output are identical. The following parameter windows are available in the template:

- [Basic settings \[Switch Actuator\]](#)
- [Safety](#)
- [Load shedding](#)
- [Delay for switching on and off](#)
- [Staircase lighting](#)
- [Flashing](#)
- [Scene assignments \[Switch Actuator\]](#)

Prerequisites for visibility

- The parameter window is always visible.

7.2.7 Parameter windows Shutter Actuator template

The functions can be set for all Shutter Actuator output pairs in this parameter window.

Note

It can be decided for each Shutter Actuator output pair whether parameterization from the template is used. The individual setting for a Shutter Actuator output pair is made in the respective parameter window *Shutter Actuator X+Y*.

The parameterization options in the template and in the parameter window for the Shutter Actuator output pair are identical. The following parameter windows are available in the template:

- *Basic settings [Shutter Actuator]*
- *Drive*
- *Blind/Shutter*
- *Safety/Weather alarms*
- *Automatic sun protection*
- *status messages*
- *Scene assignments [Shutter Actuator]*

Prerequisites for visibility

- The parameter window is always visible.

7.2.8 Parameter windows Shutter Actuator X+Y

The functions can be set individually for each Shutter Actuator output pair in the subordinate parameter windows.

Note

If several Shutter Actuator output pairs are to be set to the same values, parameterization can be performed in the parameter window [Shutter Actuator template](#).

Note

The layout in the parameter window is identical for all outputs. The settings are explained in the following based on examples.

Prerequisites for visibility

- Parameter window [Configuration](#) \ Parameter [Enable output X + Y](#) \ Option *Yes*

7.2.8.1 Parameter windows Shutter Actuator functions

The following settings can be made in this parameter window:

- Selection of application
- Selection of operating mode
- Enable of functions

Configuration	Shutter Actuator functions
+ Device settings	Description <input type="text"/>
+ Manual operation	Operating mode <input checked="" type="radio"/> Blind/Shutter control with slat adjustment <input type="radio"/> Blind/Shutter control without slat adjustment
+ Safety/Weather alarms	i To control shutters, vertical blinds and other shading systems with slats, etc.
+ Logic/Threshold	Enable function Safety/Weather alarms <input type="checkbox"/>
+ Switch Actuator template	Enable function Automatic sun protection <input type="checkbox"/>
+ Shutter Actuator template	Enable function Scenes <input type="checkbox"/>
- Shutter Actuator A+B:	Output reacts to <input type="text" value="No Logic/Threshold function"/>
Shutter Actuator functions	i Enable the function Logic/Threshold in the parameter window Logic/Threshold.
Basic settings	

Fig. 41: Parameter window Functions Shutter Actuator

This parameter window includes the following parameters:

- [Description, Page 168](#)
- [Operating mode, Page 168](#)
- [Enable function Safety/Weather alarms, Page 178](#)
- [Enable function Automatic sun protection, Page 179](#)
- [Enable function Scenes \[Shutter Actuator\], Page 179](#)
- [Output reacts to, Page 157](#)
 - [Reaction on result "0" \[Shutter Actuator\], Page 222](#)
 - [Scene assignment, Page 210](#)
 - [Position height \(0 % = top; 100 % = bottom\), Page 197](#)
 - [Position slat \(0 % = open; 100 % = closed\), Page 197](#)
 - [Reaction on result "1" \[Shutter Actuator\], Page 224](#)
 - [Scene assignment, Page 210](#)
 - [Position height \(0 % = top; 100 % = bottom\), Page 197](#)
 - [Position slat \(0 % = open; 100 % = closed\), Page 197](#)

Prerequisites for visibility

- Parameter window [Configuration](#)
 - Parameter [Enable output X + Y](#) \ Option Yes
 - Parameter [Application](#) \ Option *Shutter Actuator*
- The parameter window is in the parameter window [Shutter Actuator X+Y](#).

7.2.8.2 Parameter windows Basic settings [Shutter Actuator]

The following settings can be made in this parameter window:

- Connection with the central shutter Group Objects
- Connection with the functions *Logic* and *Threshold*
- Channel-specific settings

i Note

If several Shutter Actuator output pairs are to be set to the same values, parameterization can be performed in the parameter window *Shutter Actuator template*.

Fig. 42: Parameter window Basic settings

This parameter window includes the following parameters:

- [Parameter setting, Page 196](#)
 - [Output reacts to central shutter Group Objects, Page 158](#)
 - [Blind/Shutter reaction on bus voltage failure, Page 161](#)
 - [Reaction after bus voltage recovery \[Shutter Actuator\], Page 229](#)
 - [Position height \(0 % = top; 100 % = bottom\), Page 197](#)
 - [Position slat \(0 % = open; 100 % = closed\), Page 197](#)
 - [Reaction after ETS download \[Shutter Actuator\], Page 230](#)
 - [Position height \(0 % = top; 100 % = bottom\), Page 197](#)
 - [Position slat \(0 % = open; 100 % = closed\), Page 197](#)

Prerequisites for visibility

- Parameter window *Configuration*
 - Parameter *Enable output X + Y* \ Option *Yes*
 - Parameter *Application* \ Option *Shutter Actuator*
- The parameter window is in the parameter window *Shutter Actuator X+Y*.

7.2.8.3 Parameter windows Drive

The following settings can be made in this parameter window:

- Set the Blind/Shutter travel time
- Trigger reference movement
- Set reversing time for drive
- Set delay time for drive

More information: → [Drive settings, Page 283](#).

Note

If several Shutter Actuator output pairs are to be set to the same values, parameterization can be performed in the parameter window *Shutter Actuator template*.

Configuration	Drive
+ Device settings	Parameter setting <input type="radio"/> Apply from template <input checked="" type="radio"/> Individual
+ Manual operation	Travel time up <input type="text" value="00:01:00"/> hh:mm:ss
+ Safety/Weather alarms	Travel time down <input type="text" value="00:01:00"/> hh:mm:ss
+ Logic/Threshold	Disconnect output from power after <input type="text" value="End position + 10 % overrun"/>
+ Switch Actuator template	Enable Group Object "Trigger reference movement" <input type="checkbox"/>
+ Shutter Actuator template	Reversing time <input type="text" value="500"/> ms
- Shutter Actuator A+B:	! Pay attention to technical data for the drive! If bus voltage failure occurs, a reversing time of 1 second is always used.
Shutter Actuator functions	Delay time for drive <input checked="" type="radio"/> Default <input type="radio"/> User-defined
Basic settings	
Drive	

Fig. 43: Parameter window Drive

This parameter window includes the following parameters:

- [Parameter setting, Page 196](#)
 - [Travel time up, Page 176](#)
 - [Travel time down, Page 176](#)
 - [Disconnect output from power after, Page 158](#)
 - [Enable Group Object "Trigger reference movement", Page 182](#)
 - [Position after reference movement, Page 198](#)
 - [Reversing time, Page 220](#)
 - [Delay time for drive, Page 235](#)
 - [Start-up delay, Page 154](#)
 - [Coasting delay, Page 159](#)
 - [Minimum run time for drive, Page 194](#)

Prerequisites for visibility

- Parameter window *Configuration*
 - Parameter *Enable output X + Y* \ Option Yes
 - Parameter *Application* \ Option *Shutter Actuator*
- The parameter window is in the parameter window *Shutter Actuator X+Y*.

7.2.8.4 Parameter windows Blind/Shutter

Note
 If several Shutter Actuator output pairs are to be set to the same values, parameterization can be performed in the parameter window *Shutter Actuator template*.

The following settings can be made in this parameter window:

- Move to position
- Enable Group Objects "Move to position Height/Slat"
- Determine slat adjustment time
- Set travel range limit
- Set dead times

More information: → [Blind/Slat settings, Page 287](#).

Note
 All functions, parameters and Group Objects in the following section that refer to slat settings are available only in the following operating mode:

- *Blind/Shutter control with slat adjustment*

<p>Configuration</p> <ul style="list-style-type: none"> + Device settings + Manual operation + Safety/Weather alarms + Logic/Threshold + Switch Actuator template + Shutter Actuator template - Shutter Actuator A+B: <ul style="list-style-type: none"> Shutter Actuator functions Basic settings Drive Blind/Shutter Status Messages + Shutter Actuator C+D: + Shutter Actuator E+F: 	<p>Blind/Shutter</p> <hr/> <p>Parameter setting <input type="radio"/> Apply from template <input checked="" type="radio"/> Individual</p> <hr/> <p>Move to position Direct ▾</p> <p>Enable Group Objects "Move to position Height/Slat" <input type="checkbox"/></p> <hr/> <p>Determine slat adjustment time <input checked="" type="radio"/> Via duration of slat adjustment <input type="radio"/> Via total duration for slat turning</p> <p>Duration of slat adjustment/step 200 ms</p> <p>Number of slat adjustments/steps (from 0 % = open to 100 % = closed) 7</p> <hr/> <p>Limit step commands to number of slat adjustments <input checked="" type="checkbox"/></p> <p>Total turning of slats after down movement <input type="checkbox"/></p> <p>Position of slat after reaching lower end position (100 % = deactivated) 100 %</p> <hr/> <p>Limit travel range via Group Object No ▾</p> <hr/> <p>Set dead times <input checked="" type="radio"/> Default <input type="radio"/> User-defined</p>
--	--

Fig. 44: Parameter window Blind/Shutter

This parameter window includes the following parameters:

- [Parameter setting, Page 196](#)
 - [Move to position, Page 197](#)
 - [Enable Group Objects "Move to position Height/Slat", Page 186](#)
 - [Determine slat adjustment time, Page 190](#)
 - [Duration of slat adjustment/step, Page 173](#)
 - [Total duration for slat turning from 0 % - 100 %, Page 180](#)
 - [Number of slat adjustments/steps \(from 0 % = open to 100 % = closed\), Page 155](#)
 - [Limit step commands to number of slat adjustments, Page 208](#)
 - [Total turning of slats after down movement, Page 235](#)
 - [Slat position after reaching lower end position \(100 % = deactivated\), Page 190](#)
 - [Limit travel range via Group Object, Page 175](#)
 - [Upper limit \(0 % = top; 100 % = bottom\), Page 195](#)
 - [Lower limit \(0 % = top; 100 % = bottom\), Page 221](#)
 - [Upper limit valid for Automatic sun protection commands, Page 196](#)
 - [Upper limit valid for direct commands, Page 195](#)
 - [Lower limit valid for Automatic sun protection commands, Page 221](#)
 - [Lower limit valid for direct commands, Page 221](#)
 - [Set dead times, Page 214](#)
 - [Dead time Blind/Shutter movement from lower end position \(100 %\), Page 212](#)
 - [Dead time slat movement \(from 100 % closed\), Page 213](#)
 - [Dead time slat adjustment on change of direction, Page 214](#)
 - [Dead time Blind/Shutter adjustment on change of direction, Page 212](#)
- [Tensioning/Slot positioning, Page 209](#)
 - [Duration for tensioning, Page 170](#)

Prerequisites for visibility

- Parameter window [Configuration](#)
 - Parameter [Enable output X + Y](#) \ Option *Yes*
 - Parameter [Application](#) \ Option *Shutter Actuator*
- The parameter window is in the parameter window [Shutter Actuator X+Y](#).

7.2.8.5 Parameter windows Safety/Weather alarms

Note

If several Shutter Actuator output pairs are to be set to the same values, parameterization can be performed in the parameter window *Shutter Actuator template*.

The following settings can be made in this parameter window:

- Parameterize reaction to weather alarms
- Parameterize reaction on forced operation and block
- Define position after cancellation of block, forced operation and weather alarms
- Define order of priority for weather alarms

More information: → [Safety functions of Shutter Actuator, Page 88](#).

Fig. 45: Parameter window Safety/Weather alarms

This parameter window includes the following parameters:

- [Parameter setting, Page 196](#)
- [Output reacts to wind alarm x, Page 157](#)
 - [Blind/Shutter reaction on wind alarm, Page 166](#)
 - [Scene assignment, Page 210](#)
 - [Position height \(0 % = top; 100 % = bottom\), Page 197](#)
 - [Position slat \(0 % = open; 100 % = closed\), Page 197](#)
- [Blind/Shutter reaction on rain alarm, Page 163](#)
 - [Scene assignment, Page 210](#)
 - [Position height \(0 % = top; 100 % = bottom\), Page 197](#)
 - [Position slat \(0 % = open; 100 % = closed\), Page 197](#)
- [Blind/Shutter reaction on frost alarm, Page 162](#)
 - [Scene assignment, Page 210](#)
 - [Position height \(0 % = top; 100 % = bottom\), Page 197](#)
 - [Position slat \(0 % = open; 100 % = closed\), Page 197](#)
- [Blind/Shutter reaction on block, Page 165](#)
 - [Scene assignment, Page 210](#)
 - [Position height \(0 % = top; 100 % = bottom\), Page 197](#)
 - [Position slat \(0 % = open; 100 % = closed\), Page 197](#)
- [Forced operation \(1 bit / 2 bit\) \[Shutter Actuator\], Page 249](#)
 - [Position height \(0 % = top; 100 % = bottom\), Page 197](#)
 - [Position slat \(0 % = open; 100 % = closed\), Page 197](#)
- [Blind/Shutter reaction on cancellation of weather alarm, block and forced operation, Page 164](#)
 - [Scene assignment, Page 210](#)
 - [Position height \(0 % = top; 100 % = bottom\), Page 197](#)
 - [Position slat \(0 % = open; 100 % = closed\), Page 197](#)
- [Deactivate Automatic sun protection on cancellation of weather alarms, block and forced operation, Page 207](#)
- [Order of priority of weather alarm, block and forced operation, Page 198](#)

Prerequisites for visibility

- Parameter window [Configuration](#)
 - Parameter [Enable output X + Y](#) \ Option *Yes*
 - Parameter [Application](#) \ Option *Shutter Actuator*
- Parameter window [Shutter Actuator X+Y](#) \ Parameter window [Shutter Actuator functions](#) \ Parameter [Enable function Safety/Weather alarms](#) \ Option *Yes*
- The parameter window is in the parameter window [Shutter Actuator X+Y](#).

7.2.8.6 Parameter windows Automatic sun protection

Note
 If several Shutter Actuator output pairs are to be set to the same values, parameterization can be performed in the parameter window *Shutter Actuator template*.

The following settings can be made in this parameter window:

- Parameterize function *Automatic sun protection*
- Parameterize switchover between *Automatic operation* and *Direct operation*

More information: → [Function Automatic sun protection, Page 100](#).

Configuration	Automatic sun protection	
+ Device settings	Parameter setting	<input type="radio"/> Apply from template <input checked="" type="radio"/> Individual
+ Manual operation	Deactivation of Automatic sun protection	<input type="radio"/> Via Group Object <input checked="" type="radio"/> Via Group Object or direct command
+ Safety/Weather alarms	Automatic reactivation of Automatic sun protection	<input type="checkbox"/>
+ Logic/Threshold	Enable Group Object "Block Automatic sun protection"	<input type="checkbox"/>
+ Switch Actuator template	Enable Group Object "Block direct operation"	<input type="checkbox"/>
+ Shutter Actuator template	Reaction on sun = 1 (sun)	Down <input type="text" value="00:00:00"/> hh:mm:ss
- Shutter Actuator A+B:	Reaction on sun = 0 (no sun)	Up <input type="text" value="00:00:00"/> hh:mm:ss
Shutter Actuator functions Basic settings Drive Blind/Shutter Automatic sun protection	Read Automatic sun protection Group Objects after bus voltage recovery and download	<input type="checkbox"/>
+ Shutter Actuator C+D:		

Fig. 46: Parameter window Automatic sun protection

This parameter window includes the following parameters:

- [Parameter setting](#), Page 196
 - [Deactivation of Automatic sun protection](#), Page 171
 - [Automatic reactivation of Automatic sun protection](#), Page 160
 - [Time for automatic reactivation of Automatic sun protection](#), Page 246
 - [Enable Group Object "Block automatic sun protection"](#), Page 183
 - [Enable Group Object "Block direct operation"](#), Page 181
 - [Reaction on sun = 1 \(sun\)](#), Page 226
 - Scene assignment*
 - [Position height \(0 % = top; 100 % = bottom\)](#), Page 197
 - [Position slat \(0 % = open; 100 % = closed\)](#), Page 197
 - [Delay for sun = 1](#), Page 234
 - [Reaction on sun = 0 \(no sun\)](#), Page 225
 - Scene assignment*
 - [Position height \(0 % = top; 100 % = bottom\)](#), Page 197
 - [Position slat \(0 % = open; 100 % = closed\)](#), Page 197
 - [Delay for sun = 0](#), Page 234
 - [Read Automatic sun protection Group Objects after bus voltage recovery and download](#), Page 208

Prerequisites for visibility

- Parameter window [Configuration](#)
 - Parameter [Enable output X + Y](#) \ Option *Yes*
 - Parameter [Application](#) \ Option *Shutter Actuator*
- Parameter window [Shutter Actuator X+Y](#) \ Parameter window [Shutter Actuator functions](#) \ Parameter [Enable function Automatic sun protection](#) \ Option *Yes*
- The parameter window is in the parameter window [Shutter Actuator X+Y](#).

7.2.8.7 Parameter windows Status Messages

Note

If several Shutter Actuator output pairs are to be set to the same values, parameterization can be performed in the parameter window [Shutter Actuator template](#).

The following settings can be made in this parameter window:

- Enable status Group Objects
- Define send behavior of the status Group Objects

Configuration	Status Messages
+ Device settings	Parameter setting <input type="radio"/> Apply from template <input checked="" type="radio"/> Individual
+ Manual operation	
+ Safety/Weather alarms	Enable Group Objects "Status Height/Slat" <input type="checkbox"/>
+ Logic/Threshold	Enable Group Objects "Status Upper/Lower end position" <input type="checkbox"/>
+ Switch Actuator template	Enable Group Object "Status Operability" <input type="checkbox"/>
+ Shutter Actuator template	Enable Group Objects "Status byte" <input type="text" value="No"/>
- Shutter Actuator A+B:	
Shutter Actuator functions	
Basic settings	
Drive	
Blind/Shutter	
Status Messages	

Fig. 47: Parameter window Status Messages

This parameter window includes the following parameters:

- [Parameter setting](#), Page 196
 - [Enable Group Objects "Status Height/Slat"](#), Page 188
 - [Send value of Group Objects "Status Height/Slat"](#), Page 242
 - [Enable Group Objects "Status Upper/Lower end position"](#), Page 187
 - [Send value of Group Objects "Status Upper/Lower end position"](#), Page 241
 - [Enable Group Object "Status Operability"](#), Page 184
 - [Send value of Group Object "Status Operability"](#), Page 237
 - [Enable Group Object "Status Automatic sun protection"](#), Page 185
 - [Send value of Group Object "Status Automatic sun protection"](#), Page 240
 - [Enable Group Objects "Status byte" \[Shutter Actuator\]](#), Page 188
 - [Send value of Group Objects "Status byte" \[Shutter Actuator\]](#), Page 243

Prerequisites for visibility

- Parameter window [Configuration](#)
 - Parameter [Enable output X + Y](#) \ Option Yes
 - Parameter [Application](#) \ Option [Shutter Actuator](#)
- The parameter window is in the parameter window [Shutter Actuator X+Y](#).

7.2.8.8 Parameter windows Scene assignments [Shutter Actuator]

Note

If several Shutter Actuator output pairs are to be set to the same values, parameterization can be performed in the parameter window *Shutter Actuator template*.

The following settings can be made in this parameter window:

- Enable Scene assignments
- Create Scenes

More information: → [Function Scenes, Page 102](#).

<ul style="list-style-type: none"> Configuration + Device settings + Manual operation + Safety/Weather alarms + Logic/Threshold + Switch Actuator template + Shutter Actuator template - Shutter Actuator A+B: <ul style="list-style-type: none"> Shutter Actuator functions Basic settings Drive Blind/Shutter Status Messages <li style="background-color: #e0e0e0; padding: 2px;">Scene assignments + Shutter Actuator C+D: + Shutter Actuator E+F: + Shutter Actuator G+H: + Shutter Actuator I+J: + Shutter Actuator K+L: + Shutter Actuator M+N: 	<h4 style="margin: 0;">Scene assignments</h4> <hr/> <p>Parameter setting <input type="radio"/> Apply from template <input checked="" type="radio"/> Individual</p> <hr/> <p>Overwrite Scenes on download <input checked="" type="checkbox"/></p> <table border="1" style="width: 100%; border-collapse: collapse;"> <thead> <tr> <th style="width: 10%;">Scene assignment</th> <th style="width: 5%;">Enable</th> <th style="width: 10%;">Scene number</th> <th style="width: 15%;">Delay</th> <th style="width: 10%;">Position height</th> <th style="width: 10%;">Position slat</th> </tr> </thead> <tbody> <tr> <td>1</td> <td style="text-align: center;"><input checked="" type="checkbox"/></td> <td style="text-align: center;">1</td> <td style="text-align: center;">00:00:00</td> <td style="text-align: center;">50 %</td> <td style="text-align: center;">50 %</td> </tr> <tr><td>2</td><td style="text-align: center;"><input type="checkbox"/></td><td></td><td></td><td></td><td></td></tr> <tr><td>3</td><td style="text-align: center;"><input type="checkbox"/></td><td></td><td></td><td></td><td></td></tr> <tr><td>4</td><td style="text-align: center;"><input type="checkbox"/></td><td></td><td></td><td></td><td></td></tr> <tr><td>5</td><td style="text-align: center;"><input type="checkbox"/></td><td></td><td></td><td></td><td></td></tr> <tr><td>6</td><td style="text-align: center;"><input type="checkbox"/></td><td></td><td></td><td></td><td></td></tr> <tr><td>7</td><td style="text-align: center;"><input type="checkbox"/></td><td></td><td></td><td></td><td></td></tr> <tr><td>8</td><td style="text-align: center;"><input type="checkbox"/></td><td></td><td></td><td></td><td></td></tr> <tr><td>9</td><td style="text-align: center;"><input type="checkbox"/></td><td></td><td></td><td></td><td></td></tr> <tr><td>10</td><td style="text-align: center;"><input type="checkbox"/></td><td></td><td></td><td></td><td></td></tr> <tr><td>11</td><td style="text-align: center;"><input type="checkbox"/></td><td></td><td></td><td></td><td></td></tr> <tr><td>12</td><td style="text-align: center;"><input type="checkbox"/></td><td></td><td></td><td></td><td></td></tr> <tr><td>13</td><td style="text-align: center;"><input type="checkbox"/></td><td></td><td></td><td></td><td></td></tr> <tr><td>14</td><td style="text-align: center;"><input type="checkbox"/></td><td></td><td></td><td></td><td></td></tr> <tr><td>15</td><td style="text-align: center;"><input type="checkbox"/></td><td></td><td></td><td></td><td></td></tr> <tr><td>16</td><td style="text-align: center;"><input type="checkbox"/></td><td></td><td></td><td></td><td></td></tr> </tbody> </table> <div style="border: 1px solid #ccc; padding: 5px; margin-top: 5px;"> <p>i Position height (0 % = top; 100 % = bottom)</p> </div> <div style="border: 1px solid #ccc; padding: 5px; margin-top: 5px;"> <p>i Position slat (0 % = open; 100 % = closed)</p> </div> <p>Recall Scene 1 also via 1-bit Group Object <input type="checkbox"/></p>	Scene assignment	Enable	Scene number	Delay	Position height	Position slat	1	<input checked="" type="checkbox"/>	1	00:00:00	50 %	50 %	2	<input type="checkbox"/>					3	<input type="checkbox"/>					4	<input type="checkbox"/>					5	<input type="checkbox"/>					6	<input type="checkbox"/>					7	<input type="checkbox"/>					8	<input type="checkbox"/>					9	<input type="checkbox"/>					10	<input type="checkbox"/>					11	<input type="checkbox"/>					12	<input type="checkbox"/>					13	<input type="checkbox"/>					14	<input type="checkbox"/>					15	<input type="checkbox"/>					16	<input type="checkbox"/>				
Scene assignment	Enable	Scene number	Delay	Position height	Position slat																																																																																																		
1	<input checked="" type="checkbox"/>	1	00:00:00	50 %	50 %																																																																																																		
2	<input type="checkbox"/>																																																																																																						
3	<input type="checkbox"/>																																																																																																						
4	<input type="checkbox"/>																																																																																																						
5	<input type="checkbox"/>																																																																																																						
6	<input type="checkbox"/>																																																																																																						
7	<input type="checkbox"/>																																																																																																						
8	<input type="checkbox"/>																																																																																																						
9	<input type="checkbox"/>																																																																																																						
10	<input type="checkbox"/>																																																																																																						
11	<input type="checkbox"/>																																																																																																						
12	<input type="checkbox"/>																																																																																																						
13	<input type="checkbox"/>																																																																																																						
14	<input type="checkbox"/>																																																																																																						
15	<input type="checkbox"/>																																																																																																						
16	<input type="checkbox"/>																																																																																																						

Fig. 48: Parameter window Scene assignments

This parameter window includes the following parameters:

- [Parameter setting](#), Page 196
- [Overwrite Scenes on download](#), Page 209
- [Enable Scene assignment x \[Shutter Actuator\]](#), Page 211
 - [Scene number](#), Page 210
 - [Delay](#), Page 233
 - [Position height \(0 % = top; 100 % = bottom\)](#), Page 197
 - [Position slat \(0 % = open; 100 % = closed\)](#), Page 197
 - [Recall Scene x also via 1-bit Group Object](#), Page 155

Prerequisites for visibility

- Parameter window [Configuration](#)
 - Parameter [Enable output X + Y](#) \ Option *Yes*
 - Parameter [Application](#) \ Option *Shutter Actuator*
- Parameter window [Shutter Actuator X+Y](#) \ Parameter window [Shutter Actuator functions](#) \ Parameter [Enable function Scenes \[Shutter Actuator\]](#) \ Option *Yes*
- The parameter window is in the parameter window [Shutter Actuator X+Y](#).

7.2.9 Parameter windows Switch Actuator X

The functions can be set individually for each Switch Actuator output in the subordinate parameter windows.

Note

If several Switch Actuator outputs are to be set to the same values, parameterization can be performed in the parameter window [Switch Actuator template](#).

Note

The layout in the parameter window is identical for all outputs. The settings are explained in the following based on examples.

Prerequisites for visibility

- Parameter window [Configuration](#) \ Parameter [Enable output X + Y](#) \ Option *Yes*
- Parameter window [Shutter Actuator X+Y](#) \ Parameter window [Shutter Actuator functions](#) \ Parameter [Application](#) \ Option *Switch Actuator*

7.2.9.1 Parameter windows Functions Switch Actuator

The following settings can be made in this parameter window:

- Select application
- Enable functions
- Connect output to the functions *Logic* and *Threshold*

Configuration	Switch Actuator functions
+ Device settings	Description <input type="text"/>
+ Manual operation	Enable function Safety <input type="checkbox"/>
+ Safety/Weather alarms	Enable function Time No ▼
+ Logic/Threshold	Enable function Scenes <input type="checkbox"/>
+ Switch Actuator template	Enable function Load shedding <input type="checkbox"/>
+ Shutter Actuator template	Output reacts to No Logic/Threshold function ▼
- Switch Actuator A:	i Enable the function Logic/Threshold in the parameter window Logic/Threshold.
Switch Actuator functions	

Fig. 49: Parameter window Functions

This parameter window includes the following parameters:

- [Description, Page 168](#)
- [Enable function Safety, Page 178](#)
- [Enable function Time, Page 180](#)
- [Enable function Scenes \[Switch Actuator\], Page 179](#)
- [Enable function Load shedding, Page 178](#)
- [Output reacts to, Page 157](#)
 - [Reaction on result "0" \[Switch Actuator\], Page 223](#)
 - [Reaction on result "1" \[Switch Actuator\], Page 225](#)

Prerequisites for visibility

- Parameter window *Configuration*
 - Parameter *Enable output X + Y* \ Option *Yes*
 - Parameter *Application* \ Option *Switch Actuator*
- The parameter window is in the parameter window *Switch Actuator X*.

7.2.9.2 Parameter windows Basic settings [Switch Actuator]

Note

If several Switch Actuator outputs are to be set to the same values, parameterization can be performed in the parameter window [Switch Actuator template](#).

The following settings can be made in this parameter window:

- Reaction of output (normally closed/normally opened contact)
- Connect output to the central Group Object [Switch](#)
- Enable and configure status information
- Configure reaction on bus voltage failure, after bus voltage recovery and after download

Configuration	Basic settings
+ Device settings	Parameter setting <input type="radio"/> Apply from template <input checked="" type="radio"/> Individual
+ Manual operation	Reaction of output <input type="radio"/> NC contact <input checked="" type="radio"/> NO contact
+ Safety/Weather alarms	Feedback of contact position via Group Object "Status Switch" <input checked="" type="checkbox"/>
+ Logic/Threshold	Value of Group Object "Status Switch" <input checked="" type="radio"/> 1: closed, 0: open <input type="radio"/> 0: closed, 1: open
+ Switch Actuator template	Send value of Group Object "Status Switch" <input type="text" value="On change or on request"/>
+ Shutter Actuator template	Enable Group Objects "Status byte" <input type="text" value="No"/>
- Switch Actuator A:	Switching reaction on bus voltage failure <input type="text" value="Contact unchanged"/>
Switch Actuator functions	Reaction after bus voltage recovery <input type="text" value="Calculate contact position"/>
Basic settings	Reaction after ETS download <input type="text" value="Switching only if safety function active"/>
+ Switch Actuator B:	Safety functions are taken into account.
+ Shutter Actuator C+D:	

Fig. 50: Parameter window Basic settings

This parameter window includes the following parameters:

- [Parameter setting](#), Page 196
 - [Reaction of output](#), Page 228
 - [Switch output reacts to central Switch Group Object](#), Page 199
 - [Feedback of contact position via Group Object "Status Switch"](#), Page 199
 - [Value of Group Object "Status Switch"](#), Page 239
 - [Send value of Group Object "Status Switch"](#), Page 239
 - [Enable Group Objects "Status byte" \[Switch Actuator\]](#), Page 189
 - [Send value of Group Objects "Status byte" \[Switch Actuator\]](#), Page 244
- [Switching reaction on bus voltage failure](#), Page 200
- [Reaction after bus voltage recovery \[Switch Actuator\]](#), Page 230
- [Reaction after ETS download \[Switch Actuator\]](#), Page 231

Prerequisites for visibility

- Parameter window [Configuration](#)
 - Parameter [Enable output X + Y](#) \ Option *Yes*
 - Parameter [Application](#) \ Option *Switch Actuator*
- The parameter window is in the parameter window [Switch Actuator X](#).

7.2.9.3

Parameter windows Safety

Note

If several Switch Actuator outputs are to be set to the same values, parameterization can be performed in the parameter window [Switch Actuator template](#).

The following settings can be made in this parameter window:

- Parameterize reaction to safety priorities, forced operation and block

The order of priority of safety functions is predefined and cannot be changed:

- Safety priority 1
- forced operation
- Safety priority 2
- Safety priority 3
- Block

More information: → [Switch Actuator safety functions, Page 91](#).

Configuration	Safety
+ Device settings	Parameter setting <input type="radio"/> Apply from template <input checked="" type="radio"/> Individual
+ Manual operation	i The Group Objects "Safety priority 1-3" are enabled in the parameter window "Safety/Weather alarms". The order specifies the priority of the safety functions.
+ Safety/Weather alarms	Forced operation (1 bit/2 bit) <input type="text" value="Deactivated"/>
+ Logic/Threshold	Switching reaction on block <input type="text" value="No reaction/deactivated"/>
+ Switch Actuator template	Switching reaction on cancellation of block, forced operation and safety priority <input type="text" value="No reaction"/>
+ Shutter Actuator template	
- Switch Actuator A:	
Switch Actuator functions	
Basic settings	
Safety	

Fig. 51: Parameter window Safety

This parameter window includes the following parameters:

- [Parameter setting, Page 196](#)
 - [Switching reaction on safety priority x, Page 202](#)
 - [Forced operation \(1 bit / 2 bit\) \[Switch Actuator\], Page 250](#)
 - [Switching reaction on forced operation, Page 204](#)
 - [Switching reaction on block, Page 203](#)
 - [Switching reaction on cancellation of block, forced operation and safety priority, Page 201](#)

Prerequisites for visibility

- Parameter window [Configuration](#)
 - Parameter [Enable output X + Y](#) \ Option *Yes*
 - Parameter [Application](#) \ Option *Switch Actuator*
- Parameter window [Switch Actuator X](#) \ Parameter window [Functions Switch Actuator](#) \ Parameter [Enable function Safety](#) \ Option *Yes*
- The parameter window is in the parameter window [Switch Actuator X](#).

7.2.9.4 Parameter windows Load shedding

Note

If several Switch Actuator outputs are to be set to the same values, parameterization can be performed in the parameter window [Switch Actuator template](#).

The following settings can be made in this parameter window:

- Parameterize function *Load shedding*

More information: → [Function Load shedding, Page 95](#).

Configuration	Load shedding
+ Device settings	Parameter setting <input type="radio"/> Apply from template <input checked="" type="radio"/> Individual
+ Manual operation	Load shedding stage <input type="text" value="1"/>
+ Safety/Weather alarms	Change load shedding stage via Group Object <input type="checkbox"/>
+ Logic/Threshold	Change load shedding stage via i-bus® Tool <input type="checkbox"/>
+ Switch Actuator template	Switching reaction on active load shedding stage <input checked="" type="radio"/> Off <input type="radio"/> On
+ Shutter Actuator template	Switching reaction on revoke of load shedding stage <input type="text" value="No reaction"/>
- Switch Actuator A:	Enable Group Object "Status Load shedding" <input type="checkbox"/>
Switch Actuator functions	
Basic settings	
Load shedding	

Fig. 52: Parameter window Load shedding

This parameter window includes the following parameters:

- [Parameter setting, Page 196](#)
 - [Load shedding stage, Page 191](#)
 - [Change load shedding stage via Group Object, Page 192](#)
 - [Overwrite load shedding stage at download, Page 191](#)
 - [Change load shedding stage via i-bus® Tool, Page 192](#)
 - [Switching reaction on active load shedding stage, Page 200](#)
 - [Switching reaction on revoke of load shedding stage, Page 201](#)
 - [Enable group object "Status Load shedding", Page 185](#)
 - [Send value of Group Object "Status Load shedding", Page 238](#)

Note

The interface to i-bus® Tool is available from the following software versions:

- Application from V1.2
- Firmware from V0.2.0

Prerequisites for visibility

- Parameter window [Configuration](#)
 - Parameter [Enable output X + Y](#) \ Option Yes
 - Parameter [Application](#) \ Option [Switch Actuator](#)
- Parameter window [Device settings](#) \ Parameter [Enable central Group Object "Receive load shedding stage"](#) \ Option Yes
- Parameter window [Switch Actuator X](#) \ Parameter window [Functions Switch Actuator](#) \ Parameter [Enable function Load shedding](#) \ Option Yes
- The parameter window is in the parameter window [Switch Actuator X](#).

7.2.9.5 Parameter windows Staircase lighting

Note

If several Switch Actuator outputs are to be set to the same values, parameterization can be performed in the parameter window [Switch Actuator template](#).

The following settings can be made in this parameter window:

- Parameterize function *Staircase lighting*

More information: → [Function Staircase lighting, Page 104](#).

Note

If a delay is used for Scene recall (→ parameter *Delay*), the output does not react to the functions *Staircase lighting* and *Delay for switching on and off* → [Function diagram Switch Actuator, Page 87](#).

Configuration	Staircase lighting	
+ Device settings	Parameter setting	<input type="radio"/> Apply from template <input checked="" type="radio"/> Individual
+ Manual operation	Staircase lighting time	<input type="text" value="00:05:00"/> hh:mm:ss
+ Safety/Weather alarms	Staircase lighting time can be started again	<input checked="" type="checkbox"/>
+ Logic/Threshold	Staircase lighting time extendable (pumping)	No, can only be started again ▼
+ Switch Actuator template	Switching reaction of staircase lighting on telegram value 0/1	On with "1" and off with "0" ▼
+ Shutter Actuator template	Warning before switching off the staircase lighting	No ▼
- Switch Actuator A:	Block staircase lighting via Group Object	<input type="checkbox"/>
Switch Actuator functions	Change staircase lighting time via Group Object	<input type="checkbox"/>
Basic settings	Change staircase lighting time via i-bus® Tool	<input type="checkbox"/>
Staircase lighting	Restart staircase lighting time after permanent on	<input type="checkbox"/>
+ Switch Actuator B:		

Fig. 53: Parameter window Staircase lighting

This parameter window includes the following parameters:

- [Parameter setting, Page 196](#)
- [Staircase lighting time, Page 217](#)
- [Staircase lighting time can be started again, Page 218](#)
 - [Staircase lighting time extendable \(pumping\), Page 220](#)
- [Switching reaction of staircase lighting on telegram value 0/1, Page 216](#)
- [Warning before switching off the staircase lighting, Page 236](#)
 - [Number of Off/On changes, Page 154](#)
 - [Warning time, Page 236](#)
- [Block staircase lighting via Group Object, Page 216](#)
 - [Block staircase lighting after bus voltage recovery, Page 215](#)
- [Change staircase lighting time via Group Object, Page 219](#)
 - [Overwrite staircase lighting time on download, Page 217](#)
- [Change staircase lighting time via i-bus® Tool, Page 219](#)
- [Restart staircase lighting time after permanent on, Page 218](#)

Prerequisites for visibility

- Parameter window [Configuration](#)
 - Parameter [Enable output X + Y](#) \ Option *Yes*
 - Parameter [Application](#) \ Option *Switch Actuator*
- Parameter window [Switch Actuator X](#) \ Parameter window [Functions Switch Actuator](#) \ Parameter [Enable function Time](#) \ Option *Staircase lighting*
- The parameter window is in the parameter window [Switch Actuator X](#).

7.2.9.6 Parameter windows Delay for switching on and off

Note

If several Switch Actuator outputs are to be set to the same values, parameterization can be performed in the parameter window [Switch Actuator template](#).

The following settings can be made in this parameter window:

- Parameterize function *Delay for switching on and off*

More information: → [Function Delay for switching on and off, Page 106](#).

Note

If a delay is used for Scene recall (→ parameter *Delay*), the output does not react to the functions *Staircase lighting* and *Delay for switching on and off* → [Function diagram Switch Actuator, Page 87](#).

Configuration	Delay for switching on and off
+ Device settings	Parameter setting <input type="radio"/> Apply from template <input checked="" type="radio"/> Individual
+ Manual operation	Delay for switching on <input type="text" value="00:00:00"/> hh:mm:ss
+ Safety/Weather alarms	Delay for switching off <input type="text" value="00:00:00"/> hh:mm:ss
+ Logic/Threshold	Block delay for switching on and off via Group Object <input type="checkbox"/>
+ Switch Actuator template	
+ Shutter Actuator template	
- Switch Actuator A:	
Switch Actuator functions	
Basic settings	
Delay for switching on and off	

Fig. 54: Parameter window Delay for switching on and off

This parameter window includes the following parameters:

- [Parameter setting, Page 196](#)
 - [Delay for switching on, Page 173](#)
 - [Delay for switching off, Page 159](#)
 - [Block delay for switching on and off via Group Object, Page 171](#)
 - [Block delay for switching on and off after bus voltage recovery, Page 171](#)

Prerequisites for visibility

- Parameter window [Configuration](#)
 - Parameter [Enable output X + Y](#) \ Option Yes
 - Parameter [Application](#) \ Option *Switch Actuator*
- Parameter window [Switch Actuator X](#) \ Parameter window [Functions Switch Actuator](#) \ Parameter [Enable function Time](#) \ Option *Delay for switching on and off*
- The parameter window is in the parameter window [Switch Actuator X](#).

7.2.9.7 Parameter windows Flashing

Note

If several Switch Actuator outputs are to be set to the same values, parameterization can be performed in the parameter window [Switch Actuator template](#).

The following settings can be made in this parameter window:

- Parameterize function *Flashing*

More information: → [Function Flashing, Page 107](#).

Note

Each relay can perform only a limited number of switching operations per minute → Technical data. A large number of switching operations per minute can delay switching.

Note

If the function *Flashing* is used:

- Pay attention to the service life of the lighting equipment.
- Take into account the service life of the switching contacts → Technical data.

Configuration	Flashing
+ Device settings	Parameter setting <input type="radio"/> Apply from template <input checked="" type="radio"/> Individual
+ Manual operation	Flashing if Group Object "Flashing" is <input type="text" value="On (1) or off (0)"/>
+ Safety/Weather alarms	Time for on <input type="text" value="00:00:05"/> hh:mm:ss
+ Logic/Threshold	Time for off <input type="text" value="00:00:05"/> hh:mm:ss
+ Switch Actuator template	Number of flashing cycles <input type="text" value="5"/>
+ Shutter Actuator template	Reaction after flashing <input type="text" value="Refreshed KNX state"/>
- Switch Actuator A:	Note Observe the contact life span and switching cycles per minute. For more information, see product manual.
Switch Actuator functions	
Basic settings	
Flashing	

Fig. 55: Parameter window Flashing

This parameter window includes the following parameters:

- [Parameter setting, Page 196](#)
 - [Flashing if Group Object "Flashing" is, Page 169](#)
 - [Time for on, Page 246](#)
 - [Time for off, Page 245](#)
 - [Number of flashing cycles, Page 154](#)
 - [Reaction after flashing, Page 229](#)

Prerequisites for visibility

- Parameter window [Configuration](#)
 - Parameter [Enable output X + Y](#) \ Option *Yes*
 - Parameter [Application](#) \ Option *Switch Actuator*
- Parameter window [Switch Actuator X](#) \ Parameter window [Functions Switch Actuator](#) \ Parameter [Enable function Time](#) \ Option *Flashing*
- The parameter window is in the parameter window [Switch Actuator X](#).

7.2.9.8 Parameter windows Scene assignments [Switch Actuator]

Note

If several Switch Actuator outputs are to be set to the same values, parameterization can be performed in the parameter window *Switch Actuator template*.

The following settings can be made in this parameter window:

- Enable Scene assignments
- Create Scenes

More information: → [Function Scenes, Page 102](#).

<p>Configuration</p> <ul style="list-style-type: none"> + Device settings + Manual operation + Safety/Weather alarms + Logic/Threshold + Switch Actuator template + Shutter Actuator template - Switch Actuator A: <ul style="list-style-type: none"> Switch Actuator functions Basic settings <li style="background-color: #e0e0e0;">Scene assignments + Switch Actuator B: + Shutter Actuator C+D: + Shutter Actuator E+F: + Shutter Actuator G+H: + Shutter Actuator I+J: + Shutter Actuator K+L: + Shutter Actuator M+N: 	<p>Scene assignments</p> <hr/> <p>Parameter setting <input type="radio"/> Apply from template <input checked="" type="radio"/> Individual</p> <hr/> <p>Overwrite Scenes on download <input checked="" type="checkbox"/></p> <table border="1" style="width: 100%; border-collapse: collapse;"> <thead> <tr> <th style="width: 15%;">Scene assignment</th> <th style="width: 10%;">Enable</th> <th style="width: 10%;">Scene number</th> <th style="width: 20%;">Delay</th> <th style="width: 45%;">Reaction on Scene recall</th> </tr> </thead> <tbody> <tr> <td>1</td> <td style="text-align: center;"><input checked="" type="checkbox"/></td> <td style="text-align: center;">1</td> <td style="text-align: center;">00:00:00 <small>hh:mm:ss</small></td> <td style="text-align: center;"><input checked="" type="radio"/> On <input type="radio"/> Off</td> </tr> <tr><td>2</td><td style="text-align: center;"><input type="checkbox"/></td><td></td><td></td><td></td></tr> <tr><td>3</td><td style="text-align: center;"><input type="checkbox"/></td><td></td><td></td><td></td></tr> <tr><td>4</td><td style="text-align: center;"><input type="checkbox"/></td><td></td><td></td><td></td></tr> <tr><td>5</td><td style="text-align: center;"><input type="checkbox"/></td><td></td><td></td><td></td></tr> <tr><td>6</td><td style="text-align: center;"><input type="checkbox"/></td><td></td><td></td><td></td></tr> <tr><td>7</td><td style="text-align: center;"><input type="checkbox"/></td><td></td><td></td><td></td></tr> <tr><td>8</td><td style="text-align: center;"><input type="checkbox"/></td><td></td><td></td><td></td></tr> <tr><td>9</td><td style="text-align: center;"><input type="checkbox"/></td><td></td><td></td><td></td></tr> <tr><td>10</td><td style="text-align: center;"><input type="checkbox"/></td><td></td><td></td><td></td></tr> <tr><td>11</td><td style="text-align: center;"><input type="checkbox"/></td><td></td><td></td><td></td></tr> <tr><td>12</td><td style="text-align: center;"><input type="checkbox"/></td><td></td><td></td><td></td></tr> <tr><td>13</td><td style="text-align: center;"><input type="checkbox"/></td><td></td><td></td><td></td></tr> <tr><td>14</td><td style="text-align: center;"><input type="checkbox"/></td><td></td><td></td><td></td></tr> <tr><td>15</td><td style="text-align: center;"><input type="checkbox"/></td><td></td><td></td><td></td></tr> <tr><td>16</td><td style="text-align: center;"><input type="checkbox"/></td><td></td><td></td><td></td></tr> </tbody> </table> <div style="border: 1px solid #ccc; padding: 5px; margin-top: 10px;"> <p>i If delay not equal to 0, there is no staircase lighting and no delay for switching on and off.</p> </div> <p>Recall Scene 1 also via 1-bit Group Object <input type="checkbox"/></p>	Scene assignment	Enable	Scene number	Delay	Reaction on Scene recall	1	<input checked="" type="checkbox"/>	1	00:00:00 <small>hh:mm:ss</small>	<input checked="" type="radio"/> On <input type="radio"/> Off	2	<input type="checkbox"/>				3	<input type="checkbox"/>				4	<input type="checkbox"/>				5	<input type="checkbox"/>				6	<input type="checkbox"/>				7	<input type="checkbox"/>				8	<input type="checkbox"/>				9	<input type="checkbox"/>				10	<input type="checkbox"/>				11	<input type="checkbox"/>				12	<input type="checkbox"/>				13	<input type="checkbox"/>				14	<input type="checkbox"/>				15	<input type="checkbox"/>				16	<input type="checkbox"/>			
Scene assignment	Enable	Scene number	Delay	Reaction on Scene recall																																																																																		
1	<input checked="" type="checkbox"/>	1	00:00:00 <small>hh:mm:ss</small>	<input checked="" type="radio"/> On <input type="radio"/> Off																																																																																		
2	<input type="checkbox"/>																																																																																					
3	<input type="checkbox"/>																																																																																					
4	<input type="checkbox"/>																																																																																					
5	<input type="checkbox"/>																																																																																					
6	<input type="checkbox"/>																																																																																					
7	<input type="checkbox"/>																																																																																					
8	<input type="checkbox"/>																																																																																					
9	<input type="checkbox"/>																																																																																					
10	<input type="checkbox"/>																																																																																					
11	<input type="checkbox"/>																																																																																					
12	<input type="checkbox"/>																																																																																					
13	<input type="checkbox"/>																																																																																					
14	<input type="checkbox"/>																																																																																					
15	<input type="checkbox"/>																																																																																					
16	<input type="checkbox"/>																																																																																					

Fig. 56: Parameter window Scene assignment

This parameter window includes the following parameters:

- [Parameter setting, Page 196](#)
- [Overwrite Scenes on download, Page 209](#)
- [Enable Scene assignment x \[Switch Actuator\], Page 211](#)
 - [Scene number, Page 210](#)
 - [Delay, Page 233](#)
 - [Reaction on Scene recall, Page 228](#)
 - [Recall Scene x also via 1-bit Group Object, Page 155](#)

Prerequisites for visibility

- Parameter window [Configuration](#)
 - Parameter [Enable output X + Y](#) \ Option *Yes*
 - Parameter [Application](#) \ Option *Switch Actuator*
- Parameter window [Switch Actuator X](#) \ Parameter window [Functions Switch Actuator](#) \ Parameter [Enable function Scenes \[Switch Actuator\]](#) \ Option *Yes*
- The parameter window is in the parameter window [Switch Actuator X](#).

7.3 Overview of parameters

- [Application, Page 155](#)
- [Automatic reactivation of Automatic sun protection, Page 160](#)
- [Automatic reset after, Page 160](#)
- [Automatic reset from manual operation to KNX operation, Page 161](#)
- [Blind/Shutter reaction on block, Page 165](#)
- [Blind/Shutter reaction on bus voltage failure, Page 161](#)
- [Blind/Shutter reaction on cancellation of weather alarm, block and forced operation, Page 164](#)
- [Blind/Shutter reaction on frost alarm, Page 162](#)
- [Blind/Shutter reaction on rain alarm, Page 163](#)
- [Blind/Shutter reaction on wind alarm, Page 166](#)
- [Block delay for switching on and off after bus voltage recovery, Page 171](#)
- [Block delay for switching on and off via Group Object, Page 171](#)
- [Block staircase lighting after bus voltage recovery, Page 215](#)
- [Block staircase lighting via Group Object, Page 216](#)
- [Change load shedding stage via Group Object, Page 192](#)
- [Change load shedding stage via i-bus® Tool, Page 192](#)
- [Change staircase lighting time via Group Object, Page 219](#)
- [Change staircase lighting time via i-bus® Tool, Page 219](#)
- [Change thresholds via Group Objects, Page 205](#)
- [Change thresholds via i-bus® Tool, Page 205](#)
- [Coasting delay, Page 159](#)
- [Cyclical monitoring, Page 250](#)
- [Data point type of Group Object "Threshold input", Page 169](#)
- [Deactivate Automatic sun protection on cancellation of weather alarms, block and forced operation, Page 207](#)
- [Deactivation of Automatic sun protection, Page 171](#)
- [Dead time Blind/Shutter adjustment on change of direction, Page 212](#)
- [Dead time Blind/Shutter movement from lower end position \(100 %\), Page 212](#)
- [Dead time slat adjustment on change of direction, Page 214](#)
- [Dead time slat movement \(from 100 % closed\), Page 213](#)
- [Delay for sun = 0, Page 234](#)
- [Delay for sun = 1, Page 234](#)
- [Delay for switching off, Page 159](#)
- [Delay for switching on, Page 173](#)
- [Delay time for drive, Page 235](#)
- [Delay, Page 233](#)
- [Description, Page 168](#)
- [Determine slat adjustment time, Page 190](#)
- [Disconnect output from power after, Page 158](#)
- [Duration for tensioning, Page 170](#)
- [Duration of slat adjustment/step, Page 173](#)
- [Enable central Group Object "Receive load shedding stage", Page 247](#)
- [Enable central Group Object "Scene 1 ... 64", Page 248](#)
- [Enable central Group Object "Switch", Page 248](#)
- [Enable central Group Objects "Shutter", Page 247](#)
- [Enable function Automatic sun protection, Page 179](#)
- [Enable function Load shedding, Page 178](#)
- [Enable function Safety, Page 178](#)
- [Enable function Safety/Weather alarms, Page 178](#)
- [Enable function Scenes \[Shutter Actuator\], Page 179](#)
- [Enable function Scenes \[Switch Actuator\], Page 179](#)
- [Enable function Time, Page 180](#)
- [Enable Group Object "Block automatic sun protection", Page 183](#)
- [Enable Group Object "Block direct operation", Page 181](#)
- [Enable Group Object "Frost alarm", Page 181](#)
- [Enable Group Object "In operation", Page 182](#)

- [Enable Group Object "Rain alarm", Page 182](#)
- [Enable Group Object "Request status values", Page 186](#)
- [Enable Group Object "Safety priority x", Page 183](#)
- [Enable Group Object "Status Automatic sun protection", Page 185](#)
- [Enable group object "Status Load shedding", Page 185](#)
- [Enable Group Object "Status Operability", Page 184](#)
- [Enable Group Object "Status Result", Page 184](#)
- [Enable Group Object "Trigger reference movement", Page 182](#)
- [Enable Group Object "Wind alarm x", Page 186](#)
- [Enable Group Objects "Move to position Height/Slat", Page 186](#)
- [Enable Group Objects "Status byte" \[Shutter Actuator\], Page 188](#)
- [Enable Group Objects "Status byte" \[Switch Actuator\], Page 189](#)
- [Enable Group Objects "Status Height/Slat", Page 188](#)
- [Enable Group Objects "Status Result" and "Status Input value between thresholds", Page 187](#)
- [Enable Group Objects "Status Upper/Lower end position", Page 187](#)
- [Enable Logic/Threshold x-y, Page 193](#)
- [Enable manual operation, Page 193](#)
- [Enable output X + Y, Page 159](#)
- [Enable Scene assignment x \[Shutter Actuator\], Page 211](#)
- [Enable Scene assignment x \[Switch Actuator\], Page 211](#)
- [Enable Time Group Objects for setting of device time, Page 189](#)
- [Feedback of contact position via Group Object "Status Switch", Page 199](#)
- [Flashing if Group Object "Flashing" is, Page 169](#)
- [Forced operation \(1 bit / 2 bit\) \[Shutter Actuator\], Page 249](#)
- [Forced operation \(1 bit / 2 bit\) \[Switch Actuator\], Page 250](#)
- [Function of the logic gate, Page 176](#)
- [GATE blocks if Group Object "Connection A" equals, Page 212](#)
- [i-bus® Tool access, Page 248](#)
- [In period \(0 = deactivated\), Page 181](#)
- [Invert result, Page 174](#)
- [Limit step commands to number of slat adjustments, Page 208](#)
- [Limit travel range via Group Object, Page 175](#)
- [Load shedding stage, Page 191](#)
- [Lower limit \(0 % = top; 100 % = bottom\), Page 221](#)
- [Lower limit valid for Automatic sun protection commands, Page 221](#)
- [Lower limit valid for direct commands, Page 221](#)
- [Lower threshold, Page 222](#)
- [Maximum number of sent telegrams, Page 193](#)
- [Min. duration of the overshoot, Page 194](#)
- [Min. duration of the undershoot, Page 194](#)
- [Minimum dwell time between the thresholds, Page 195](#)
- [Minimum run time for drive, Page 194](#)
- [Monitor range between thresholds, Page 167](#)
- [Move to position, Page 197](#)
- [Number of flashing cycles, Page 154](#)
- [Number of Off/On changes, Page 154](#)
- [Number of slat adjustments/steps \(from 0 % = open to 100 % = closed\), Page 155](#)
- [Operating mode, Page 168](#)
- [Order of priority for weather alarms, Page 198](#)
- [Order of priority of weather alarm, block and forced operation, Page 198](#)
- [Output reacts to central shutter Group Objects, Page 158](#)
- [Output reacts to wind alarm x, Page 157](#)
- [Output reacts to, Page 157](#)
- [Overwrite load shedding stage at download, Page 191](#)
- [Overwrite Scenes on download, Page 209](#)
- [Overwrite staircase lighting time on download, Page 217](#)
- [Overwrite thresholds on download, Page 204](#)
- [Parameter setting, Page 196](#)

- [Position after reference movement, Page 198](#)
- [Position height \(0 % = top; 100 % = bottom\), Page 197](#)
- [Position slat \(0 % = open; 100 % = closed\), Page 197](#)
- [Reaction after bus voltage recovery \[Shutter Actuator\], Page 229](#)
- [Reaction after bus voltage recovery \[Switch Actuator\], Page 230](#)
- [Reaction after ETS download \[Shutter Actuator\], Page 230](#)
- [Reaction after ETS download \[Switch Actuator\], Page 231](#)
- [Reaction after flashing, Page 229](#)
- [Reaction of output, Page 228](#)
- [Reaction on result "0" \[Shutter Actuator\], Page 222](#)
- [Reaction on result "0" \[Switch Actuator\], Page 223](#)
- [Reaction on result "1" \[Shutter Actuator\], Page 224](#)
- [Reaction on result "1" \[Switch Actuator\], Page 225](#)
- [Reaction on Scene recall, Page 228](#)
- [Reaction on sun = 0 \(no sun\), Page 225](#)
- [Reaction on sun = 1 \(sun\), Page 226](#)
- [Read Automatic sun protection Group Objects after bus voltage recovery and download, Page 208](#)
- [Read input Group Objects after bus voltage recovery and download, Page 172](#)
- [Read safety Group Objects after bus voltage recovery and download, Page 207](#)
- [Recall Scene x also via 1-bit Group Object, Page 155](#)
- [Request Date/Time via Group Object, Page 170](#)
- [Restart staircase lighting time after permanent on, Page 218](#)
- [Result if lower threshold is dropped below, Page 174](#)
- [Result if upper threshold is exceeded, Page 174](#)
- [Reversing time, Page 220](#)
- [Scene assignment, Page 210](#)
- [Scene number, Page 210](#)
- [Send value of Group Object "Status Automatic sun protection", Page 240](#)
- [Send value of Group Object "Status Load shedding", Page 238](#)
- [Send value of Group Object "Status Operability", Page 237](#)
- [Send value of Group Object "Status Result", Page 237](#)
- [Send value of Group Object "Status Switch", Page 239](#)
- [Send value of Group Objects "Status byte" \[Shutter Actuator\], Page 243](#)
- [Send value of Group Objects "Status byte" \[Switch Actuator\], Page 244](#)
- [Send value of Group Objects "Status Height/Slat", Page 242](#)
- [Send value of Group Objects "Status Upper/Lower end position", Page 241](#)
- [Send values of Group Objects "Status Result" and "Status Input value between thresholds", Page 245](#)
- [Sending and switching delay after bus voltage recovery, Page 206](#)
- [Sending cycle, Page 206](#)
- [Set dead times, Page 214](#)
- [Slat position after reaching lower end position \(100 % = deactivated\), Page 190](#)
- [Staircase lighting time can be started again, Page 218](#)
- [Staircase lighting time extendable \(pumping\), Page 220](#)
- [Staircase lighting time, Page 217](#)
- [Start-up delay, Page 154](#)
- [State after end of manual operation, Page 249](#)
- [Switch output reacts to central Switch Group Object, Page 199](#)
- [Switching reaction of staircase lighting on telegram value 0/1, Page 216](#)
- [Switching reaction on active load shedding stage, Page 200](#)
- [Switching reaction on block, Page 203](#)
- [Switching reaction on bus voltage failure, Page 200](#)
- [Switching reaction on cancellation of block, forced operation and safety priority, Page 201](#)
- [Switching reaction on forced operation, Page 204](#)
- [Switching reaction on revoke of load shedding stage, Page 201](#)
- [Switching reaction on safety priority x, Page 202](#)
- [Tensioning/Slot positioning, Page 209](#)
- [Time for automatic reactivation of Automatic sun protection, Page 246](#)
- [Time for off, Page 245](#)

- *Time for on, Page 246*
- *Total duration for slat turning from 0 % - 100 %, Page 180*
- *Total turning of slats after down movement, Page 235*
- *Travel time down, Page 176*
- *Travel time up, Page 176*
- *Upper limit (0 % = top; 100 % = bottom), Page 195*
- *Upper limit valid for Automatic sun protection commands, Page 196*
- *Upper limit valid for direct commands, Page 195*
- *Upper threshold, Page 196*
- *Value after sending and switching delay has expired, Page 244*
- *Value of Group Object "Connection A" after bus voltage recovery, Page 240*
- *Value of Group Object "Connection B" after bus voltage recovery, Page 241*
- *Value of Group Object "Status Switch", Page 239*
- *Warning before switching off the staircase lighting, Page 236*
- *Warning time, Page 236*

7.4 Parameter descriptions

7.4.1 Start-up delay

This parameter is used to define the duration of the start-up delay.

Option

0... 999 ms

Prerequisites for visibility

- Parameter window [Configuration](#)
 - Parameter [Enable output X + Y](#) \ Option *Yes*
 - Parameter [Application](#) \ Option *Shutter Actuator*
- Parameter window [Shutter Actuator X+Y](#) \ Parameter window [Drive](#)
 - Parameter [Parameter setting](#) \ Option *Individual*
 - Parameter [Delay time for drive](#) \ Option *User-defined*
- The parameter is in the parameter window [Shutter Actuator X+Y](#) \ parameter window [Drive](#).

7.4.2 Number of Off/On changes

This parameter is used to define the number of Off/On changes during the warning time.

Option

1... 2... 5

Prerequisites for visibility

- Parameter window [Configuration](#)
 - Parameter [Enable output X + Y](#) \ Option *Yes*
 - Parameter [Application](#) \ Option *Switch Actuator*
- Parameter window [Switch Actuator X](#) \ Parameter window [Functions Switch Actuator](#) \ Parameter [Enable function Time](#) \ Option *Staircase lighting*
- Parameter window [Switch Actuator X](#) \ Parameter window [Staircase lighting](#)
 - Parameter [Parameter setting](#) \ Option *Individual*
 - Parameter [Warning before switching off the staircase lighting](#) \ Option *Short switching off / Via Group Object and short switching off*
- The parameter is in the parameter window [Switch Actuator X](#) \ parameter window [Staircase lighting](#).

7.4.3 Number of flashing cycles

This parameter is used to define the number of flashing cycles. A flashing cycle consists of one On/Off change.

Option

0... 5... 100

Prerequisites for visibility

- Parameter window [Configuration](#)
 - Parameter [Enable output X + Y](#) \ Option *Yes*
 - Parameter [Application](#) \ Option *Switch Actuator*
- Parameter window [Switch Actuator X](#) \ Parameter window [Functions Switch Actuator](#) \ Parameter [Enable function Time](#) \ Option *Flashing*
- Parameter window [Switch Actuator X](#) \ Parameter window [Flashing](#) \ Parameter [Parameter setting](#) \ Option *Individual*
- The parameter is in the parameter window [Switch Actuator X](#) \ parameter window [Flashing](#).

7.4.4 Number of slat adjustments/steps (from 0 % = open to 100 % = closed)

This parameter is used to define the number of slat adjustments required to adjust the slats from fully open to fully closed.

Option

1 ... 7 ... 60

Prerequisites for visibility

- Parameter window [Configuration](#)
 - Parameter [Enable output X + Y](#) \ Option Yes
 - Parameter [Application](#) \ Option [Shutter Actuator](#)
- Parameter window [Shutter Actuator X+Y](#) \ Parameter window [Shutter Actuator functions](#) \ Parameter [Operating mode](#) \ Option [Blind/Shutter control with slat adjustment](#)
- Parameter window [Shutter Actuator X+Y](#) \ Parameter window [Blind/Shutter](#) \ Parameter [Parameter setting](#) \ Option [Individual](#)
- The parameter is in the parameter window [Shutter Actuator X+Y](#) \ parameter window [Blind/Shutter](#).

7.4.5 Application

This parameter is used to define which application is used for the output pair.

Option

[Shutter Actuator](#)

The following dependent parameter windows are shown:

- [Shutter Actuator X+Y](#)
- [Shutter Actuator functions](#)
- [Basic settings \[Shutter Actuator\]](#)
- [Drive](#)
- [Blind/Shutter](#)
- [status messages](#)

The following dependent Group Objects are displayed:

- [Move Blind/Shutter Up/Down](#)
- [Slat adjustment / Stop Up/Down](#)

[Switch Actuator](#)

The following dependent parameter windows are shown:

- [Switch Actuator X](#)
- [Functions Switch Actuator](#)
- [Basic settings \[Switch Actuator\]](#)

The following dependent Group Objects are displayed:

- [Switch](#)

[Deactivated](#)

The output is deactivated. This option is only available for every second Switch Actuator output (B, D, etc.).

Prerequisites for visibility

- Parameter window [Configuration](#) \ Parameter [Enable output X + Y](#) \ Option Yes
- The parameter is in the parameter window [Configuration](#).

7.4.6 Recall Scene x also via 1-bit Group Object

Note

This parameter is available only for the Scene assignments 1 ... 4.

This parameter is used to define whether it is possible to recall the Scene assignment also via the following Group Objects:

- Configuration as Shutter Actuator:
 - [Recall Scene assignment x](#)
- Configuration as Switch Actuator:
 - [Recall Scene assignment x](#)

Option	
<i>No</i>	It is not possible to recall the Scene assignment via Group Object.
<i>Yes</i>	The following dependent Group Objects are displayed: <ul style="list-style-type: none"> • Recall Scene assignment x • Recall Scene assignment x

Prerequisites for visibility

Configuration as Shutter Actuator

- Parameter window [Configuration](#)
 - Parameter [Enable output X + Y](#) \ Option *Yes*
 - Parameter [Application](#) \ Option *Shutter Actuator*
- Parameter window [Shutter Actuator X+Y](#) \ Parameter window [Shutter Actuator functions](#) \ Parameter [Enable function Scenes \[Shutter Actuator\]](#) \ Option *Yes*
- Parameter window [Shutter Actuator X+Y](#) \ Parameter window [Scene assignments \[Shutter Actuator\]](#)
 - Parameter [Parameter setting](#) \ Option *Individual*
 - Parameter [Enable Scene assignment x \[Shutter Actuator\]](#) \ Option *Yes*
- The parameter is in the parameter window [Shutter Actuator X+Y](#) \ parameter window [Scene assignments \[Shutter Actuator\]](#).

or

Configuration as Switch Actuator

- Parameter window [Configuration](#)
 - Parameter [Enable output X + Y](#) \ Option *Yes*
 - Parameter [Application](#) \ Option *Switch Actuator*
- Parameter window [Switch Actuator X](#) \ Parameter window [Functions Switch Actuator](#) \ Parameter [Enable function Scenes \[Switch Actuator\]](#) \ Option *Yes*
- Parameter window [Switch Actuator X](#) \ Parameter window [Scene assignments \[Switch Actuator\]](#)
 - Parameter [Parameter setting](#) \ Option *Individual*
 - Parameter [Enable Scene assignment x \[Switch Actuator\]](#) \ Option *Yes*
- The parameter is in the parameter window [Switch Actuator X](#) \ parameter window [Scene assignments \[Switch Actuator\]](#).

7.4.7 Output reacts to

This parameter is used to define whether the output reacts to the result of a Logic or Threshold function.

More information → [Function Logic, Page 93](#), → [Function Threshold, Page 94](#).

Option	
<i>No Logic/Threshold function</i>	The output does not react to the result of a <i>Logic</i> or <i>Threshold</i> function.
<i>Logic/Threshold x</i>	The output reacts to the result of the function <i>Logic/Threshold x</i> ($x = 1 \dots 24$). The following dependent parameters are shown: <ul style="list-style-type: none"> • Configuration as Shutter Actuator: <ul style="list-style-type: none"> – Reaction on result "0" [Shutter Actuator] – Reaction on result "1" [Shutter Actuator] • Configuration as Switch Actuator: <ul style="list-style-type: none"> – Reaction on result "0" [Switch Actuator] – Reaction on result "1" [Switch Actuator]

Prerequisites for visibility

- Parameter window [Configuration](#)
 - Parameter [Enable output X + Y](#) \ Option *Yes*
 - Parameter [Application](#) \ Option *Shutter Actuator*
- The parameter is in the parameter window [Shutter Actuator X+Y](#) \ parameter window [Shutter Actuator functions](#).

or

- Parameter window [Configuration](#)
 - Parameter [Enable output X + Y](#) \ Option *Yes*
 - Parameter [Application](#) \ Option *Switch Actuator*
- The parameter is in the parameter window [Switch Actuator X](#) \ parameter window [Functions Switch Actuator](#).

7.4.8 Output reacts to wind alarm x

This parameter is used to define whether the Shutter Actuator output pair reacts to the Group Objects [Wind alarm x](#) ($x = 1, 2, \text{ or } 3$).

If several wind alarms are assigned to an output, they will be linked by a logic OR.

More information: → [Wind alarm, Page 88](#).

Option	
<i>No</i>	The Shutter Actuator output pair does not react to the alarm.
<i>Yes</i>	The following dependent parameters are shown: <ul style="list-style-type: none"> • Blind/Shutter reaction on wind alarm

Prerequisites for visibility

- Parameter window [Configuration](#)
 - Parameter [Enable output X + Y](#) \ Option *Yes*
 - Parameter [Application](#) \ Option *Shutter Actuator*
- Parameter window [Safety/Weather alarms](#) \ Parameter [Enable Group Object "Wind alarm x"](#) \ Option *Yes*
- Parameter window [Shutter Actuator X+Y](#) \ Parameter window [Shutter Actuator functions](#) \ Parameter [Enable function Safety/Weather alarms](#) \ Option *Yes*
- Parameter window [Shutter Actuator X+Y](#) \ Parameter window [Safety/Weather alarms](#) \ Parameter [Parameter setting](#) \ Option *Individual*
- The parameter is in the parameter window [Shutter Actuator X+Y](#) \ parameter window [Safety/Weather alarms](#).

7.4.9 Output reacts to central shutter Group Objects

This parameter is used to define whether the Shutter Actuator output pair can be switched via the central shutter Group Objects.

Option

No

Yes

Prerequisites for visibility

- Parameter window [Configuration](#)
 - Parameter [Enable output X + Y](#) \ Option Yes
 - Parameter [Application](#) \ Option *Shutter Actuator*
- Parameter window [Device settings](#) \ Parameter [Enable central Group Objects "Shutter"](#) \ Option Yes
- Parameter window [Shutter Actuator X+Y](#) \ Parameter window [Basic settings \[Shutter Actuator\]](#) \ Parameter [Parameter setting](#) \ Option *Individual*
- The parameter is in the parameter window [Shutter Actuator X+Y](#) \ parameter window [Basic settings \[Shutter Actuator\]](#).

7.4.10 Disconnect output from power after

This parameter is used to define when the output is deenergized after the upper or lower end position is reached.

Note

The drive deenergizes by means of the integrated limit switches after reaching the upper or lower end position. An overrun time can be set in the parameter [Delay time for drive](#) so that the end position is reliably reached. When the drive is switched off, the voltage remains applied for a short time so as to move the drive to the end position in a defined manner. The position calculated in the device is the basis for determining the end position.

Option

End position, no overrun

End position + 2 % overrun

End position + 5 % overrun

End position + 10 % overrun

End position + 20 % overrun

Total travel time + 10 % overrun

Prerequisites for visibility

- Parameter window [Configuration](#)
 - Parameter [Enable output X + Y](#) \ Option Yes
 - Parameter [Application](#) \ Option *Shutter Actuator*
- Parameter window [Shutter Actuator X+Y](#) \ Parameter window [Drive](#) \ Parameter [Parameter setting](#) \ Option *Individual*
- The parameter is in the parameter window [Shutter Actuator X+Y](#) \ parameter window [Drive](#).

7.4.11 Enable output X + Y

These parameters enable the device outputs in pairs.

Option	
<i>No</i>	The outputs are not enabled.
<i>Yes</i>	The following dependent parameter windows are shown: <ul style="list-style-type: none"> • Shutter Actuator X+Y • Shutter Actuator functions • Basic settings [Shutter Actuator] • Drive • Blind/Shutter • status messages

Prerequisites for visibility

- The parameter is in the parameter window [Configuration](#).

7.4.12 Coasting delay

This parameter is used to define the duration of the coasting delay.

Option	
<i>0... 999 ms</i>	

Prerequisites for visibility

- Parameter window [Configuration](#)
 - Parameter [Enable output X + Y](#) \ Option [Yes](#)
 - Parameter [Application](#) \ Option [Shutter Actuator](#)
- Parameter window [Shutter Actuator X+Y](#) \ Parameter window [Drive](#)
 - Parameter [Parameter setting](#) \ Option [Individual](#)
 - Parameter [Delay time for drive](#) \ Option [User-defined](#)
- The parameter is in the parameter window [Shutter Actuator X+Y](#) \ parameter window [Drive](#).

7.4.13 Delay for switching off

This parameter is used to define the switch-off delay for the output after an Off telegram is received.

More information: → [Function Delay for switching on and off, Page 106](#).

Option	
<i>00:00:00... 18:12:15 hh:mm:ss</i>	

Prerequisites for visibility

- Parameter window [Configuration](#)
 - Parameter [Enable output X + Y](#) \ Option [Yes](#)
 - Parameter [Application](#) \ Option [Switch Actuator](#)
- Parameter window [Switch Actuator X](#) \ Parameter window [Functions Switch Actuator](#) \ Parameter [Enable function Time](#) \ Option [Delay for switching on and off](#)
- Parameter window [Switch Actuator X](#) \ Parameter window [Delay for switching on and off](#) \ Parameter [Parameter setting](#) \ Option [Individual](#)
- The parameter is in the parameter window [Switch Actuator X](#) \ parameter window [Delay for switching on and off](#).

7.4.14 Automatic reset after

This parameter is used to define the time after which the device is automatically reset to the operating state *KNX operation*.

After the *Manual operation* button is pressed, the device remains in the operating state *Manual operation* until the button is pressed again or the set time expires.

Option

00:00:30 ... 00:05:00 ... 18:12:15 hh:mm:ss

Prerequisites for visibility

- Parameter window *Manual operation*
 - Parameter *Enable manual operation* \ Option Yes
 - Parameter *Automatic reset from manual operation to KNX operation* \ Option Yes
- The parameter is in the parameter window *Manual operation*.

7.4.15 Automatic reactivation of Automatic sun protection

This parameter is used to define whether the function *Automatic sun protection* is reactivated after an adjustable time.

i Note

This parameter only has an effect if the function *Automatic sun protection* has been deactivated by the receipt of a direct command.

More information: → [Activation/deactivation of Automatic sun protection, Page 101](#).

Option

<i>No</i>	The function <i>Automatic sun protection</i> is not reactivated automatically.
<i>Yes</i>	The following dependent parameters are shown: <ul style="list-style-type: none"> • <i>Time for automatic reactivation of Automatic sun protection</i>

Prerequisites for visibility

- Parameter window *Configuration*
 - Parameter *Enable output X + Y* \ Option Yes
 - Parameter *Application* \ Option *Shutter Actuator*
- Parameter window *Shutter Actuator X+Y* \ Parameter window *Shutter Actuator functions* \ Parameter *Enable function Automatic sun protection* \ Option Yes
- Parameter window *Shutter Actuator X+Y* \ Parameter window *Automatic sun protection*
 - Parameter *Parameter setting* \ Option *Individual*
 - Parameter *Deactivation of Automatic sun protection* \ Option *Via Group Object or direct command*
- The parameter is in the parameter window *Shutter Actuator X+Y* \ parameter window *Automatic sun protection*.

7.4.16 Automatic reset from manual operation to KNX operation

This parameter is used to define whether the device is reset from the operating state *Manual operation* to the operating state *KNX operation* after an adjustable time.

Option	
<i>No</i>	Automatic reset is deactivated. The operating state can be changed only using the <i>Manual operation</i> button.
<i>Yes</i>	The following dependent parameters are shown: <ul style="list-style-type: none"> • Automatic reset after

Prerequisites for visibility

- Parameter window [Manual operation](#) \ Parameter [Enable manual operation](#) \ Option *Yes*
- The parameter is in the parameter window [Manual operation](#).

7.4.17 Blind/Shutter reaction on bus voltage failure

This parameter is used to define the reaction of the Blind/Shutter on bus voltage failure.

Note

The safety functions have priority over all other functions and priorities.
More information: → [Priorities, Page 281](#).

Option	
<i>No reaction</i>	If the Blind/Shutter is moving, it will continue until reaching the target position. If the Blind/Shutter is at rest, its position will remain unchanged.
<i>Up</i>	Acts like an Up telegram on the Group Object Move Blind/Shutter Up/Down .
<i>Down</i>	Acts like a Down telegram on the Group Object Move Blind/Shutter Up/Down .
<i>Stop</i>	Acts like a Stop telegram on one of the following Group Objects: <ul style="list-style-type: none"> • Stop Up/Down • Slat adjustment / Stop Up/Down

Prerequisites for visibility

- Parameter window [Configuration](#)
 - Parameter [Enable output X + Y](#) \ Option *Yes*
 - Parameter [Application](#) \ Option *Shutter Actuator*
- Parameter window [Shutter Actuator X+Y](#) \ Parameter window [Basic settings \[Shutter Actuator\]](#) \ Parameter [Parameter setting](#) \ Option *Individual*
- The parameter is in the parameter window [Shutter Actuator X+Y](#) \ parameter window [Basic settings \[Shutter Actuator\]](#).

7.4.18 Blind/Shutter reaction on frost alarm

This parameter is used to define the reaction of the Blind/Shutter to a frost alarm. The Blind/Shutter is moved to the defined position and blocked.

A frost alarm does not inevitably lead to movement of the Blind/Shutter.

i Note

Whether a movement takes place is dependent on the following factors:

- Parameterization of the output → [Function diagram Shutter Actuator, Page 86](#)
- Priorities → [Priorities, Page 281](#)

More information: → [Frost alarm, Page 89](#).

i Note

If a weather alarm is active, Blind/Shutter control via other Group Objects, manual operation or i-bus® Tool is blocked. Travel range limits are ignored.

Higher-priority safety functions continue to run → [Function diagram Shutter Actuator, Page 86](#).

Option	
<i>No reaction/deactivated</i>	The Shutter Actuator output pair does not react to the alarm.
<i>Up</i>	Acts like an Up telegram on the Group Object Move Blind/Shutter Up/Down .
<i>Down</i>	Acts like a Down telegram on the Group Object Move Blind/Shutter Up/Down .
<i>Stop</i>	Acts like a Stop telegram on one of the following Group Objects: <ul style="list-style-type: none"> • Stop Up/Down • Slat adjustment / Stop Up/Down
<i>Complete movement</i>	If the Blind/Shutter is moving, it will continue until reaching the target position. If the Blind/Shutter is at rest, its position will remain unchanged.
<i>Scene assignment</i>	The reaction specified in Scene assignment x is performed. The following dependent parameters are shown: <ul style="list-style-type: none"> • Scene assignment
<i>Individual position</i>	The required positions of the Blind/Shutter and slats (depending on operating mode) can be defined in separate parameters. The following dependent parameters are shown: <ul style="list-style-type: none"> • Position height (0 % = top; 100 % = bottom) • Position slat (0 % = open; 100 % = closed)

Prerequisites for visibility

- Parameter window [Configuration](#)
 - Parameter [Enable output X + Y](#) \ Option *Yes*
 - Parameter [Application](#) \ Option *Shutter Actuator*
- Parameter window [Safety/Weather alarms](#) \ Parameter [Enable Group Object "Frost alarm"](#) \ Option *Yes*
- Parameter window [Shutter Actuator X+Y](#) \ Parameter window [Shutter Actuator functions](#) \ Parameter [Enable function Safety/Weather alarms](#) \ Option *Yes*
- Parameter window [Shutter Actuator X+Y](#) \ Parameter window [Safety/Weather alarms](#) \ Parameter [Parameter setting](#) \ Option *Individual*
- The parameter is in the parameter window [Shutter Actuator X+Y](#) \ parameter window [Safety/Weather alarms](#).

7.4.19 Blind/Shutter reaction on rain alarm

This parameter is used to define the reaction of the Blind/Shutter to a rain alarm. The Blind/Shutter is moved to the defined position and blocked.

A rain alarm does not inevitably lead to movement of the Blind/Shutter.

i Note

Whether a movement takes place is dependent on the following factors:

- Parameterization of the output → [Function diagram Shutter Actuator, Page 86](#)
- Priorities → [Priorities, Page 281](#)

More information: → [Rain alarm, Page 89](#).

i Note

If a weather alarm is active, Blind/Shutter control via other Group Objects, manual operation or i-bus® Tool is blocked. Travel range limits are ignored.

Higher-priority safety functions continue to run → [Function diagram Shutter Actuator, Page 86](#).

Option	
<i>No reaction/deactivated</i>	The Shutter Actuator output pair does not react to the alarm.
<i>Up</i>	Acts like an Up telegram on the Group Object Move Blind/Shutter Up/Down .
<i>Down</i>	Acts like a Down telegram on the Group Object Move Blind/Shutter Up/Down .
<i>Stop</i>	Acts like a Stop telegram on one of the following Group Objects: <ul style="list-style-type: none"> • Stop Up/Down • Slat adjustment / Stop Up/Down
<i>Complete movement</i>	If the Blind/Shutter is moving, it will continue until reaching the target position. If the Blind/Shutter is at rest, its position will remain unchanged.
<i>Scene assignment</i>	The reaction specified in Scene assignment x is performed. The following dependent parameters are shown: <ul style="list-style-type: none"> • Scene assignment
<i>Individual position</i>	The required positions of the Blind/Shutter and slats (depending on operating mode) can be defined in separate parameters. The following dependent parameters are shown: <ul style="list-style-type: none"> • Position height (0 % = top; 100 % = bottom) • Position slat (0 % = open; 100 % = closed)

Prerequisites for visibility

- Parameter window [Configuration](#)
 - Parameter [Enable output X + Y](#) \ Option *Yes*
 - Parameter [Application](#) \ Option *Shutter Actuator*
- Parameter window [Safety/Weather alarms](#) \ Parameter [Enable Group Object "Rain alarm"](#) \ Option *Yes*
- Parameter window [Shutter Actuator X+Y](#) \ Parameter window [Shutter Actuator functions](#) \ Parameter [Enable function Safety/Weather alarms](#) \ Option *Yes*
- Parameter window [Shutter Actuator X+Y](#) \ Parameter window [Safety/Weather alarms](#) \ Parameter [Parameter setting](#) \ Option *Individual*
- The parameter is in the parameter window [Shutter Actuator X+Y](#) \ parameter window [Safety/Weather alarms](#).

7.4.20

Blind/Shutter reaction on cancellation of weather alarm, block and forced operation

This parameter is used to define the reaction of the Blind/Shutter after cancellation of safety functions (weather alarms, block or forced operation).

The cancellation of safety functions does not inevitably lead to movement of the Blind/Shutter.

Note

Whether a movement takes place is dependent on the following factors:

- Parameterization of the output → [Function diagram Shutter Actuator, Page 86](#)
- Priorities → [Priorities, Page 281](#)

More information: → [Safety functions of Shutter Actuator, Page 88](#).

Option	
<i>No reaction</i>	If the Blind/Shutter is moving, it will continue until reaching the target position. If the Blind/Shutter is at rest, its position will remain unchanged.
<i>Up</i>	Acts like an Up telegram on the Group Object Move Blind/Shutter Up/Down .
<i>Down</i>	Acts like a Down telegram on the Group Object Move Blind/Shutter Up/Down .
<i>Stop</i>	Acts like a Stop telegram on one of the following Group Objects: <ul style="list-style-type: none"> • Stop Up/Down • Slat adjustment / Stop Up/Down
<i>Scene assignment</i>	The reaction specified in Scene assignment x is performed. The following dependent parameters are shown: <ul style="list-style-type: none"> • Scene assignment
<i>Individual position</i>	The required positions of the Blind/Shutter and slats (depending on operating mode) can be defined in separate parameters. The following dependent parameters are shown: <ul style="list-style-type: none"> • Position height (0 % = top; 100 % = bottom) • Position slat (0 % = open; 100 % = closed)
<i>Refreshed KNX state</i>	The Blind/Shutter is moved to the position defined by the refreshed KNX state. → Refreshed KNX state, Page 291 Telegrams received on the Group Objects Move Blind/Shutter Up/Down and Slat adjustment / Stop Up/Down during an active safety function are not taken into consideration.

Prerequisites for visibility

- Parameter window [Configuration](#)
 - Parameter [Enable output X + Y](#) \ Option *Yes*
 - Parameter [Application](#) \ Option *Shutter Actuator*
- Parameter window [Shutter Actuator X+Y](#) \ Parameter window [Shutter Actuator functions](#) \ Parameter [Enable function Safety/Weather alarms](#) \ Option *Yes*
- Parameter window [Shutter Actuator X+Y](#) \ Parameter window [Safety/Weather alarms](#) \ Parameter [Parameter setting](#) \ Option *Individual*
- The parameter is in the parameter window [Shutter Actuator X+Y](#) \ parameter window [Safety/Weather alarms](#).

7.4.21 Blind/Shutter reaction on block

This parameter is used to define the reaction of the Blind/Shutter if blocked. The Blind/Shutter is moved to the defined position and blocked.

The blocking of the output does not inevitably lead to movement of the Blind/Shutter.

i Note

Whether a movement takes place is dependent on the following factors:

- Parameterization of the output → [Function diagram Shutter Actuator, Page 86](#)
- Priorities → [Priorities, Page 281](#)

More information: → [Block, Page 90](#).

i Note

If the safety function is active, the operation of the output via Group Objects, manual operation and i-bus® Tool is blocked.

Higher-priority safety functions continue to run.

→ [Function diagram Shutter Actuator, Page 86](#)

→ [Function diagram Switch Actuator, Page 87](#)

Option	
<i>No reaction/deactivated</i>	The function <i>Block</i> is deactivated.
<i>Up</i>	Acts like an Up telegram on the Group Object <i>Move Blind/Shutter Up/Down</i> . The following dependent Group Objects are displayed: <ul style="list-style-type: none"> • <i>Block</i>
<i>Down</i>	Acts like a Down telegram on the Group Object <i>Move Blind/Shutter Up/Down</i> . The following dependent Group Objects are displayed: <ul style="list-style-type: none"> • <i>Block</i>
<i>Stop</i>	Acts like a Stop telegram on one of the following Group Objects: <ul style="list-style-type: none"> • <i>Stop Up/Down</i> • <i>Slat adjustment / Stop Up/Down</i> The following dependent Group Objects are displayed: <ul style="list-style-type: none"> • <i>Block</i>
<i>Complete movement</i>	If the Blind/Shutter is moving, it will continue until reaching the target position. If the Blind/Shutter is at rest, its position will remain unchanged. The following dependent Group Objects are displayed: <ul style="list-style-type: none"> • <i>Block</i>
<i>Scene assignment</i>	The reaction specified in Scene assignment x is performed. The following dependent parameters are shown: <ul style="list-style-type: none"> • <i>Scene assignment</i> The following dependent Group Objects are displayed: <ul style="list-style-type: none"> • <i>Block</i>
<i>Individual position</i>	The required positions of the Blind/Shutter and slats (depending on operating mode) can be defined in separate parameters. The following dependent parameters are shown: <ul style="list-style-type: none"> • <i>Position height (0 % = top; 100 % = bottom)</i> • <i>Position slat (0 % = open; 100 % = closed)</i> The following dependent Group Objects are displayed: <ul style="list-style-type: none"> • <i>Block</i>

Prerequisites for visibility

- Parameter window *Configuration*
 - Parameter *Enable output X + Y* \ Option *Yes*
 - Parameter *Application* \ Option *Shutter Actuator*
- Parameter window *Shutter Actuator X+Y* \ Parameter window *Shutter Actuator functions* \ Parameter *Enable function Safety/Weather alarms* \ Option *Yes*
- Parameter window *Shutter Actuator X+Y* \ Parameter window *Safety/Weather alarms* \ Parameter *Parameter setting* \ Option *Individual*
- The parameter is in the parameter window *Shutter Actuator X+Y* \ parameter window *Safety/Weather alarms*.

7.4.22 Blind/Shutter reaction on wind alarm

This parameter is used to define the reaction of the Blind/Shutter to a wind alarm. The Blind/Shutter is moved to the defined position and blocked.

A wind alarm does not inevitably lead to movement of the Blind/Shutter.

Note

Whether a movement takes place is dependent on the following factors:

- Parameterization of the output → [Function diagram Shutter Actuator, Page 86](#)
- Priorities → [Priorities, Page 281](#)

More information: → [Wind alarm, Page 88](#).

Note

If a weather alarm is active, Blind/Shutter control via other Group Objects, manual operation or i-bus® Tool is blocked. Travel range limits are ignored.

Higher-priority safety functions continue to run → [Function diagram Shutter Actuator, Page 86](#).

Option	
<i>No reaction/deactivated</i>	The Shutter Actuator output pair does not react to the alarm.
<i>Up</i>	Acts like an Up telegram on the Group Object <i>Move Blind/Shutter Up/Down</i> .
<i>Down</i>	Acts like a Down telegram on the Group Object <i>Move Blind/Shutter Up/Down</i> .
<i>Stop</i>	Acts like a Stop telegram on one of the following Group Objects: <ul style="list-style-type: none"> • <i>Stop Up/Down</i> • <i>Slat adjustment / Stop Up/Down</i>
<i>Complete movement</i>	If the Blind/Shutter is moving, it will continue until reaching the target position. If the Blind/Shutter is at rest, its position will remain unchanged.
<i>Scene assignment</i>	The reaction specified in Scene assignment x is performed. The following dependent parameters are shown: <ul style="list-style-type: none"> • <i>Scene assignment</i>
<i>Individual position</i>	The required positions of the Blind/Shutter and slats (depending on operating mode) can be defined in separate parameters. The following dependent parameters are shown: <ul style="list-style-type: none"> • <i>Position height (0 % = top; 100 % = bottom)</i> • <i>Position slat (0 % = open; 100 % = closed)</i>

Prerequisites for visibility

- Parameter window *Configuration*
 - Parameter *Enable output X + Y* \ Option *Yes*
 - Parameter *Application* \ Option *Shutter Actuator*
- Parameter window *Safety/Weather alarms* \ Parameter *Enable Group Object "Wind alarm x"* \ Option *Yes*
- Parameter window *Shutter Actuator X+Y* \ Parameter window *Shutter Actuator functions* \ Parameter *Enable function Safety/Weather alarms* \ Option *Yes*
- Parameter window *Shutter Actuator X+Y* \ Parameter window *Safety/Weather alarms*
 - Parameter *Parameter setting* \ Option *Individual*
 - Parameter *Output reacts to wind alarm x* \ Option *Yes*
- The parameter is in the parameter window *Shutter Actuator X+Y* \ parameter window *Safety/Weather alarms*.

7.4.23

Monitor range between thresholds

This parameter is used to define whether the range between the thresholds is monitored and evaluated via the Group Object *Status Input value between thresholds*.

Option	
<i>No</i>	The range between the thresholds is not monitored and evaluated.
<i>Yes</i>	The following dependent parameters are shown: <ul style="list-style-type: none"> • <i>Minimum dwell time between the thresholds</i>

Prerequisites for visibility

- Parameter window *Configuration* \ Parameter *Enable Logic/Threshold x-y* \ Option *Yes*
- Parameter window *Logic/Threshold* \ Parameter window *Logic/Threshold x* \ Parameter *Function of the logic gate* \ Option *Threshold*
- The parameter is in the parameter window *Logic/Threshold* \ parameter window *Logic/Threshold x*.

7.4.24 Description

This parameter is used to define a description of an output, a channel or a group. The description is displayed at the following points:

- In i-bus® Tool
- In the name of the corresponding parameter window
- In the name of the corresponding Group Objects

i Note

The interface to i-bus® Tool is available from the following software versions:

- Application from V1.2
- Firmware from V0.2.0

Option

<i>Free text entry</i>	Maximum 24 ASCII characters; the maximum number of characters may vary for other character formats.
------------------------	---

Prerequisites for visibility

- The parameter appears at various points in the application. The visibility is dependent on the application and the higher-level parameter.

7.4.25 Operating mode

This parameter can be used to set the operating mode of the Shutter Actuator output pair. The parameter window *Blind/Shutter* differs according to the operating mode.

Option

<i>Blind/Shutter control with slat adjustment</i>	To control shutters, vertical blinds and other shading systems with slats, etc. The following dependent Group Objects are displayed: <ul style="list-style-type: none"> • <i>Move Blind/Shutter Up/Down</i> • <i>Slat adjustment / Stop Up/Down</i>
<i>Blind/Shutter control without slat adjustment</i>	To control blinds, awnings and other products without slats, as well as window and door drives, etc. The following dependent Group Objects are displayed: <ul style="list-style-type: none"> • <i>Move Blind/Shutter Up/Down</i> • <i>Stop Up/Down</i>

Prerequisites for visibility

- Parameter window *Configuration*
 - Parameter *Enable output X + Y* \ Option *Yes*
 - Parameter *Application* \ Option *Shutter Actuator*
- The parameter is in the parameter window *Shutter Actuator X+Y* \ parameter window *Shutter Actuator functions*.

7.4.26 Flashing if Group Object "Flashing" is

This parameter is used to set the telegram value with which flashing is started and prematurely ended.

Option	
<i>On (1) or off (0)</i>	A telegram with the value 1 or 0 starts the flashing. Flashing cannot be ended prematurely.
<i>On (1)</i>	A telegram with the value 1 starts the flashing. A telegram with the value 0 ends flashing.
<i>Off (0)</i>	A telegram with the value 0 starts the flashing. A telegram with the value 1 ends flashing.

Prerequisites for visibility

- Parameter window [Configuration](#)
 - Parameter [Enable output X + Y](#) \ Option *Yes*
 - Parameter [Application](#) \ Option *Switch Actuator*
- Parameter window [Switch Actuator X](#) \ Parameter window [Functions Switch Actuator](#) \ Parameter [Enable function Time](#) \ Option *Flashing*
- Parameter window [Switch Actuator X](#) \ Parameter window [Flashing](#) \ Parameter [Parameter setting](#) \ Option *Individual*
- The parameter is in the parameter window [Switch Actuator X](#) \ parameter window [Flashing](#).

7.4.27 Data point type of Group Object "Threshold input"

This parameter is used to define the data point type that is received via the Group Object "Threshold input" and evaluated.

Option	
<i>Percent (DPT 5.001)</i>	The following dependent Group Objects are displayed: <ul style="list-style-type: none"> • Threshold input (DPT 5.001)
<i>Meter pulses (DPT 5.010)</i>	The following dependent Group Objects are displayed: <ul style="list-style-type: none"> • Threshold input (DPT 5.010)
<i>Meter pulses (DPT 7.001)</i>	The following dependent Group Objects are displayed: <ul style="list-style-type: none"> • Threshold input (DPT 7.001)
<i>Temperature (DPT 9.001)</i>	The following dependent Group Objects are displayed: <ul style="list-style-type: none"> • Threshold input (DPT 9.001)
<i>Lux (DPT 9.004)</i>	The following dependent Group Objects are displayed: <ul style="list-style-type: none"> • Threshold input (DPT 9.004)
<i>mA (DPT 9.021)</i>	The following dependent Group Objects are displayed: <ul style="list-style-type: none"> • Threshold input (DPT 9.021)
<i>A (DPT 14.019)</i>	The following dependent Group Objects are displayed: <ul style="list-style-type: none"> • Threshold input (DPT 14.019)
<i>W (DPT 14.056)</i>	The following dependent Group Objects are displayed: <ul style="list-style-type: none"> • Threshold input (DPT 14.056)
<i>kW (DPT 9.024)</i>	The following dependent Group Objects are displayed: <ul style="list-style-type: none"> • Threshold input (DPT 9.024)
<i>Wh (DPT 13.010)</i>	The following dependent Group Objects are displayed: <ul style="list-style-type: none"> • Threshold input (DPT 13.010)
<i>kWh (DPT 13.013)</i>	The following dependent Group Objects are displayed: <ul style="list-style-type: none"> • Threshold input (DPT 13.013)

Prerequisites for visibility

- Parameter window [Configuration](#) \ Parameter [Enable Logic/Threshold x-y](#) \ Option *Yes*
- Parameter window [Logic/Threshold](#) \ Parameter window [Logic/Threshold x](#) \ Parameter [Function of the logic gate](#) \ Option *Threshold*
- The parameter is in the parameter window [Logic/Threshold](#) \ parameter window [Logic/Threshold x](#).

7.4.28 Request Date/Time via Group Object

This parameter is used to define whether a date and time request is sent via the Group Object [Request Date/Time](#).

Option	
No	The request is not sent.
Yes	The request is sent 30 seconds after switching on the device. An active send and switching delay is not taken into account.

Prerequisites for visibility

- Parameter window [Device settings](#) \ Parameter [Enable Time Group Objects for setting of device time](#) \ all options except *No*
- The parameter is in the parameter window [Device settings](#).

7.4.29 Duration for tensioning

This parameter is used to define the duration for which the Blind/Shutter is to move in the opposite direction after a down movement.

Option	
<i>0... 5,000 ms</i>	

Prerequisites for visibility

- Parameter window [Configuration](#)
 - Parameter [Enable output X + Y](#) \ Option *Yes*
 - Parameter [Application](#) \ Option *Shutter Actuator*
- Parameter window [Shutter Actuator X+Y](#) \ Parameter window [Shutter Actuator functions](#) \ Parameter [Operating mode](#) \ Option *Blind/Shutter control without slat adjustment*
- Parameter window [Shutter Actuator X+Y](#) \ Parameter window [Blind/Shutter](#)
 - Parameter [Parameter setting](#) \ Option *Individual*
 - Parameter [Tensioning/Slot positioning](#) \ Options *After each down movement / After reaching lower end position*
- The parameter is in the parameter window [Shutter Actuator X+Y](#) \ parameter window [Blind/Shutter](#).

7.4.30 Deactivation of Automatic sun protection

This parameter is used to define how the function *Automatic sun protection* can be deactivated.

More information: → [Activation/deactivation of Automatic sun protection, Page 101](#).

Option	
<u>Via Group Object</u>	Automatic sun protection is activated (1) or deactivated (0) exclusively by a telegram on the Group Object Activate/Deactivate Automatic sun protection .
<u>Via Group Object or direct command</u>	Automatic sun protection is activated (1) or deactivated (0) by a telegram on the Group Object Activate/Deactivate Automatic sun protection . In addition, incoming telegrams on the direct Group Objects result in the deactivation of the Automatic sun protection → Direct operation, Page 102
The following dependent parameters are shown:	
<ul style="list-style-type: none"> • Automatic reactivation of Automatic sun protection 	

Prerequisites for visibility

- Parameter window [Configuration](#)
 - Parameter [Enable output X + Y](#) \ Option *Yes*
 - Parameter [Application](#) \ Option *Shutter Actuator*
- Parameter window [Shutter Actuator X+Y](#) \ Parameter window [Shutter Actuator functions](#) \ Parameter [Enable function Automatic sun protection](#) \ Option *Yes*
- Parameter window [Shutter Actuator X+Y](#) \ Parameter window [Automatic sun protection](#) \ Parameter [Parameter setting](#) \ Option *Individual*
- The parameter is in the parameter window [Shutter Actuator X+Y](#) \ parameter window [Automatic sun protection](#).

7.4.31 Block delay for switching on and off after bus voltage recovery

This parameter is used to define whether the function *Delay for switching on and off* is blocked after bus voltage recovery.

Option	
<u>No</u>	
<u>Yes</u>	

Prerequisites for visibility

- Parameter window [Configuration](#)
 - Parameter [Enable output X + Y](#) \ Option *Yes*
 - Parameter [Application](#) \ Option *Switch Actuator*
- Parameter window [Switch Actuator X](#) \ Parameter window [Functions Switch Actuator](#) \ Parameter [Enable function Time](#) \ Option *Delay for switching on and off*
- Parameter window [Switch Actuator X](#) \ Parameter window [Delay for switching on and off](#)
 - Parameter [Parameter setting](#) \ Option *Individual*
 - Parameter [Block delay for switching on and off via Group Object](#) \ Option *Yes*
- The parameter is in the parameter window [Switch Actuator X](#) \ parameter window [Delay for switching on and off](#).

7.4.32 Block delay for switching on and off via Group Object

This parameter is used to define whether the function *Delay for switching on and off* can be blocked via a Group Object.

If the function *Delay for switching on and off* is blocked, the switch-on command is forwarded without time function in the function chain. The output reacts according to its parameterization. After a download, the function *Delay for switching on and off* remains blocked.

Option	
<i>No</i>	The delay for switching on and off cannot be blocked via a Group Object.
<i>Yes</i>	The following dependent parameters are shown: <ul style="list-style-type: none"> • Block delay for switching on and off after bus voltage recovery The following dependent Group Objects are displayed: <ul style="list-style-type: none"> • Block delay for switching on and off

Prerequisites for visibility

- Parameter window [Configuration](#)
 - Parameter [Enable output X + Y](#) \ Option *Yes*
 - Parameter [Application](#) \ Option *Switch Actuator*
- Parameter window [Switch Actuator X](#) \ Parameter window [Functions Switch Actuator](#) \ Parameter [Enable function Time](#) \ Option *Delay for switching on and off*
- Parameter window [Switch Actuator X](#) \ Parameter window [Delay for switching on and off](#) \ Parameter [Parameter setting](#) \ Option *Individual*
- The parameter is in the parameter window [Switch Actuator X](#) \ parameter window [Delay for switching on and off](#).

7.4.33 Read input Group Objects after bus voltage recovery and download

This parameter is used to define whether the following input Group Objects are read after bus voltage recovery or download:

- [Connection A](#)
- [Connection B](#)
- [Threshold input](#) (DPT 5.001)
- [Threshold input](#) (DPT 5.010)
- [Threshold input](#) (DPT 7.001)
- [Threshold input](#) (DPT 9.001)
- [Threshold input](#) (DPT 9.004)

Note

To update the Group Objects after bus voltage recovery and download, the read flags must be set for the corresponding Group Objects of the sending device.

Option	
<i>No</i>	The input Group Objects are not read. The results of the functions <i>Logic</i> and <i>Threshold</i> are recalculated only if a new value is received on one of the input Group Objects.
<i>Yes</i>	The input Group Objects are read. The results of the functions <i>Logic</i> and <i>Threshold</i> are recalculated.

Prerequisites for visibility

- Parameter window [Configuration](#) \ Parameter [Enable Logic/Threshold x-y](#) \ Option *Yes*
- Parameter window [Logic/Threshold](#) \ Parameter window [Logic/Threshold x](#) \ Parameter [Function of the logic gate](#) \ all options except *None*
- The parameter is in the parameter window [Logic/Threshold](#) \ parameter window [Logic/Threshold x](#).

7.4.34 Duration of slat adjustment/step

This parameter is used to set the duration of a single slat adjustment (step).

i Note

Refer to the motor's data sheet for the duration of a single slat adjustment.

i Note

The device cannot process times shorter than 50 ms.

Option

50 ... 200 ... 1000 ms

Prerequisites for visibility

- Parameter window [Configuration](#)
 - Parameter [Enable output X + Y](#) \ Option *Yes*
 - Parameter [Application](#) \ Option *Shutter Actuator*
- Parameter window [Shutter Actuator X+Y](#) \ Parameter window [Shutter Actuator functions](#) \ Parameter [Operating mode](#) \ Option *Blind/Shutter control with slat adjustment*
- Parameter window [Shutter Actuator X+Y](#) \ Parameter window [Blind/Shutter](#)
 - Parameter [Parameter setting](#) \ Option *Individual*
 - Parameter [Determine slat adjustment time](#) \ Option *Via duration of slat adjustment*
- The parameter is in the parameter window [Shutter Actuator X+Y](#) \ parameter window [Blind/Shutter](#).

7.4.35 Delay for switching on

This parameter is used to define the switch-on delay for the output after an On telegram is received.

More information: → [Function Delay for switching on and off, Page 106](#).

Option

00:00:00 ... 18:12:15 hh:mm:ss

Prerequisites for visibility

- Parameter window [Configuration](#)
 - Parameter [Enable output X + Y](#) \ Option *Yes*
 - Parameter [Application](#) \ Option *Switch Actuator*
- Parameter window [Switch Actuator X](#) \ Parameter window [Functions Switch Actuator](#) \ Parameter [Enable function Time](#) \ Option *Delay for switching on and off*
- Parameter window [Switch Actuator X](#) \ Parameter window [Delay for switching on and off](#) \ Parameter [Parameter setting](#) \ Option *Individual*
- The parameter is in the parameter window [Switch Actuator X](#) \ parameter window [Delay for switching on and off](#).

7.4.36 Invert result

This parameter is used to define whether the result of the function *Logic* is output inverted.

Option	
<i>No</i>	
<i>Yes</i>	

Prerequisites for visibility

- Parameter window [Configuration](#) \ Parameter [Enable Logic/Threshold x-y](#) \ Option *Yes*
- Parameter window [Logic/Threshold](#) \ Parameter window [Logic/Threshold x](#) \ Parameter [Function of the logic gate](#) \ Options *AND / OR / Exclusive OR / GATE*
- The parameter is in the parameter window [Logic/Threshold](#) \ parameter window [Logic/Threshold x](#).

7.4.37 Result if upper threshold is exceeded

This parameter is used to define the result of the function *Threshold* when the value received at the threshold input exceeds the upper threshold.

The result can be linked with any output within the device or output on the Group Object [Status Result \[Threshold\]](#).

Option	
<i>Unchanged</i>	The result of the function <i>Threshold</i> remains unchanged.
<i>1</i>	The result of the function <i>Threshold</i> is 1.
<i>0</i>	The result of the function <i>Threshold</i> is 0.

Prerequisites for visibility

- Parameter window [Configuration](#) \ Parameter [Enable Logic/Threshold x-y](#) \ Option *Yes*
- Parameter window [Logic/Threshold](#) \ Parameter window [Logic/Threshold x](#) \ Parameter [Function of the logic gate](#) \ Option *Threshold*
- The parameter is in the parameter window [Logic/Threshold](#) \ parameter window [Logic/Threshold x](#).

7.4.38 Result if lower threshold is dropped below

This parameter is used to define the result of the function *Threshold* when the value received at the threshold input falls below the lower threshold.

The result can be linked with any output within the device or output on the Group Object [Status Result \[Threshold\]](#).

Option	
<i>Unchanged</i>	The result of the function <i>Threshold</i> remains unchanged.
<i>1</i>	The result of the function <i>Threshold</i> is 1.
<i>0</i>	The result of the function <i>Threshold</i> is 0.

Prerequisites for visibility

- Parameter window [Configuration](#) \ Parameter [Enable Logic/Threshold x-y](#) \ Option *Yes*
- Parameter window [Logic/Threshold](#) \ Parameter window [Logic/Threshold x](#) \ Parameter [Function of the logic gate](#) \ Option *Threshold*
- The parameter is in the parameter window [Logic/Threshold](#) \ parameter window [Logic/Threshold x](#).

7.4.39 Limit travel range via Group Object

This parameter is used to limit the travel range of the Blind/Shutter, e.g. to prevent the Blind/Shutter from moving all the way down when a terrace door is open.

More information: → [Travel range limit, Page 288](#).

Option	
<i>No</i>	The travel range is not limited.
<i>Move Blind/Shutter Up/Down limited</i>	<p>The limitation of the travel range is active if movement commands are received on the following Group Objects:</p> <ul style="list-style-type: none"> • Group Object <i>Move Blind/Shutter Up/Down limited</i> • Group Object <i>Scene 1 ... 64</i> <p>The limit does not apply to:</p> <ul style="list-style-type: none"> • Group Object <i>Move Blind/Shutter Up/Down</i> • Group Object <i>Move to position height</i> • → Central Group Objects, Page 292 • → Special operating states, Page 108 • → Safety functions of Shutter Actuator, Page 88 • → Manual operation, Page 277 • → Function Automatic sun protection, Page 100 • Settings in the parameter <i>Move to position</i> • → Travel time determination, Page 284 • → reference movement, Page 286 <p>The following dependent parameters are shown:</p> <ul style="list-style-type: none"> • <i>Upper limit (0 % = top; 100 % = bottom)</i> • <i>Lower limit (0 % = top; 100 % = bottom)</i> <p>The following dependent Group Objects are displayed:</p> <ul style="list-style-type: none"> • <i>Move Blind/Shutter Up/Down limited</i>
<i>Activate limitation</i>	<p>The limitation of the travel range can be activated/deactivated via the Group Object <i>Activate/Deactivate limitation</i>.</p> <p>The limit does not apply to:</p> <ul style="list-style-type: none"> • → Special operating states, Page 108 • → Safety functions of Shutter Actuator, Page 88 • → Manual operation, Page 277 • Settings in the parameter <i>Move to position</i> • → Travel time determination, Page 284 • → reference movement, Page 286 <p>The following dependent parameters are shown:</p> <ul style="list-style-type: none"> • <i>Upper limit (0 % = top; 100 % = bottom)</i> • <i>Lower limit (0 % = top; 100 % = bottom)</i> • <i>Upper limit valid for Automatic sun protection commands</i> • <i>Upper limit valid for direct commands</i> • <i>Lower limit valid for Automatic sun protection commands</i> • <i>Lower limit valid for direct commands</i> <p>The following dependent Group Objects are displayed:</p> <ul style="list-style-type: none"> • <i>Activate/Deactivate limitation</i>

Prerequisites for visibility

- Parameter window *Configuration*
 - Parameter *Enable output X + Y* \ Option *Yes*
 - Parameter *Application* \ Option *Shutter Actuator*
- Parameter window *Shutter Actuator X+Y* \ Parameter window *Blind/Shutter* \ Parameter *Parameter setting* \ Option *Individual*
- The parameter is in the parameter window *Shutter Actuator X+Y* \ parameter window *Blind/Shutter*.

7.4.40 Travel time down

This parameter is used to define how long the Blind/Shutter takes to move from the upper to the lower end positions. The travel time must first be measured manually.

i Note

Physical and weather-related circumstances (frost, UV radiation, long-term use or use of heavy Blind/Shutter types) mean that differing total travel times may result for a complete movement from the lower end position to the upper end position (Up) and from the upper end position to the lower end position (Down). The total travel times can be set separately to permit exact positioning of the Blind/Shutter.

Option

00:01:00... 00:10:00 hh:mm:ss

Prerequisites for visibility

- Parameter window [Configuration](#)
 - Parameter [Enable output X + Y](#) \ Option *Yes*
 - Parameter [Application](#) \ Option *Shutter Actuator*
- Parameter window [Shutter Actuator X+Y](#) \ Parameter window [Drive](#) \ Parameter [Parameter setting](#) \ Option *Individual*
- The parameter is in the parameter window [Shutter Actuator X+Y](#) \ parameter window [Drive](#).

7.4.41 Travel time up

This parameter is used to define how long the Blind/Shutter takes to move from the lower to the upper end positions. The travel time must first be measured manually.

i Note

Physical and weather-related circumstances (frost, UV radiation, long-term use or use of heavy Blind/Shutter types) mean that differing total travel times may result for a complete movement from the lower end position to the upper end position (Up) and from the upper end position to the lower end position (Down). The total travel times can be set separately to permit exact positioning of the Blind/Shutter.

Option

00:01:00... 00:10:00 hh:mm:ss

Prerequisites for visibility

- Parameter window [Configuration](#)
 - Parameter [Enable output X + Y](#) \ Option *Yes*
 - Parameter [Application](#) \ Option *Shutter Actuator*
- Parameter window [Shutter Actuator X+Y](#) \ Parameter window [Drive](#) \ Parameter [Parameter setting](#) \ Option *Individual*
- The parameter is in the parameter window [Shutter Actuator X+Y](#) \ parameter window [Drive](#).

7.4.42 Function of the logic gate

This parameter is used to define whether one of the logic functions or the threshold function is used.

Option	
<i>None</i>	The logic gate is not used.
AND	<p>The logic function <i>AND</i> is used. If the value 1 is present on all inputs, the result = 1.</p> <p>The following dependent parameters are shown:</p> <ul style="list-style-type: none"> • Value of Group Object "Connection A" after bus voltage recovery • Value of Group Object "Connection B" after bus voltage recovery • Read input Group Objects after bus voltage recovery and download • Invert result • Enable Group Object "Status Result" <p>The following dependent Group Objects are displayed:</p> <ul style="list-style-type: none"> • Connection A • Connection B
OR	<p>The logic function <i>OR</i> is used. If the value 1 is present on at least one input, the result = 1.</p> <p>The following dependent parameters are shown:</p> <ul style="list-style-type: none"> • Value of Group Object "Connection A" after bus voltage recovery • Value of Group Object "Connection B" after bus voltage recovery • Read input Group Objects after bus voltage recovery and download • Invert result • Enable Group Object "Status Result" <p>The following dependent Group Objects are displayed:</p> <ul style="list-style-type: none"> • Connection A • Connection B
<i>Exclusive OR</i>	<p>The logic function <i>exclusive OR</i> is used. If the value 1 is present on at least one input, the result = 1. If the same value is present on all inputs, the result = 0.</p> <p>The following dependent parameters are shown:</p> <ul style="list-style-type: none"> • Value of Group Object "Connection A" after bus voltage recovery • Value of Group Object "Connection B" after bus voltage recovery • Read input Group Objects after bus voltage recovery and download • Invert result • Enable Group Object "Status Result" <p>The following dependent Group Objects are displayed:</p> <ul style="list-style-type: none"> • Connection A • Connection B
GATE	<p>The logic function <i>GATE</i> is used. If the GATE is open (Connection A), the most recent value sent to the input (Connection B) remains as the result. If the GATE is blocked (Connection A), the value that the result had before the block is retained. After enabling, the result corresponds to the value of the input (Connection B).</p> <p>The following dependent parameters are shown:</p> <ul style="list-style-type: none"> • GATE blocks if Group Object "Connection A" equals • Value of Group Object "Connection A" after bus voltage recovery • Value of Group Object "Connection B" after bus voltage recovery • Read input Group Objects after bus voltage recovery and download • Invert result • Enable Group Object "Status Result" <p>The following dependent Group Objects are displayed:</p> <ul style="list-style-type: none"> • Connection A • Connection B
<i>Threshold</i>	<p>The function <i>Threshold</i> is used. More information: → Function Threshold, Page 94.</p> <p>The following dependent parameters are shown:</p> <ul style="list-style-type: none"> • Data point type of Group Object "Threshold input" • Upper threshold • Lower threshold • Change thresholds via Group Objects • Change thresholds via i-bus® Tool • Result if upper threshold is exceeded • Min. duration of the overshoot • Monitor range between thresholds • Result if lower threshold is dropped below • Min. duration of the undershoot • Read input Group Objects after bus voltage recovery and download • Enable Group Objects "Status Result" and "Status Input value between thresholds"
<i>1 bit Inverter</i>	<p>The logic function <i>1 bit Inverter</i> is used. If the value 1 is present at the input, the result = 0. If the value 0 is present at the input, the result = 1.</p> <p>The following dependent parameters are shown:</p> <ul style="list-style-type: none"> • Value of Group Object "Connection A" after bus voltage recovery • Read input Group Objects after bus voltage recovery and download • Enable Group Object "Status Result" <p>The following dependent Group Objects are displayed:</p> <ul style="list-style-type: none"> • Connection A

Prerequisites for visibility

- Parameter window [Configuration](#) \ Parameter [Enable Logic/Threshold x-y](#) \ Option *Yes*
- The parameter is in the parameter window [Logic/Threshold x](#).

7.4.43 Enable function Load shedding

This parameter enables the function *Load shedding* and the related parameter window [Load shedding](#) is displayed.

Option	
<i>No</i>	The function is not enabled.
<i>Yes</i>	The following dependent parameter windows are shown: <ul style="list-style-type: none"> • Load shedding

Prerequisites for visibility

- Parameter window [Configuration](#)
 - Parameter [Enable output X + Y](#) \ Option *Yes*
 - Parameter [Application](#) \ Option *Switch Actuator*
- The parameter is in the parameter window [Switch Actuator X](#) \ parameter window [Functions Switch Actuator](#).

7.4.44 Enable function Safety

This parameter enables the function *Safety* and the related parameter window [Safety](#) is displayed.

Option	
<i>No</i>	The function is not enabled.
<i>Yes</i>	The following dependent parameter windows are shown: <ul style="list-style-type: none"> • Safety

Prerequisites for visibility

- Parameter window [Configuration](#)
 - Parameter [Enable output X + Y](#) \ Option *Yes*
 - Parameter [Application](#) \ Option *Switch Actuator*
- The parameter is in the parameter window [Switch Actuator X](#) \ parameter window [Functions Switch Actuator](#).

7.4.45 Enable function Safety/Weather alarms

This parameter enables the functions *Safety* and *Weather alarms* and the related parameter window [Safety/Weather alarms](#) is displayed.

Option	
<i>No</i>	The function is not enabled.
<i>Yes</i>	The following dependent parameter windows are shown: <ul style="list-style-type: none"> • Safety/Weather alarms

Prerequisites for visibility

- Parameter window [Configuration](#)
 - Parameter [Enable output X + Y](#) \ Option *Yes*
 - Parameter [Application](#) \ Option *Shutter Actuator*
- The parameter is in the parameter window [Shutter Actuator X+Y](#) \ parameter window [Shutter Actuator functions](#).

7.4.46 Enable function Automatic sun protection

This parameter enables the function *Automatic sun protection* and the related parameter window *Automatic sun protection* is displayed.

Option	
<i>No</i>	The function is not enabled.
<i>Yes</i>	The following dependent parameter windows are shown: <ul style="list-style-type: none"> • Automatic sun protection The following dependent Group Objects are displayed: <ul style="list-style-type: none"> • Activate/Deactivate Automatic sun protection • Sun

Prerequisites for visibility

- Parameter window [Configuration](#)
 - Parameter [Enable output X + Y](#) \ Option *Yes*
 - Parameter [Application](#) \ Option *Shutter Actuator*
- The parameter is in the parameter window [Shutter Actuator X+Y](#) \ parameter window [Shutter Actuator functions](#).

7.4.47 Enable function Scenes [Shutter Actuator]

This parameter enables the function *Scenes* and the related parameter window [Scene assignments \[Shutter Actuator\]](#) is displayed.

Option	
<i>No</i>	The function is not enabled.
<i>Yes</i>	The following dependent parameter windows are shown: <ul style="list-style-type: none"> • Scene assignments [Shutter Actuator] The following dependent Group Objects are displayed: <ul style="list-style-type: none"> • Scene 1 ... 64

Prerequisites for visibility

- Parameter window [Configuration](#)
 - Parameter [Enable output X + Y](#) \ Option *Yes*
 - Parameter [Application](#) \ Option *Shutter Actuator*
- The parameter is in the parameter window [Shutter Actuator X+Y](#) \ parameter window [Shutter Actuator functions](#).

7.4.48 Enable function Scenes [Switch Actuator]

This parameter enables the function *Scenes* and the related parameter window [Scene assignments \[Switch Actuator\]](#) is displayed.

Option	
<i>No</i>	The function is not enabled.
<i>Yes</i>	The following dependent parameter windows are shown: <ul style="list-style-type: none"> • Scene assignments [Switch Actuator] The following dependent Group Objects are displayed: <ul style="list-style-type: none"> • Scene 1 ... 64

Prerequisites for visibility

- Parameter window [Configuration](#)
 - Parameter [Enable output X + Y](#) \ Option *Yes*
 - Parameter [Application](#) \ Option *Switch Actuator*
- The parameter is in the parameter window [Switch Actuator X](#) \ parameter window [Functions Switch Actuator](#).

7.4.49 Enable function Time

This parameter enables one of the following time functions and the related parameter window is displayed:

- *Staircase lighting*
- *Delay for switching on and off*
- *Flashing*

Option	
<i>No</i>	No time function is used for this output.
<i>Staircase lighting</i>	<p>The <i>Staircase lighting</i> time function is used for this output.</p> <p>The following dependent parameter windows are shown:</p> <ul style="list-style-type: none"> • Staircase lighting <p>The following dependent Group Objects are displayed:</p> <ul style="list-style-type: none"> • Staircase lighting permanent on
<i>Delay for switching on and off</i>	<p>The time function <i>Delay for switching on and off</i> is used for this output.</p> <p>The following dependent parameter windows are shown:</p> <ul style="list-style-type: none"> • Delay for switching on and off
<i>Flashing</i>	<p>The <i>Flashing</i> time function is used for this output.</p> <p>The following dependent parameter windows are shown:</p> <ul style="list-style-type: none"> • Flashing <p>The following dependent Group Objects are displayed:</p> <ul style="list-style-type: none"> • Flashing

Prerequisites for visibility

- Parameter window [Configuration](#)
 - Parameter [Enable output X + Y](#) \ Option *Yes*
 - Parameter [Application](#) \ Option *Switch Actuator*
- The parameter is in the parameter window [Switch Actuator X](#) \ parameter window [Functions Switch Actuator](#).

7.4.50 Total duration for slat turning from 0 % - 100 %

This parameter is used to set the total duration for slat turning.

Note

The total duration for slat turning must be determined manually.

Note

The device cannot process times shorter than 50 ms.

Option
50 ... <u>1,500</u> ... 60,000 ms

Prerequisites for visibility

- Parameter window [Configuration](#)
 - Parameter [Enable output X + Y](#) \ Option *Yes*
 - Parameter [Application](#) \ Option *Shutter Actuator*
- Parameter window [Shutter Actuator X+Y](#) \ Parameter window [Shutter Actuator functions](#) \ Parameter [Operating mode](#) \ Option *Blind/Shutter control with slat adjustment*
- Parameter window [Shutter Actuator X+Y](#) \ Parameter window [Blind/Shutter](#)
 - Parameter [Parameter setting](#) \ Option *Individual*
 - Parameter [Determine slat adjustment time](#) \ Option *Via total duration for slat turning*
- The parameter is in the parameter window [Shutter Actuator X+Y](#) \ parameter window [Blind/Shutter](#).

7.4.51 In period (0 = deactivated)

This parameter is used to define the period during which the device sends telegrams. The telegrams are sent as quickly as possible at the start of a period.

i Note

The telegram rate limit is deactivated when the value 0 is selected.

More information: → [Telegram rate limit, Page 292](#).

Option

0 ... 1 ... 59 s

Prerequisites for visibility

- The parameter is in the parameter window [Configuration](#).

7.4.52 Enable Group Object "Block direct operation"

This parameter enables the Group Object [Block direct operation](#).

Option

<u>No</u>	The Group Object is not enabled.
Yes	The following dependent Group Objects are displayed: <ul style="list-style-type: none"> • Block direct operation

Prerequisites for visibility

- Parameter window [Configuration](#)
 - Parameter [Enable output X + Y](#) \ Option Yes
 - Parameter [Application](#) \ Option [Shutter Actuator](#)
- Parameter window [Shutter Actuator X+Y](#) \ Parameter window [Shutter Actuator functions](#) \ Parameter [Enable function Automatic sun protection](#) \ Option Yes
- Parameter window [Shutter Actuator X+Y](#) \ Parameter window [Automatic sun protection](#) \ Parameter [Parameter setting](#) \ Option [Individual](#)
- The parameter is in the parameter window [Shutter Actuator X+Y](#) \ parameter window [Automatic sun protection](#).

7.4.53 Enable Group Object "Frost alarm"

This parameter enables the Group Object [Frost alarm](#).

More information: → [Frost alarm, Page 89](#).

Option

<u>No</u>	The Group Object is not enabled.
Yes	The following dependent parameters are shown: <ul style="list-style-type: none"> • Cyclical monitoring • Blind/Shutter reaction on frost alarm The following dependent Group Objects are displayed: <ul style="list-style-type: none"> • Frost alarm

Prerequisites for visibility

- The parameter is in the parameter window [Safety/Weather alarms](#).

7.4.54 Enable Group Object "In operation"

This parameter enables the Group Object *In operation*.

Option	
<i>No</i>	The Group Object is not enabled.
<i>Yes, send value 0 cyclically</i>	<p>The Group Object is enabled and cyclically sends the value 0.</p> <p>The following dependent parameters are shown:</p> <ul style="list-style-type: none"> • Sending cycle <p>The following dependent Group Objects are displayed:</p> <ul style="list-style-type: none"> • In operation
<i>Yes, send value 1 cyclically</i>	<p>The Group Object is enabled and cyclically sends the value 1.</p> <p>The following dependent parameters are shown:</p> <ul style="list-style-type: none"> • Sending cycle <p>The following dependent Group Objects are displayed:</p> <ul style="list-style-type: none"> • In operation

Prerequisites for visibility

- The parameter is in the parameter window [Device settings](#).

7.4.55 Enable Group Object "Trigger reference movement"

This parameter enables the Group Object *Trigger reference movement*.

More information: → [reference movement, Page 286](#).

Option	
<i>No</i>	The Group Object is not enabled.
<i>Yes</i>	<p>The following dependent parameters are shown:</p> <ul style="list-style-type: none"> • Position after reference movement <p>The following dependent Group Objects are displayed:</p> <ul style="list-style-type: none"> • Trigger reference movement

Prerequisites for visibility

- Parameter window [Configuration](#)
 - Parameter [Enable output X + Y](#) \ Option *Yes*
 - Parameter [Application](#) \ Option *Shutter Actuator*
- Parameter window [Shutter Actuator X+Y](#) \ Parameter window [Drive](#) \ Parameter [Parameter setting](#) \ Option *Individual*
- The parameter is in the parameter window [Shutter Actuator X+Y](#) \ parameter window [Drive](#).

7.4.56 Enable Group Object "Rain alarm"

This parameter enables the Group Object *Rain alarm*.

More information: → [Rain alarm, Page 89](#).

Option	
<i>No</i>	The Group Object is not enabled.
<i>Yes</i>	<p>The following dependent parameters are shown:</p> <ul style="list-style-type: none"> • Cyclical monitoring • Blind/Shutter reaction on rain alarm <p>The following dependent Group Objects are displayed:</p> <ul style="list-style-type: none"> • Rain alarm

Prerequisites for visibility

- The parameter is in the parameter window [Safety/Weather alarms](#).

7.4.57 Enable Group Object "Safety priority x"

These parameters are used to enable the Group Objects *Safety priority x* (x = 1, 2, 3).

More information: → [Safety priority, Page 91](#).

Option	
<i>No</i>	The Group Object is not enabled.
<i>Yes</i>	The following dependent parameters are shown: <ul style="list-style-type: none"> • Cyclical monitoring The following dependent Group Objects are displayed: <ul style="list-style-type: none"> • Safety priority x

Prerequisites for visibility

- The parameter is in the parameter window [Safety/Weather alarms](#).

7.4.58 Enable Group Object "Block automatic sun protection"

This parameter enables the Group Object *Block Automatic sun protection*.

Option	
<i>No</i>	The Group Object is not enabled.
<i>Yes</i>	The following dependent Group Objects are displayed: <ul style="list-style-type: none"> • Block Automatic sun protection

Prerequisites for visibility

- Parameter window [Configuration](#)
 - Parameter [Enable output X + Y](#) \ Option *Yes*
 - Parameter [Application](#) \ Option *Shutter Actuator*
- Parameter window [Shutter Actuator X+Y](#) \ Parameter window [Shutter Actuator functions](#) \ Parameter [Enable function Automatic sun protection](#) \ Option *Yes*
- Parameter window [Shutter Actuator X+Y](#) \ Parameter window [Automatic sun protection](#) \ Parameter [Parameter setting](#) \ Option *Individual*
- The parameter is in the parameter window [Shutter Actuator X+Y](#) \ parameter window [Automatic sun protection](#).

7.4.59 Enable Group Object "Status Operability"

This parameter enables the Group Object *Status Operability*.

KNX operation is blocked under the following conditions:

- Safety functions active (weather alarm, block or forced operation)
- Operating mode *Manual operation* active
- KNX operation blocked via Group Object *Block direct operation*

Option

<i>No</i>	The Group Object is not enabled.
<i>Yes</i>	The following dependent parameters are shown: <ul style="list-style-type: none"> • <i>Send value of Group Object "Status Operability"</i> The following dependent Group Objects are displayed: <ul style="list-style-type: none"> • <i>Status Operability</i>

Prerequisites for visibility

- Parameter window *Configuration*
 - Parameter *Enable output X + Y* \ Option *Yes*
 - Parameter *Application* \ Option *Shutter Actuator*
- Parameter window *Shutter Actuator X+Y* \ Parameter window *status messages* \ Parameter *Parameter setting* \ Option *Individual*
- The parameter is in the parameter window *Shutter Actuator X+Y* \ parameter window *status messages*.

7.4.60 Enable Group Object "Status Result"

This parameter enables the Group Object *Status Result [Logic]*.

Option

<i>No</i>	The Group Object is not enabled.
<i>Yes</i>	The following dependent parameters are shown: <ul style="list-style-type: none"> • <i>Send value of Group Object "Status Result"</i> The following dependent Group Objects are displayed: <ul style="list-style-type: none"> • <i>Status Result [Logic]</i>

Prerequisites for visibility

- Parameter window *Configuration* \ Parameter *Enable Logic/Threshold x-y* \ Option *Yes*
- Parameter window *Logic/Threshold* \ Parameter window *Logic/Threshold x* \ Parameter *Function of the logic gate* \ Options *AND / OR / Exclusive OR / GATE / 1 bit Inverter*
- The parameter is in the parameter window *Logic/Threshold* \ parameter window *Logic/Threshold x*.

7.4.61 Enable group object "Status Load shedding"

This parameter enables the Group Object *Status Load shedding*.

Option	
<i>No</i>	The Group Object is not enabled.
<i>Yes</i>	The following dependent parameters are shown: <ul style="list-style-type: none"> • <i>Send value of Group Object "Status Load shedding"</i> The following dependent Group Objects are displayed: <ul style="list-style-type: none"> • <i>Status Load shedding</i>

Prerequisites for visibility

- Parameter window *Configuration*
 - Parameter *Enable output X + Y* \ Option *Yes*
 - Parameter *Application* \ Option *Switch Actuator*
- Parameter window *Device settings* \ Parameter *Enable central Group Object "Receive load shedding stage"* \ Option *Yes*
- Parameter window *Switch Actuator X* \ Parameter window *Functions Switch Actuator* \ Parameter *Enable function Load shedding* \ Option *Yes*
- Parameter window *Switch Actuator X* \ Parameter window *Load shedding* \ Parameter *Parameter setting* \ Option *Individual*
- The parameter is in the parameter window *Switch Actuator X* \ parameter window *Load shedding*.

7.4.62 Enable Group Object "Status Automatic sun protection"

This parameter enables the Group Object *Status Automatic sun protection*.

Option	
<i>No</i>	The Group Object is not enabled.
<i>Yes</i>	The following dependent parameters are shown: <ul style="list-style-type: none"> • <i>Send value of Group Object "Status Automatic sun protection"</i> The following dependent Group Objects are displayed: <ul style="list-style-type: none"> • <i>Status Automatic sun protection</i>

Prerequisites for visibility

- Parameter window *Configuration*
 - Parameter *Enable output X + Y* \ Option *Yes*
 - Parameter *Application* \ Option *Shutter Actuator*
- Parameter window *Shutter Actuator X+Y* \ Parameter window *Shutter Actuator functions* \ Parameter *Enable function Automatic sun protection* \ Option *Yes*
- Parameter window *Shutter Actuator X+Y* \ Parameter window *status messages* \ Parameter *Parameter setting* \ Option *Individual*
- The parameter is in the parameter window *Shutter Actuator X+Y* \ parameter window *status messages*.

7.4.63 Enable Group Object "Request status values"

This parameter enables the Group Object *Request status values*.

All status messages of the device can be requested using the Group Object *Request status values* and sent on the bus (ABB i-bus® KNX).

i Note

The values of the status Group Objects are sent only if sending on request is set in the related parameters.

Option

<i>No</i>	The Group Object is not enabled.
<i>Yes</i>	The following dependent Group Objects are displayed: <ul style="list-style-type: none"> <i>Request status values</i>

Prerequisites for visibility

- The parameter is in the parameter window *Device settings*.

7.4.64 Enable Group Object "Wind alarm x"

These parameters are used to enable the Group Objects *Wind alarm x* (x = 1, 2, 3).

More information: → [Wind alarm, Page 88](#).

Option

<i>No</i>	The Group Object is not enabled.
<i>Yes</i>	The following dependent parameters are shown: <ul style="list-style-type: none"> <i>Cyclical monitoring</i> <i>Output reacts to wind alarm x</i> <p>The following dependent Group Objects are displayed:</p> <ul style="list-style-type: none"> <i>Wind alarm x</i>

Prerequisites for visibility

- The parameter is in the parameter window *Safety/Weather alarms*.

7.4.65 Enable Group Objects "Move to position Height/Slat"

This parameter enables the Group Objects *Move to position height* and *Move to position slat*.

i Note

The Group Object *Move to position slat* is visible only in the operating mode *Blind/Shutter control with slat adjustment*.

Option

<i>No</i>	The Group Objects will not be enabled.
<i>Yes</i>	The following dependent Group Objects are displayed: <ul style="list-style-type: none"> <i>Move to position height</i> <i>Move to position slat</i>

Prerequisites for visibility

- Parameter window *Configuration*
 - Parameter *Enable output X + Y* \ Option *Yes*
 - Parameter *Application* \ Option *Shutter Actuator*
- Parameter window *Shutter Actuator X+Y* \ Parameter window *Blind/Shutter* \ Parameter *Parameter setting* \ Option *Individual*
- The parameter is in the parameter window *Shutter Actuator X+Y* \ parameter window *Blind/Shutter*.

7.4.66 Enable Group Objects "Status Upper/Lower end position"

This parameter enables the Group Objects *Status Upper end position* and *Status Lower end position*.

Option	
<i>No</i>	The Group Objects will not be enabled.
<i>Yes</i>	<p>The following dependent parameters are shown:</p> <ul style="list-style-type: none"> • <i>Send value of Group Objects "Status Upper/Lower end position"</i> <p>The following dependent Group Objects are displayed:</p> <ul style="list-style-type: none"> • <i>Status Upper end position</i> • <i>Status Lower end position</i>

Prerequisites for visibility

- Parameter window *Configuration*
 - Parameter *Enable output X + Y* \ Option *Yes*
 - Parameter *Application* \ Option *Shutter Actuator*
- Parameter window *Shutter Actuator X+Y* \ Parameter window *status messages* \ Parameter *Parameter setting* \ Option *Individual*
- The parameter is in the parameter window *Shutter Actuator X+Y* \ parameter window *status messages*.

7.4.67 Enable Group Objects "Status Result" and "Status Input value between thresholds"

This parameter enables the Group Objects *Status Result [Threshold]* and *Status Input value between thresholds*.

Option	
<i>No</i>	The Group Objects will not be enabled.
<i>Yes</i>	<p>The following dependent parameters are shown:</p> <ul style="list-style-type: none"> • <i>Send value of Group Object "Status Result"</i> <p>The following dependent Group Objects are displayed:</p> <ul style="list-style-type: none"> • <i>Status Result [Threshold]</i> • <i>Status Input value between thresholds</i>

Prerequisites for visibility

- Parameter window *Configuration* \ Parameter *Enable Logic/Threshold x-y* \ Option *Yes*
- Parameter window *Logic/Threshold* \ Parameter window *Logic/Threshold x* \ Parameter *Function of the logic gate* \ Option *Threshold*
- The parameter is in the parameter window *Logic/Threshold* \ parameter window *Logic/Threshold x*.

7.4.68 Enable Group Objects "Status Height/Slat"

This parameter enables the Group Objects *Status Height* and *Status Slat*.

i Note

The Group Object *Status Slat* is visible only in the operating mode *Blind/Shutter control with slat adjustment*.

Option

<i>No</i>	The Group Objects will not be enabled.
<i>Yes</i>	The following dependent parameters are shown: <ul style="list-style-type: none"> • <i>Send value of Group Objects "Status Height/Slat"</i> The following dependent Group Objects are displayed: <ul style="list-style-type: none"> • <i>Status Height</i> • <i>Status Slat</i>

Prerequisites for visibility

- Parameter window *Configuration*
 - Parameter *Enable output X + Y* \ Option *Yes*
 - Parameter *Application* \ Option *Shutter Actuator*
- Parameter window *Shutter Actuator X+Y* \ Parameter window *status messages* \ Parameter *Parameter setting* \ Option *Individual*
- The parameter is in the parameter window *Shutter Actuator X+Y* \ parameter window *status messages*.

7.4.69 Enable Group Objects "Status byte" [Shutter Actuator]

This parameter enables one of the following Group Objects:

- *Status byte all active priorities*
- *Status byte highest active priority*

Option

<i>No</i>	The Group Object is not enabled.
<i>Yes, all active priorities</i>	The following dependent parameters are shown: <ul style="list-style-type: none"> • <i>Send value of Group Objects "Status byte" [Shutter Actuator]</i> The following dependent Group Objects are displayed: <ul style="list-style-type: none"> • <i>Status byte all active priorities</i>
<i>Yes, highest active priority</i>	The following dependent parameters are shown: <ul style="list-style-type: none"> • <i>Send value of Group Objects "Status byte" [Shutter Actuator]</i> The following dependent Group Objects are displayed: <ul style="list-style-type: none"> • <i>Status byte highest active priority</i>

Prerequisites for visibility

- Parameter window *Configuration*
 - Parameter *Enable output X + Y* \ Option *Yes*
 - Parameter *Application* \ Option *Shutter Actuator*
- Parameter window *Shutter Actuator X+Y* \ Parameter window *status messages* \ Parameter *Parameter setting* \ Option *Individual*
- The parameter is in the parameter window *Shutter Actuator X+Y* \ parameter window *status messages*.

7.4.70 Enable Group Objects "Status byte" [Switch Actuator]

This parameter enables one of the following Group Objects:

- [Status byte all active priorities](#)
- [Status byte highest active priority](#)

Option	
<u>No</u>	The Group Object is not enabled.
<i>Yes, all active priorities</i>	<p>The following dependent parameters are shown:</p> <ul style="list-style-type: none"> • Send value of Group Objects "Status byte" [Switch Actuator] <p>The following dependent Group Objects are displayed:</p> <ul style="list-style-type: none"> • Status byte all active priorities
<i>Yes, highest active priority</i>	<p>The following dependent parameters are shown:</p> <ul style="list-style-type: none"> • Send value of Group Objects "Status byte" [Switch Actuator] <p>The following dependent Group Objects are displayed:</p> <ul style="list-style-type: none"> • Status byte highest active priority

Prerequisites for visibility

- Parameter window [Configuration](#)
 - Parameter [Enable output X + Y](#) \ Option [Yes](#)
 - Parameter [Application](#) \ Option [Switch Actuator](#)
- Parameter window [Switch Actuator X](#) \ Parameter window [Basic settings \[Switch Actuator\]](#) \ Parameter [Parameter setting](#) \ Option [Individual](#)
- The parameter is in the parameter window [Switch Actuator X](#) \ [Basic settings \[Switch Actuator\]](#).

7.4.71 Enable Time Group Objects for setting of device time

This parameter is used to define the data point type for the reception of the date and time. The corresponding Group Objects are enabled.

Option	
<u>No</u>	The Group Objects will not be enabled.
<i>Date (DPT 11.001)/time (10.001)</i>	<p>Date and time are sent via two separate Group Objects on the bus (ABB i-bus® KNX).</p> <p>The following dependent parameters are shown:</p> <ul style="list-style-type: none"> • Request Date/Time via Group Object <p>The following dependent Group Objects are displayed:</p> <ul style="list-style-type: none"> • Set date • Set time • Request Date/Time
<i>Date/Time (DPT 19.001)</i>	<p>Date and time are sent via a Group Object on the bus (ABB i-bus® KNX).</p> <p>The following dependent parameters are shown:</p> <ul style="list-style-type: none"> • Request Date/Time via Group Object <p>The following dependent Group Objects are displayed:</p> <ul style="list-style-type: none"> • Set date/time • Request Date/Time

Prerequisites for visibility

- The parameter is in the parameter window [Device settings](#).

7.4.72 Slat position after reaching lower end position (100 % = deactivated)

The slats are closed after the Blind/Shutter reaches the lower end position. This parameter is used to define a deviating slat position after reaching the lower end position.

- 100 %: The function is deactivated, the slats are closed
- 1 ... 99 %: The slats will be moved to the corresponding intermediate position
- 0 %: The slats are open

Option

0 ... 100 %

Prerequisites for visibility

- Parameter window [Configuration](#) \ Parameter [Enable output X + Y](#) \ Option Yes
- Parameter window [Shutter Actuator X+Y](#) \ Parameter window [Shutter Actuator functions](#)
 - Parameter [Application](#) \ Option [Shutter Actuator](#)
 - Parameter [Operating mode](#) \ Option [Blind/Shutter control with slat adjustment](#)
- Parameter window [Shutter Actuator X+Y](#) \ Parameter window [Blind/Shutter](#) \ Parameter [Parameter setting](#) \ Option [Individual](#)
- The parameter is in the parameter window [Shutter Actuator X+Y](#) \ parameter window [Blind/Shutter](#).

7.4.73 Determine slat adjustment time

This parameter is used to define how the time required to open or close the slats completely is set.

Option

Via duration of slat adjustment

The slat adjustment time is given by the settings in the following parameters:

- [Duration of slat adjustment/step](#)
- [Number of slat adjustments/steps \(from 0 % = open to 100 % = closed\)](#)

Refer to the motor's data sheet for the duration of a single slat adjustment.

The following dependent parameters are shown:

- [Duration of slat adjustment/step](#)

Via total duration for slat turning

The slat adjustment time is given by the settings in the following parameters:

- [Total duration for slat turning from 0 % - 100 %](#)
- [Number of slat adjustments/steps \(from 0 % = open to 100 % = closed\)](#)

The total duration for slat turning must be determined manually.

The following dependent parameters are shown:

- [Total duration for slat turning from 0 % - 100 %](#)
-

Prerequisites for visibility

- Parameter window [Configuration](#)
 - Parameter [Enable output X + Y](#) \ Option Yes
 - Parameter [Application](#) \ Option [Shutter Actuator](#)
- Parameter window [Shutter Actuator X+Y](#) \ Parameter window [Shutter Actuator functions](#) \ Parameter [Operating mode](#) \ Option [Blind/Shutter control with slat adjustment](#)
- Parameter window [Shutter Actuator X+Y](#) \ Parameter window [Blind/Shutter](#) \ Parameter [Parameter setting](#) \ Option [Individual](#)
- The parameter is in the parameter window [Shutter Actuator X+Y](#) \ parameter window [Blind/Shutter](#).

7.4.74 Load shedding stage

This parameter is used to assign the channel to a load shedding stage.

Option

1... 15

Prerequisites for visibility

- Parameter window [Configuration](#)
 - Parameter [Enable output X + Y](#) \ Option *Yes*
 - Parameter [Application](#) \ Option *Switch Actuator*
- Parameter window [Device settings](#) \ Parameter [Enable central Group Object "Receive load shedding stage"](#) \ Option *Yes*
- Parameter window [Switch Actuator X](#) \ Parameter window [Functions Switch Actuator](#) \ Parameter [Enable function Load shedding](#) \ Option *Yes*
- Parameter window [Switch Actuator X](#) \ Parameter window [Load shedding](#) \ Parameter [Parameter setting](#) \ Option *Individual*
- The parameter is in the parameter window [Switch Actuator X](#) \ parameter window [Load shedding](#).

7.4.75 Overwrite load shedding stage at download

This parameter is used to define whether the load shedding stage assigned to the channel is overwritten while downloading the application to the device.

Option

<i>No</i>	The existing values in the device are not overwritten.
<i>Yes</i>	The existing values in the device are overwritten with the values defined in ETS.

Prerequisites for visibility

- Parameter window [Configuration](#)
 - Parameter [Enable output X + Y](#) \ Option *Yes*
 - Parameter [Application](#) \ Option *Switch Actuator*
- Parameter window [Device settings](#) \ Parameter [Enable central Group Object "Receive load shedding stage"](#) \ Option *Yes*
- Parameter window [Switch Actuator X](#) \ Parameter window [Functions Switch Actuator](#) \ Parameter [Enable function Load shedding](#) \ Option *Yes*
- Parameter window [Switch Actuator X](#) \ Parameter window [Load shedding](#)
 - Parameter [Parameter setting](#) \ Option *Individual*
 - Parameter [Change load shedding stage via Group Object](#) \ Option *Yes*
 - or
 - Parameter [Change load shedding stage via i-bus® Tool](#) \ Option *Yes*
- The parameter is in the parameter window [Switch Actuator X](#) \ parameter window [Load shedding](#).

7.4.76 Change load shedding stage via i-bus® Tool

This parameter is used to define whether the load shedding stage assigned to the channel can be changed via i-bus® Tool.

i Note

The interface to i-bus® Tool is available from the following software versions:

- Application from V1.2
- Firmware from V0.2.0

Option

<i>No</i>	The load shedding stage cannot be changed via i-bus® Tool.
<i>Yes</i>	The following dependent parameters are shown: <ul style="list-style-type: none"> • Overwrite load shedding stage at download

Prerequisites for visibility

- Parameter window [Configuration](#)
 - Parameter [Enable output X + Y](#) \ Option *Yes*
 - Parameter [Application](#) \ Option *Switch Actuator*
- Parameter window [Device settings](#) \ Parameter [Enable central Group Object "Receive load shedding stage"](#) \ Option *Yes*
- Parameter window [Switch Actuator X](#) \ Parameter window [Functions Switch Actuator](#) \ Parameter [Enable function Load shedding](#) \ Option *Yes*
- Parameter window [Switch Actuator X](#) \ Parameter window [Load shedding](#) \ Parameter [Parameter setting](#) \ Option *Individual*
- The parameter is in the parameter window [Switch Actuator X](#) \ parameter window [Load shedding](#).

7.4.77 Change load shedding stage via Group Object

This parameter is used to define whether the load shedding stage assigned to the channel can be changed via the Group Object [Set load shedding stage](#).

Option

<i>No</i>	The load shedding stage cannot be changed via a Group Object.
<i>Yes</i>	The following dependent parameters are shown: <ul style="list-style-type: none"> • Overwrite load shedding stage at download <p>The following dependent Group Objects are displayed:</p> <ul style="list-style-type: none"> • Set load shedding stage

Prerequisites for visibility

- Parameter window [Configuration](#)
 - Parameter [Enable output X + Y](#) \ Option *Yes*
 - Parameter [Application](#) \ Option *Switch Actuator*
- Parameter window [Device settings](#) \ Parameter [Enable central Group Object "Receive load shedding stage"](#) \ Option *Yes*
- Parameter window [Switch Actuator X](#) \ Parameter window [Functions Switch Actuator](#) \ Parameter [Enable function Load shedding](#) \ Option *Yes*
- Parameter window [Switch Actuator X](#) \ Parameter window [Load shedding](#) \ Parameter [Parameter setting](#) \ Option *Individual*
- The parameter is in the parameter window [Switch Actuator X](#) \ parameter window [Load shedding](#).

7.4.78 Enable Logic/Threshold x-y

This parameter enables the functions *Logic* and *Threshold* in groups of four.

The functions *Logic* and *Threshold* are configured in the parameter window [Logic/Threshold x](#).

The functions *Logic* and *Threshold* can be used independently or linked with an output.

More information → [Function Logic, Page 93](#), → [Function Threshold, Page 94](#).

i Note

The default value is dependent on the product variant and does not apply to all logic and threshold groups.

Option

<i>No</i>	The functions <i>Logic</i> and <i>Threshold</i> are not enabled.
<u><i>Yes</i></u>	The following dependent parameter windows are shown: <ul style="list-style-type: none"> • Logic/Threshold • Logic/Threshold x

Prerequisites for visibility

- The parameter is in the parameter window [Configuration](#).

7.4.79 Enable manual operation

This parameter is used to enable the manual operation of the device.

More information: → [Manual operation, Page 277](#).

Option

<i>No</i>	The manual operation of the device is not enabled.
<u><i>Yes</i></u>	The following dependent parameters are shown: <ul style="list-style-type: none"> • Automatic reset from manual operation to KNX operation • State after end of manual operation <p>The following dependent Group Objects are displayed:</p> <ul style="list-style-type: none"> • Enable/Block manual operation • Ending manual operation • Status Manual operation

Prerequisites for visibility

- The parameter is in the parameter window [Manual operation](#).

7.4.80 Maximum number of sent telegrams

This parameter is used to define the number of telegrams sent within a period that can be set.

The period is defined in the parameter → [In period \(0 = deactivated\), Page 181](#).

More information: → [Telegram rate limit, Page 292](#).

Option

3... 20... 100

Prerequisites for visibility

- The parameter is in the parameter window [Configuration](#).

7.4.81 Min. duration of the overshoot

This parameter is used to define how long the value received at the threshold input must exceed the threshold before the result of the function *Threshold* is updated.

Option

00:00:00... 18:12:15 hh:mm:ss

Prerequisites for visibility

- Parameter window [Configuration](#) \ Parameter [Enable Logic/Threshold x-y](#) \ Option Yes
- Parameter window [Logic/Threshold](#) \ Parameter window [Logic/Threshold x](#) \ Parameter [Function of the logic gate](#) \ Option *Threshold*
- The parameter is in the parameter window [Logic/Threshold](#) \ parameter window [Logic/Threshold x](#).

7.4.82 Min. duration of the undershoot

This parameter is used to define how long the value received at the threshold input must undershoot the threshold before the result of the function *Threshold* is updated.

Option

00:00:00... 18:12:15 hh:mm:ss

Prerequisites for visibility

- Parameter window [Configuration](#) \ Parameter [Enable Logic/Threshold x-y](#) \ Option Yes
- Parameter window [Logic/Threshold](#) \ Parameter window [Logic/Threshold x](#) \ Parameter [Function of the logic gate](#) \ Option *Threshold*
- The parameter is in the parameter window [Logic/Threshold](#) \ parameter window [Logic/Threshold x](#).

7.4.83 Minimum run time for drive



CAUTION

Setting a minimum run time that is too short can damage the connected drive.

- ▶ Observe the technical data of the connected drive.

This parameter is used to set the minimum run time for the drive.

Option

40 ... 50 ... 600 ms

Prerequisites for visibility

- Parameter window [Configuration](#) \
 - Parameter [Enable output X + Y](#) \ Option Yes
 - Parameter [Application](#) \ Option *Shutter Actuator*
- Parameter window [Shutter Actuator X+Y](#) \ Parameter window [Drive](#)
 - Parameter [Parameter setting](#) \ Option *Individual*
 - Parameter [Delay time for drive](#) \ Option *User-defined*
- The parameter is in the parameter window [Shutter Actuator X+Y](#) \ parameter window [Drive](#).

7.4.84 Minimum dwell time between the thresholds

This parameter is used to define how long the value received at the threshold input must be between the thresholds before an evaluation occurs.

Option

00:00:00... 18:12:15 hh:mm:ss

Prerequisites for visibility

- Parameter window [Configuration](#) \ Parameter [Enable Logic/Threshold x-y](#) \ Option Yes
- Parameter window [Logic/Threshold](#) \ Parameter window [Logic/Threshold x](#)
 - Parameter [Function of the logic gate](#) \ Option *Threshold*
 - Parameter [Monitor range between thresholds](#) \ Option Yes
- The parameter is in the parameter window [Logic/Threshold](#) \ parameter window [Logic/Threshold x](#).

7.4.85 Upper limit (0 % = top; 100 % = bottom)

This parameter is used to define the upper limit for the travel range limit.

More information: → [Travel range limit, Page 288](#).

Option

0... 100 %

Prerequisites for visibility

- Parameter window [Configuration](#) \
 - Parameter [Enable output X + Y](#) \ Option Yes
 - Parameter [Application](#) \ Option *Shutter Actuator*
- Parameter window [Shutter Actuator X+Y](#) \ Parameter window [Blind/Shutter](#)
 - Parameter [Parameter setting](#) \ Option *Individual*
 - Parameter [Limit travel range via Group Object](#) \ Options *Move Blind/Shutter Up/Down limited / Activate limitation*
- The parameter is in the parameter window [Shutter Actuator X+Y](#) \ parameter window [Blind/Shutter](#).

7.4.86 Upper limit valid for direct commands

This parameter is used to define whether the upper travel range limit applies to direct commands.

More information → [Direct operation, Page 102](#), → [Travel range limit, Page 288](#).

Option

No

Yes

Prerequisites for visibility

- Parameter window [Configuration](#) \
 - Parameter [Enable output X + Y](#) \ Option Yes
 - Parameter [Application](#) \ Option *Shutter Actuator*
- Parameter window [Shutter Actuator X+Y](#) \ Parameter window [Blind/Shutter](#)
 - Parameter [Parameter setting](#) \ Option *Individual*
 - Parameter [Limit travel range via Group Object](#) \ Option *Activate limitation*
- The parameter is in the parameter window [Shutter Actuator X+Y](#) \ parameter window [Blind/Shutter](#).

7.4.87 Upper limit valid for Automatic sun protection commands

This parameter is used to define whether the upper travel range limit applies to Automatic sun protection commands.

More information → [Function Automatic sun protection, Page 100](#), → [Travel range limit, Page 288](#).

Option	
<i>No</i>	
<i>Yes</i>	

Prerequisites for visibility

- Parameter window [Configuration](#) \
 - Parameter [Enable output X + Y](#) \ Option *Yes*
 - Parameter [Application](#) \ Option *Shutter Actuator*
- Parameter window [Shutter Actuator X+Y](#) \ Parameter window [Blind/Shutter](#)
 - Parameter [Parameter setting](#) \ Option *Individual*
 - Parameter [Limit travel range via Group Object](#) \ Option *Activate limitation*
- The parameter is in the parameter window [Shutter Actuator X+Y](#) \ parameter window [Blind/Shutter](#).

7.4.88 Upper threshold

This parameter is used to define the upper threshold. Default values and units depend on the option selected in the [Data point type of Group Object "Threshold input"](#) parameter.

Option	
<i>0 ... 50 ... 100 %</i>	Upper threshold on selection of DPT 5.001.
<i>0 ... 200 ... 255</i>	Upper threshold on selection of DPT 5.010.
<i>0 ... 40000 ... 65535</i>	Upper threshold on selection of DPT 7.001.
<i>-100 ... 22 ... 250 °C</i>	Upper threshold on selection of DPT 9.001.
<i>0 ... 400 ... 100,000 lux</i>	Upper threshold on selection of DPT 9.004.
<i>0 ... 16000 ... 240000 mA</i>	Upper threshold on selection of DPT 9.021.
<i>0 ... 16 ... 24 A</i>	Upper threshold on selection of DPT 14.019.
<i>0 ... 4000 ... 10000 W</i>	Upper threshold on selection of DPT 14.056.
<i>0 ... 3 ... 10 kW</i>	Upper threshold on selection of DPT 9.024.
<i>0 ... 100000 ... 2147483647 Wh</i>	Upper threshold on selection of DPT 13.010.
<i>0 ... 70 ... 2147483647 kWh</i>	Upper threshold on selection of DPT 13.013.

Prerequisites for visibility

- Parameter window [Configuration](#) \ Parameter [Enable Logic/Threshold x-y](#) \ Option *Yes*
- Parameter window [Logic/Threshold](#) \ Parameter window [Logic/Threshold x](#) \ Parameter [Function of the logic gate](#) \ Option *Threshold*
- The parameter is in the parameter window [Logic/Threshold](#) \ parameter window [Logic/Threshold x](#).

7.4.89 Parameter setting

This parameter is used to define whether the settings for the parameter window are adopted from the template or each parameter is set individually.

Option	
<i>Apply from template</i>	The settings for the parameters are adopted from the template.
<i>Individual</i>	The parameters can be set individually.

Prerequisites for visibility

- The parameter appears at various points in the application. The visibility is dependent on the application and the higher-level parameter.

7.4.90 Move to position

This parameter is used to define how the Blind/Shutter is moved to the target position.

More information: → [Direct and indirect movement to the position, Page 287](#).

Option	
<i>Direct</i>	The Blind/Shutter is moved directly to the target position.
<i>Indirectly via upper end position</i>	The Blind/Shutter is moved to the upper end position first, then to the target position.
<i>Indirectly via lower end position</i>	The Blind/Shutter is moved to the lower end position first, then to the target position.
<i>Indirectly via shortest way</i>	The Blind/Shutter is moved to the closer end position first, then to the target position.

Prerequisites for visibility

- Parameter window [Configuration](#)
 - Parameter [Enable output X + Y](#) \ Option *Yes*
 - Parameter [Application](#) \ Option *Shutter Actuator*
- Parameter window [Shutter Actuator X+Y](#) \ Parameter window [Blind/Shutter](#) \ Parameter [Parameter setting](#) \ Option *Individual*
- The parameter is in the parameter window [Shutter Actuator X+Y](#) \ parameter window [Blind/Shutter](#).

7.4.91 Position height (0 % = top; 100 % = bottom)

This parameter is used to define the position to which the Blind/Shutter is moved.

Note

The possible options and default values depend on the higher-level parameter.

Option	
<i>0 ... 100 %</i>	
<i>0 ...50...100 %</i>	

Prerequisites for visibility

- The parameter appears at various points in the application. The visibility is dependent on the application and the higher-level parameter.

7.4.92 Position slat (0 % = open; 100 % = closed)

Note

This parameter is only visible if the option [Blind/Shutter control with slat adjustment](#) is set in the parameter [Operating mode](#).

This parameter is used to define the position to which the slats of the Blind/Shutter are moved.

Note

The possible options and default values depend on the higher-level parameter.

Option	
<i>0 ... 100 %</i>	
<i>0 ...50...100 %</i>	

Prerequisites for visibility

- The parameter appears at various points in the application. The visibility is dependent on the application and the higher-level parameter.

7.4.93 Position after reference movement

This parameter is used to define the Blind/Shutter position after a reference movement.

Option	
<i>No reaction, remain in reference position</i>	The Blind/Shutter remains in the "Upper end position" or "Lower end position" as the reference position.
<i>Move to position before reference movement</i>	The Blind/Shutter is moved to the position it was in before the reference movement.

Prerequisites for visibility

- Parameter window [Configuration](#)
 - Parameter [Enable output X + Y](#) \ Option *Yes*
 - Parameter [Application](#) \ Option *Shutter Actuator*
- Parameter window [Shutter Actuator X+Y](#) \ Parameter window [Drive](#)
 - Parameter [Parameter setting](#) \ Option *Individual*
 - Parameter [Enable Group Object "Trigger reference movement"](#) \ Option *Yes*
- The parameter is in the parameter window [Shutter Actuator X+Y](#) \ parameter window [Drive](#).

7.4.94 Order of priority for weather alarms

This parameter is used to define the order of priority of the weather alarms. If several weather alarms are active at the same time, only the weather alarm with the highest priority is executed.

Option	
<i>1.Wind alarm – 2.Rain alarm – 3.Frost alarm</i>	
<i>1.Wind alarm – 2.Frost alarm 3. - Rain alarm</i>	
<i>1.Rain alarm - 2.Wind alarm - 3.Frost alarm</i>	
<i>1.Rain alarm - 2.Frost alarm - 3.Wind alarm</i>	
<i>1.Frost alarm - 2.Wind alarm - 3.Rain alarm</i>	
<i>1.Frost alarm - 2.Rain alarm - 3.Wind alarm</i>	

Prerequisites for visibility

- The parameter is in the parameter window [Safety/Weather alarms](#).

7.4.95 Order of priority of weather alarm, block and forced operation

This parameter is used to define the order of priority of the safety functions. If several safety functions are active at the same time, only the safety function with the highest priority is executed.

Option
<i>1.Weather alarm - 2.Block - 3.Forced operation</i>
<i>1.Weather alarm – 2.Forced operation – 3.Block</i>
<i>1.Block – 2.Weather alarm – 3.Forced operation</i>
<i>1.Block – 2.Forced operation – 3.Weather alarm</i>
<i>1.Forced operation - 2.Weather alarm - 3.Block</i>
<i>1.Forced operation - 2.Block - 3.Weather alarm</i>

Prerequisites for visibility

- Parameter window *Configuration*
 - Parameter *Enable output X + Y* \ Option *Yes*
 - Parameter *Application* \ Option *Shutter Actuator*
- Parameter window *Shutter Actuator X+Y* \ Parameter window *Shutter Actuator functions* \ Parameter *Enable function Safety/Weather alarms* \ Option *Yes*
- Parameter window *Shutter Actuator X+Y* \ Parameter window *Safety/Weather alarms* \ Parameter *Parameter setting* \ Option *Individual*
- The parameter is in the parameter window *Shutter Actuator X+Y* \ parameter window *Safety/Weather alarms*.

7.4.96

Feedback of contact position via Group Object "Status Switch"

This parameter is used to define whether the position of the relay contact is signaled via the Group Object *Status Switch*.

Option	
<i>No</i>	The position of the relay contact is not signaled.
<i>Yes</i>	The following dependent parameters are shown: <ul style="list-style-type: none"> • <i>Value of Group Object "Status Switch"</i> • <i>Send value of Group Object "Status Switch"</i> The following dependent Group Objects are displayed: <ul style="list-style-type: none"> • <i>Status Switch</i>

Prerequisites for visibility

- Parameter window *Configuration*
 - Parameter *Enable output X + Y* \ Option *Yes*
 - Parameter *Application* \ Option *Switch Actuator*
- Parameter window *Switch Actuator X* \ Parameter window *Basic settings [Switch Actuator]* \ Parameter *Parameter setting* \ Option *Individual*
- The parameter is in the parameter window *Switch Actuator X* \ *Basic settings [Switch Actuator]*.

7.4.97

Switch output reacts to central Switch Group Object

This parameter can be used to define whether the output can be switched via the central Group Object *Switch*.

Option
<i>No</i>
<i>Yes</i>

Prerequisites for visibility

- Parameter window *Configuration*
 - Parameter *Enable output X + Y* \ Option *Yes*
 - Parameter *Application* \ Option *Switch Actuator*
- Parameter window *Device settings* \ Parameter *Enable central Group Object "Switch"* \ Option *Yes*
- Parameter window *Switch Actuator X* \ Parameter window *Basic settings [Switch Actuator]* \ Parameter *Parameter setting* \ Option *Individual*
- The parameter is in the parameter window *Switch Actuator X* \ *Basic settings [Switch Actuator]*.

7.4.98 Switching reaction on active load shedding stage

This parameter is used to define the position of the relay contact if a load shedding stage is activated.

i Note

Whether the relay contact is opened or closed depends on the setting in the parameter [Reaction of output](#).

Option

<i>Off</i>	Parameterization as normally closed contact: The relay contact is closed. Parameterization as normally open contact: The relay contact is opened.
<i>On</i>	Parameterization as normally closed contact: The relay contact is opened. Parameterization as normally open contact: The relay contact is closed.

Prerequisites for visibility

- Parameter window [Configuration](#)
 - Parameter [Enable output X + Y](#) \ Option *Yes*
 - Parameter [Application](#) \ Option *Switch Actuator*
- Parameter window [Device settings](#) \ Parameter [Enable central Group Object "Receive load shedding stage"](#) \ Option *Yes*
- Parameter window [Switch Actuator X](#) \ Parameter window [Functions Switch Actuator](#) \ Parameter [Enable function Load shedding](#) \ Option *Yes*
- Parameter window [Switch Actuator X](#) \ Parameter window [Load shedding](#) \ Parameter [Parameter setting](#) \ Option *Individual*
- The parameter is in the parameter window [Switch Actuator X](#) \ parameter window [Load shedding](#).

7.4.99 Switching reaction on bus voltage failure

This parameter is used to define the reaction of the relay contact on bus voltage failure.

i Note

The safety functions have priority over all other functions and priorities.
More information: → [Priorities, Page 281](#).

Option

<i>Contact unchanged</i>	The position of the relay contact remains unchanged.
<i>Contact open</i>	The relay contact is open if no safety function is active.
<i>Contact closed</i>	The relay contact is closed if no safety function is active.

Prerequisites for visibility

- Parameter window [Configuration](#)
 - Parameter [Enable output X + Y](#) \ Option *Yes*
 - Parameter [Application](#) \ Option *Switch Actuator*
- Parameter window [Switch Actuator X](#) \ Parameter window [Basic settings \[Switch Actuator\]](#) \ Parameter [Parameter setting](#) \ Option *Individual*
- The parameter is in the parameter window [Switch Actuator X](#) \ [Basic settings \[Switch Actuator\]](#).

7.4.100 Switching reaction on revoke of load shedding stage

This parameter is used to define the position of the relay contact if a load shedding stage is revoked.

i Note

Whether the relay contact is opened or closed depends on the setting in the parameter [Reaction of output](#).

Option	
No reaction	The position of the relay contact remains unchanged.
On	Parameterization as normally closed contact: The relay contact is opened. Parameterization as normally open contact: The relay contact is closed.
Off	Parameterization as normally closed contact: The relay contact is closed. Parameterization as normally open contact: The relay contact is opened.
Refreshed KNX state	The refreshed KNX state is used. → Refreshed KNX state, Page 291

Prerequisites for visibility

- Parameter window [Configuration](#)
 - Parameter [Enable output X + Y](#) \ Option [Yes](#)
 - Parameter [Application](#) \ Option [Switch Actuator](#)
- Parameter window [Device settings](#) \ Parameter [Enable central Group Object "Receive load shedding stage"](#) \ Option [Yes](#)
- Parameter window [Switch Actuator X](#) \ Parameter window [Functions Switch Actuator](#) \ Parameter [Enable function Load shedding](#) \ Option [Yes](#)
- Parameter window [Switch Actuator X](#) \ Parameter window [Load shedding](#) \ Parameter [Parameter setting](#) \ Option [Individual](#)
- The parameter is in the parameter window [Switch Actuator X](#) \ parameter window [Load shedding](#).

7.4.101 Switching reaction on cancellation of block, forced operation and safety priority

This parameter is used to define the relay contact position after cancellation of safety functions (safety priorities, block or forced operation).

i Note

Whether the relay contact is opened or closed depends on the setting in the parameter [Reaction of output](#).

Option	
No reaction	The position of the relay contact remains unchanged.
On	Parameterization as normally closed contact: The relay contact is opened. Parameterization as normally open contact: The relay contact is closed.
Off	Parameterization as normally closed contact: The relay contact is closed. Parameterization as normally open contact: The relay contact is opened.
Refreshed KNX state	The refreshed KNX state is used. → Refreshed KNX state, Page 291

Prerequisites for visibility

- Parameter window [Configuration](#)
 - Parameter [Enable output X + Y](#) \ Option [Yes](#)
 - Parameter [Application](#) \ Option [Switch Actuator](#)
- Parameter window [Switch Actuator X](#) \ Parameter window [Functions Switch Actuator](#) \ Parameter [Enable function Safety](#) \ Option [Yes](#)
- Parameter window [Switch Actuator X](#) \ Parameter window [Safety](#) \ Parameter [Parameter setting](#) \ Option [Individual](#)
- The parameter is in the parameter window [Switch Actuator X](#) \ parameter window [Safety](#).

7.4.102 Switching reaction on safety priority x

This parameter is used to define the position of the relay contact for a safety priority. The relay contact is switched to the defined position and blocked.

i Note

Whether the relay contact is opened or closed depends on the setting in the parameter *Reaction of output*.

More information: → [Safety priority, Page 91](#).

i Note

If a safety priority is active, the operation of the output via Group Objects, manual operation and i-bus® Tool is blocked.

Higher-priority safety functions continue to run → [Function diagram Switch Actuator, Page 87](#).

Option	
<i>No reaction/deactivated</i>	The position of the relay contact remains unchanged. The output does not react to the safety priority.
<i>On</i>	Parameterization as normally closed contact: The relay contact is opened. Parameterization as normally open contact: The relay contact is closed.
<i>Off</i>	Parameterization as normally closed contact: The relay contact is closed. Parameterization as normally open contact: The relay contact is opened.
<i>Unchanged (block)</i>	The relay contact is blocked in the current position.

Prerequisites for visibility

- Parameter window *Configuration*
 - Parameter *Enable output X + Y* \ Option *Yes*
 - Parameter *Application* \ Option *Switch Actuator*
- Parameter window *Safety/Weather alarms* \ Parameter *Enable Group Object "Safety priority x"* \ Option *Yes*
- Parameter window *Switch Actuator X* \ Parameter window *Functions Switch Actuator* \ Parameter *Enable function Safety* \ Option *Yes*
- Parameter window *Switch Actuator X* \ Parameter window *Safety* \ Parameter *Parameter setting* \ Option *Individual*
- The parameter is in the parameter window *Switch Actuator X* \ parameter window *Safety*.

7.4.103 Switching reaction on block

This parameter is used to define the position of the relay contact if blocked. The relay contact is switched to the defined position and blocked.

i Note

Whether the relay contact is opened or closed depends on the setting in the parameter *Reaction of output*.

More information: → [Block, Page 92](#).

i Note

If the safety function is active, the operation of the output via Group Objects, manual operation and i-bus® Tool is blocked.

Higher-priority safety functions continue to run.

→ [Function diagram Shutter Actuator, Page 86](#)

→ [Function diagram Switch Actuator, Page 87](#)

Option	
<i>No reaction/deactivated</i>	The function <i>Block</i> is deactivated.
<i>On</i>	Parameterization as normally closed contact: The relay contact is opened. Parameterization as normally open contact: The relay contact is closed. The following dependent Group Objects are displayed: <ul style="list-style-type: none"> • Block
<i>Off</i>	Parameterization as normally closed contact: The relay contact is closed. Parameterization as normally open contact: The relay contact is opened. The following dependent Group Objects are displayed: <ul style="list-style-type: none"> • Block
<i>Unchanged (block)</i>	The relay contact is blocked in the current position. The following dependent Group Objects are displayed: <ul style="list-style-type: none"> • Block

Prerequisites for visibility

- Parameter window [Configuration](#)
 - Parameter [Enable output X + Y](#) \ Option *Yes*
 - Parameter [Application](#) \ Option *Switch Actuator*
- Parameter window [Switch Actuator X](#) \ Parameter window [Functions Switch Actuator](#) \ Parameter [Enable function Safety](#) \ Option *Yes*
- Parameter window [Switch Actuator X](#) \ Parameter window [Safety](#) \ Parameter [Parameter setting](#) \ Option *Individual*
- The parameter is in the parameter window [Switch Actuator X](#) \ parameter window [Safety](#).

7.4.104 Switching reaction on forced operation

This parameter is used to define the position of the relay contact during forced operation. The relay contact is switched to the defined position and blocked.

i Note

Whether the relay contact is opened or closed depends on the setting in the parameter [Reaction of output](#).

More information: → [forced operation](#), Page 92.

i Note

If the safety function is active, the operation of the output via Group Objects, manual operation and i-bus® Tool is blocked.

Higher-priority safety functions continue to run.

→ [Function diagram Shutter Actuator](#), Page 86

→ [Function diagram Switch Actuator](#), Page 87

Option	
<i>On</i>	Parameterization as normally closed contact: The relay contact is opened. Parameterization as normally open contact: The relay contact is closed.
<i>Off</i>	Parameterization as normally closed contact: The relay contact is closed. Parameterization as normally open contact: The relay contact is opened.
<i>Unchanged (block)</i>	The relay contact is blocked in the current position.

Prerequisites for visibility

- Parameter window [Configuration](#)
 - Parameter [Enable output X + Y](#) \ Option *Yes*
 - Parameter [Application](#) \ Option *Switch Actuator*
- Parameter window [Switch Actuator X](#) \ Parameter window [Functions Switch Actuator](#) \ Parameter [Enable function Safety](#) \ Option *Yes*
- Parameter window [Switch Actuator X](#) \ Parameter window [Safety](#)
 - Parameter [Parameter setting](#) \ Option *Individual*
 - Parameter [Forced operation \(1 bit / 2 bit\) \[Switch Actuator\]](#) \ Options *Activated 1 bit – 0 active / Activated 1 bit – 1 active*
- The parameter is in the parameter window [Switch Actuator X](#) \ parameter window [Safety](#).

7.4.105 Overwrite thresholds on download

This parameter is used to define whether the thresholds are overwritten while downloading the application to the device.

Option	
<i>No</i>	The existing values in the device are not overwritten.
<i>Yes</i>	The existing values in the device are overwritten with the values defined in ETS.

Prerequisites for visibility

- Parameter window [Configuration](#) \ Parameter [Enable Logic/Threshold x-y](#) \ Option *Yes*
- Parameter window [Logic/Threshold](#) \ Parameter window [Logic/Threshold x](#)
 - Parameter [Function of the logic gate](#) \ Option *Threshold*
 - Parameter [Change thresholds via Group Objects](#) \ Option *Yes*
 - or
 - Parameter [Change thresholds via i-bus® Tool](#) \ Option *Yes*
- The parameter is in the parameter window [Logic/Threshold](#) \ parameter window [Logic/Threshold x](#).

7.4.106 Change thresholds via i-bus® Tool

This parameter is used to define whether thresholds set in ETS can be changed via i-bus® Tool.

i Note

The interface to i-bus® Tool is available from the following software versions:

- Application from V1.2
- Firmware from V0.2.0

Option

Prerequisites for visibility

- Parameter window *Configuration* \ Parameter *Enable Logic/Threshold x-y* \ Option *Yes*
- Parameter window *Logic/Threshold* \ Parameter window *Logic/Threshold x* \ Parameter *Function of the logic gate* \ Option *Threshold*
- The parameter is in the parameter window *Logic/Threshold* \ parameter window *Logic/Threshold x*.

7.4.107 Change thresholds via Group Objects

This parameter is used to define whether the thresholds set in ETS can be changed via the corresponding Group Objects.

Option

<i>No</i>	The values cannot be changed via Group Objects.
<i>Yes</i>	<p>The values can be changed via Group Objects. Depending on the setting in the parameter <i>Data point type of Group Object "Threshold input"</i>, the following Group Objects are displayed:</p> <ul style="list-style-type: none"> • <i>Change upper threshold</i> (DPT 13.010) • <i>Change lower threshold</i> (DPT 13.010) • <i>Change upper threshold</i> (DPT 13.013) • <i>Change lower threshold</i> (DPT 13.013) • <i>Change upper threshold</i> (DPT 14.019) • <i>Change lower threshold</i> (DPT 14.019) • <i>Change upper threshold</i> (DPT 14.056) • <i>Change upper threshold</i> (DPT 14.056) • <i>Change upper threshold</i> (DPT 5.001) • <i>Change lower threshold</i> (DPT 5.001) • <i>Change upper threshold</i> (DPT 5.010) • <i>Change lower threshold</i> (DPT 5.010) • <i>Change upper threshold</i> (DPT 7.001) • <i>Change lower threshold</i> (DPT 7.001) • <i>Change upper threshold</i> (DPT 9.001) • <i>Change lower threshold</i> (DPT 9.001) • <i>Change upper threshold</i> (DPT 9.004) • <i>Change lower threshold</i> (DPT 9.004) • <i>Change upper threshold</i> (DPT 9.021) • <i>Change lower threshold</i> (DPT 9.021) • <i>Change upper threshold</i> (DPT 9.024) • <i>Change lower threshold</i> (DPT 9.024) <p>The following dependent parameters are shown:</p> <ul style="list-style-type: none"> • <i>Overwrite thresholds on download</i>

Prerequisites for visibility

- Parameter window *Configuration* \ Parameter *Enable Logic/Threshold x-y* \ Option *Yes*
- Parameter window *Logic/Threshold* \ Parameter window *Logic/Threshold x* \ Parameter *Function of the logic gate* \ Option *Threshold*
- The parameter is in the parameter window *Logic/Threshold* \ parameter window *Logic/Threshold x*.

7.4.108 Sending and switching delay after bus voltage recovery

This parameter is used to define the sending and switching delay after bus voltage recovery.

More information: → [Sending and switching delay, Page 291](#).

i Note

The device draws energy for switching the outputs via the bus (ABB i-bus® KNX). After application of the bus voltage and after bus voltage recovery, it takes about 10 ... 30 seconds before sufficient energy is available to switch all relays simultaneously.

The first relay is not switched until the device has stored sufficient energy to place all outputs in a defined contact position if there is a bus voltage failure.

i Note

After bus voltage recovery, the device waits for the sending delay time to elapse before sending telegrams on the bus.

Option

00:00:02 ... 00:04:15 hh:mm:ss

Prerequisites for visibility

- The parameter is in the parameter window [Device settings](#).

7.4.109 Sending cycle

This parameter is used to define the cycle in which the Group Object *In operation* sends a telegram.

Option

00:00:01 ... 00:10:00 ... 18:12:15 hh:mm:ss

Prerequisites for visibility

- Parameter window [Device settings](#) \ Parameter [Enable Group Object "In operation"](#) \ Options *Yes, send value 0 cyclically / Yes, send value 1 cyclically*
- The parameter is in the parameter window [Device settings](#).

7.4.110 Read safety Group Objects after bus voltage recovery and download

This parameter is used to define whether the following safety Group Objects are read after bus voltage recovery or download:

- [Safety priority x](#)
- [Wind alarm x](#)
- [Rain alarm](#)
- [Frost alarm](#)

i Note

To update the Group Objects after bus voltage recovery and download, the read flags must be set for the corresponding Group Objects of the sending device.

Option	
<u>No</u>	The safety Group Objects are not read after bus voltage recovery and download.
<u>Yes</u>	The safety Group Objects send a Value Read to the sending Group Objects after bus voltage recovery and download. If there are alarms present, the parameterized results are run. → Value Read, Page 292

Prerequisites for visibility

- The parameter is in the parameter window [Safety/Weather alarms](#).

7.4.111 Deactivate Automatic sun protection on cancellation of weather alarms, block and forced operation

This parameter is used to define whether the function *Automatic sun protection* is deactivated after the cancellation of weather alarms or the functions *Block* and *Forced operation*.

Option	
<u>No</u>	
<u>Yes</u>	

Prerequisites for visibility

- Parameter window [Configuration](#)
 - Parameter [Enable output X + Y](#) \ Option [Yes](#)
 - Parameter [Application](#) \ Option [Shutter Actuator](#)
- Parameter window [Shutter Actuator X+Y](#) \ Parameter window [Shutter Actuator functions](#)
 - Parameter [Enable function Safety/Weather alarms](#) \ Option [Yes](#)
 - Parameter [Enable function Automatic sun protection](#) \ Option [Yes](#)
- Parameter window [Shutter Actuator X+Y](#) \ Parameter window [Safety/Weather alarms](#) \ Parameter [Parameter setting](#) \ Option [Individual](#)
- The parameter is in the parameter window [Shutter Actuator X+Y](#) \ parameter window [Safety/Weather alarms](#).

7.4.112 Read Automatic sun protection Group Objects after bus voltage recovery and download

This parameter is used to define whether the values for the Automatic sun protection Group Objects are read and updated after bus voltage recovery or ETS download.

More information: → [Function Automatic sun protection, Page 100](#).

i Note

To read the Group Objects, the read flags must be set for the corresponding Group Objects of the sending device.

Option

No

Yes

Prerequisites for visibility

- Parameter window [Configuration](#)
 - Parameter [Enable output X + Y](#) \ Option *Yes*
 - Parameter [Application](#) \ Option *Shutter Actuator*
- Parameter window [Shutter Actuator X+Y](#) \ Parameter window [Shutter Actuator functions](#) \ Parameter [Enable function Automatic sun protection](#) \ Option *Yes*
- Parameter window [Shutter Actuator X+Y](#) \ Parameter window [Automatic sun protection](#) \ Parameter [Parameter setting](#) \ Option *Individual*
- The parameter is in the parameter window [Shutter Actuator X+Y](#) \ parameter window [Automatic sun protection](#).

7.4.113 Limit step commands to number of slat adjustments

This parameter is used to define whether the execution of Step commands is limited to the number of slat adjustments set in the parameter [Number of slat adjustments/steps \(from 0 % = open to 100 % = closed\)](#).

Option

No

Yes

Prerequisites for visibility

- Parameter window [Configuration](#) \ Parameter [Enable output X + Y](#) \ Option *Yes*
- Parameter window [Shutter Actuator X+Y](#) \ Parameter window [Shutter Actuator functions](#)
 - Parameter [Application](#) \ Option *Shutter Actuator*
 - Parameter [Operating mode](#) \ Option *Blind/Shutter control with slat adjustment*
- Parameter window [Shutter Actuator X+Y](#) \ Parameter window [Blind/Shutter](#) \ Parameter [Parameter setting](#) \ Option *Individual*
- The parameter is in the parameter window [Shutter Actuator X+Y](#) \ Parameter window [Blind/Shutter](#).

7.4.114 Tensioning/Slot positioning

This parameter is used to define whether to tension the Blind/Shutter or position the slots.

More information: → [Tensioning/Slot positioning, Page 289](#).

Option	
<u>No</u>	No Tensioning/Slot positioning is performed.
<u>After each down movement</u>	Tensioning/Slot positioning is performed after each down movement. The following dependent parameters are shown: <ul style="list-style-type: none"> • Duration for tensioning
<u>After reaching lower end position</u>	The tensioning/slow positioning is performed after reaching lower end position. The following dependent parameters are shown: <ul style="list-style-type: none"> • Duration for tensioning

Prerequisites for visibility

- Parameter window [Configuration](#)
 - Parameter [Enable output X + Y](#) \ Option *Yes*
 - Parameter [Application](#) \ Option *Shutter Actuator*
- Parameter window [Shutter Actuator X+Y](#) \ Parameter window [Shutter Actuator functions](#) \ Parameter [Operating mode](#) \ Option *Blind/Shutter control without slat adjustment*
- Parameter window [Shutter Actuator X+Y](#) \ Parameter window [Blind/Shutter](#) \ Parameter [Parameter setting](#) \ Option *Individual*
- The parameter is in the parameter window [Shutter Actuator X+Y](#) \ parameter window [Blind/Shutter](#).

7.4.115 Overwrite Scenes on download

This parameter is used to define whether the Scenes saved in the device are overwritten during a download.

Option	
<u>No</u>	
<u>Yes</u>	

Prerequisites for visibility

Configuration as Shutter Actuator

- Parameter window [Configuration](#)
 - Parameter [Enable output X + Y](#) \ Option *Yes*
 - Parameter [Application](#) \ Option *Shutter Actuator*
- Parameter window [Shutter Actuator X+Y](#) \ Parameter window [Shutter Actuator functions](#) \ Parameter [Enable function Scenes \[Shutter Actuator\]](#) \ Option *Yes*
- Parameter window [Shutter Actuator X+Y](#) \ Parameter window [Scene assignments \[Shutter Actuator\]](#) \ Parameter [Parameter setting](#) \ Option *Individual*
- The parameter is in the parameter window [Shutter Actuator X+Y](#) \ parameter window [Scene assignments \[Shutter Actuator\]](#).

or

Configuration as Switch Actuator

- Parameter window [Configuration](#)
 - Parameter [Enable output X + Y](#) \ Option *Yes*
 - Parameter [Application](#) \ Option *Switch Actuator*
- Parameter window [Switch Actuator X](#) \ Parameter window [Functions Switch Actuator](#) \ Parameter [Enable function Scenes \[Switch Actuator\]](#) \ Option *Yes*
- Parameter window [Switch Actuator X](#) \ Parameter window [Scene assignments \[Switch Actuator\]](#) \ Parameter [Parameter setting](#) \ Option *Individual*
- The parameter is in the parameter window [Switch Actuator X](#) \ parameter window [Scene assignments \[Switch Actuator\]](#).

7.4.116 Scene number

This parameter is used to define the Scene number (1 ... 64).

Option

1... 64

Prerequisites for visibility

Configuration as Shutter Actuator

- Parameter window [Configuration](#)
 - Parameter [Enable output X + Y](#) \ Option *Yes*
 - Parameter [Application](#) \ Option *Shutter Actuator*
- Parameter window [Shutter Actuator X+Y](#) \ Parameter window [Shutter Actuator functions](#) \ Parameter [Enable function Scenes \[Shutter Actuator\]](#) \ Option *Yes*
- Parameter window [Shutter Actuator X+Y](#) \ Parameter window [Scene assignments \[Shutter Actuator\]](#)
 - Parameter [Parameter setting](#) \ Option *Individual*
 - Parameter [Enable Scene assignment x \[Shutter Actuator\]](#) \ Option *Yes*
- The parameter is in the parameter window [Shutter Actuator X+Y](#) \ parameter window [Scene assignments \[Shutter Actuator\]](#).

or

Configuration as Switch Actuator

- Parameter window [Configuration](#)
 - Parameter [Enable output X + Y](#) \ Option *Yes*
 - Parameter [Application](#) \ Option *Switch Actuator*
- Parameter window [Switch Actuator X](#) \ Parameter window [Functions Switch Actuator](#) \ Parameter [Enable function Scenes \[Switch Actuator\]](#) \ Option *Yes*
- Parameter window [Switch Actuator X](#) \ Parameter window [Scene assignments \[Switch Actuator\]](#)
 - Parameter [Parameter setting](#) \ Option *Individual*
 - Parameter [Enable Scene assignment x \[Switch Actuator\]](#) \ Option *Yes*
- The parameter is in the parameter window [Switch Actuator X](#) \ parameter window [Scene assignments \[Switch Actuator\]](#).

7.4.117 Scene assignment

This parameter is used to define which Scene assignment is recalled.

Note

The Scene assignment must be parameterized before use.

Option

1... 16

Prerequisites for visibility

- The parameter appears at various points in the application. The visibility is dependent on the application and the higher-level parameter.

7.4.118 Enable Scene assignment x [Shutter Actuator]

This parameter is used to create and enable the Scene assignment x (x = 1 ... 16) and assign the output.

Option	
No	Scene assignment x is not used.
Yes	The following dependent parameters are shown: <ul style="list-style-type: none"> • Recall Scene x also via 1-bit Group Object • Scene number • Delay • Position height (0 % = top; 100 % = bottom) • Position slat (0 % = open; 100 % = closed)

Prerequisites for visibility

- Parameter window [Configuration](#)
 - Parameter [Enable output X + Y](#) \ Option Yes
 - Parameter [Application](#) \ Option [Shutter Actuator](#)
- Parameter window [Shutter Actuator X+Y](#) \ Parameter window [Shutter Actuator functions](#) \ Parameter [Enable function Scenes \[Shutter Actuator\]](#) \ Option Yes
- Parameter window [Shutter Actuator X+Y](#) \ Parameter window [Scene assignments \[Shutter Actuator\]](#) \ Parameter [Parameter setting](#) \ Option [Individual](#)
- The parameter is in the parameter window [Shutter Actuator X+Y](#) \ parameter window [Scene assignments \[Shutter Actuator\]](#).

7.4.119 Enable Scene assignment x [Switch Actuator]

This parameter is used to create and enable the Scene assignment x (x = 1 ... 16) and assign the output.

Option	
No	Scene assignment x is not used.
Yes	The following dependent parameters are shown: <ul style="list-style-type: none"> • Recall Scene x also via 1-bit Group Object • Scene number • Delay • Reaction on Scene recall

Prerequisites for visibility

- Parameter window [Configuration](#)
 - Parameter [Enable output X + Y](#) \ Option Yes
 - Parameter [Application](#) \ Option [Switch Actuator](#)
- Parameter window [Switch Actuator X](#) \ Parameter window [Functions Switch Actuator](#) \ Parameter [Enable function Scenes \[Switch Actuator\]](#) \ Option Yes
- Parameter window [Switch Actuator X](#) \ Parameter window [Scene assignments \[Switch Actuator\]](#) \ Parameter [Parameter setting](#) \ Option [Individual](#)
- The parameter is in the parameter window [Switch Actuator X](#) \ parameter window [Scene assignments \[Switch Actuator\]](#).

7.4.120 GATE blocks if Group Object "Connection A" equals

This parameter is used to define the telegram value on the Group Object *Connection A* for which the GATE is blocked. If the GATE is blocked, telegrams received on the Group Object *Connection B* are ignored.

Option

1

0

Prerequisites for visibility

- Parameter window *Configuration* \ Parameter *Enable Logic/Threshold x-y* \ Option *Yes*
- Parameter window *Logic/Threshold* \ Parameter window *Logic/Threshold x* \ Parameter *Function of the logic gate* \ Option *GATE*
- The parameter is in the parameter window *Logic/Threshold* \ parameter window *Logic/Threshold x*.

7.4.121 Dead time Blind/Shutter movement from lower end position (100 %)

This parameter is used to set the dead time compensation for Blind/Shutter opening. The "Blind/Shutter opening" dead time describes the time between the reception of the up command and the start of Blind/Shutter opening.

More information: → [Dead times, Page 288](#).

Example

1. The Blind/Shutter is in the lower end position (= 100 %).
2. The telegram value 50 % is received.
 - ⇒ The motor shaft starts turning. The Blind/Shutter remains unchanged in the lower end position.
3. The visible upward movement of the Blind/Shutter starts after the dead time has elapsed.
 - ⇒ The Blind/Shutter does not reach the required position 50 %.
 - ⇒ Due to the compensation set, the motor shaft turns for longer and the Blind/Shutter moves to the required position 50 %.

Option

0... 5,000 ms

Prerequisites for visibility

- Parameter window *Configuration*
 - Parameter *Enable output X + Y* \ Option *Yes*
 - Parameter *Application* \ Option *Shutter Actuator*
- Parameter window *Shutter Actuator X+Y* \ Parameter window *Blind/Shutter*
 - Parameter *Parameter setting* \ Option *Individual*
 - Parameter *Set dead times* \ Option *User-defined*
- The parameter is in the parameter window *Shutter Actuator X+Y* \ parameter window *Blind/Shutter*.

7.4.122 Dead time Blind/Shutter adjustment on change of direction

This parameter is used to set the dead time compensation for blind/slat adjustment after a direction change. The "Blind/slat adjustment" dead time describes the time between the reception of a direction changing movement command and the execution of the movement command.

More information: → [Dead times, Page 288](#).

Example

1. The Blind/Shutter is open (= 50 %).
 2. The "Blind/Shutter down" telegram is received.
 - ⇒ The Blind/Shutter closes to 60 %.
 3. The "Blind/Shutter up" telegram is received (direction change).
 - ⇒ The Blind/Shutter opens to 55 %.
- ⇒ Due to the compensation set, the motor shaft turns for longer and the Blind/Shutter moves to the required position (= 50 %).

Option

0... 5,000 ms

Prerequisites for visibility

- Parameter window [Configuration](#)
 - Parameter [Enable output X + Y](#) \ Option *Yes*
 - Parameter [Application](#) \ Option *Shutter Actuator*
- Parameter window [Shutter Actuator X+Y](#) \ Parameter window [Shutter Actuator functions](#) \ Parameter [Operating mode](#) \ Option *Blind/Shutter control without slat adjustment*
- Parameter window [Shutter Actuator X+Y](#) \ Parameter window [Blind/Shutter](#)
 - Parameter [Parameter setting](#) \ Option *Individual*
 - Parameter [Set dead times](#) \ Option *User-defined*
- The parameter is in the parameter window [Shutter Actuator X+Y](#) \ parameter window [Blind/Shutter](#).

7.4.123**Dead time slat movement (from 100 % closed)**

This parameter is used to set the dead time compensation for slat opening from the closed position (= 100 %). The "Slat opening" dead time describes the time between the reception of the open command and the start of slat opening.

More information: → [Dead times, Page 288](#).

Example

The slats are fully closed (= 100 %). The Slat adjustment Up telegram is received. The motor shaft starts turning. However, the slats stay closed and adjustment begins only after the dead time expires.

1. The slats are closed (= 100 %).
 2. The "Open slat" telegram is received.
 - ⇒ The motor shaft starts turning. The slats remain closed and unchanged.
 3. The visible slat opening starts after the dead time has elapsed.
 - ⇒ The slat does not reach the required position.
- ⇒ Due to the compensation set, the motor shaft turns for longer and the slat moves to the required position.

Option

0... 5,000 ms

Prerequisites for visibility

- Parameter window [Configuration](#)
 - Parameter [Enable output X + Y](#) \ Option *Yes*
 - Parameter [Application](#) \ Option *Shutter Actuator*
- Parameter window [Shutter Actuator X+Y](#) \ Parameter window [Shutter Actuator functions](#) \ Parameter [Operating mode](#) \ Option *Blind/Shutter control with slat adjustment*
- Parameter window [Shutter Actuator X+Y](#) \ Parameter window [Blind/Shutter](#)
 - Parameter [Parameter setting](#) \ Option *Individual*
 - Parameter [Set dead times](#) \ Option *User-defined*
- The parameter is in the parameter window [Shutter Actuator X+Y](#) \ parameter window [Blind/Shutter](#).

7.4.124 Dead time slat adjustment on change of direction

This parameter is used to set the dead time compensation for slat adjustment after a direction change. The "Slat adjustment" dead time describes the time between the reception of a direction changing movement command and the execution of the movement command.

More information: → [Dead times, Page 288](#).

Example

1. The slats are in the 50 % position.
2. The 60 % telegram is received.
 - ⇒ The slats close.
3. The slats are in the 60 % position.
4. The 50 % telegram is received (direction change).
 - ⇒ The slats open.
5. The slats are in the 55 % position.
 - ⇒ Due to the compensation set, the motor shaft turns for longer and the slats move to the required position (= 50 %).

Option

0... 5,000 ms

Prerequisites for visibility

- Parameter window [Configuration](#)
 - Parameter [Enable output X + Y](#) \ Option *Yes*
 - Parameter [Application](#) \ Option *Shutter Actuator*
- Parameter window [Shutter Actuator X+Y](#) \ Parameter window [Shutter Actuator functions](#) \ Parameter [Operating mode](#) \ Option *Blind/Shutter control with slat adjustment*
- Parameter window [Shutter Actuator X+Y](#) \ Parameter window [Blind/Shutter](#)
 - Parameter [Parameter setting](#) \ Option *Individual*
 - Parameter [Set dead times](#) \ Option *User-defined*
- The parameter is in the parameter window [Shutter Actuator X+Y](#) \ parameter window [Blind/Shutter](#).

7.4.125 Set dead times

This parameter is used to define whether the default dead times or user-defined dead times are used for the activation of the drive connected.

More information: → [Dead times, Page 288](#).

**CAUTION – Malfunctions**

Incorrect settings in the parameters can cause malfunctions.

- ▶ Observe the technical data of the connected drive.

OptionDefault

The following values are used:

- Blind/Shutter dead time: 0 ms
- Slat dead time: 0 ms
- Slippage of Blind/Shutter on change of direction: 0 ms

User-defined

The values can be set individually.

The following dependent parameters are shown:

- [Dead time Blind/Shutter movement from lower end position \(100 %\)](#)
- [Dead time slat movement \(from 100 % closed\)](#)
- [Dead time Blind/Shutter adjustment on change of direction](#)
- [Dead time slat adjustment on change of direction](#)

Prerequisites for visibility

- Parameter window [Configuration](#)
 - Parameter [Enable output X + Y](#) \ Option *Yes*
 - Parameter [Application](#) \ Option *Shutter Actuator*
- Parameter window [Shutter Actuator X+Y](#) \ Parameter window [Blind/Shutter](#) \ Parameter [Parameter setting](#) \ Option *Individual*
- The parameter is in the parameter window [Shutter Actuator X+Y](#) \ parameter window [Blind/Shutter](#).

7.4.126**Block staircase lighting after bus voltage recovery**

This parameter is used to define whether the function *Staircase lighting* is blocked after bus voltage recovery.

OptionNoYes**Prerequisites for visibility**

- Parameter window [Configuration](#)
 - Parameter [Enable output X + Y](#) \ Option *Yes*
 - Parameter [Application](#) \ Option *Switch Actuator*
- Parameter window [Switch Actuator X](#) \ Parameter window [Functions Switch Actuator](#) \ Parameter [Enable function Time](#) \ Option *Staircase lighting*
- Parameter window [Switch Actuator X](#) \ Parameter window [Staircase lighting](#)
 - Parameter [Parameter setting](#) \ Option *Individual*
 - Parameter [Block staircase lighting via Group Object](#) \ Option *Yes*
- The parameter is in the parameter window [Switch Actuator X](#) \ parameter window [Staircase lighting](#).

7.4.127 Switching reaction of staircase lighting on telegram value 0/1

This parameter is used to define the telegram value with which the output is switched on and prematurely switched off.

i Note

If the function *Permanent on* is active, the function *Staircase lighting* cannot be switched off prematurely

Option

<i>On with "1" and off with "0"</i>	The output is switched on with the telegram value 1 and off with the telegram value 0.
<i>On with "1" and no action for "0"</i>	The output is switched on with the telegram value 1. Premature switch-off is not possible.
<i>On with "1" or with "0", no switch off</i>	The output is switched on independently of the telegram value. Premature switch-off is not possible.

Prerequisites for visibility

- Parameter window [Configuration](#)
 - Parameter [Enable output X + Y](#) \ Option *Yes*
 - Parameter [Application](#) \ Option *Switch Actuator*
- Parameter window [Switch Actuator X](#) \ Parameter window [Functions Switch Actuator](#) \ Parameter [Enable function Time](#) \ Option *Staircase lighting*
- Parameter window [Switch Actuator X](#) \ Parameter window [Staircase lighting](#) \ Parameter [Parameter setting](#) \ Option *Individual*
- The parameter is in the parameter window [Switch Actuator X](#) \ parameter window [Staircase lighting](#).

7.4.128 Block staircase lighting via Group Object

This parameter is used to define whether the function *Staircase lighting* can be blocked via Group Object. If the function *Staircase lighting* is blocked, the switch-on command is forwarded without time function in the function chain. The output reacts according to its parameterization.

Option

<i>No</i>	The function <i>Staircase lighting</i> cannot be blocked via a Group Object.
<i>Yes</i>	The following dependent parameters are shown: <ul style="list-style-type: none"> Block staircase lighting after bus voltage recovery The following dependent Group Objects are displayed: <ul style="list-style-type: none"> Block staircase lighting

Prerequisites for visibility

- Parameter window [Configuration](#)
 - Parameter [Enable output X + Y](#) \ Option *Yes*
 - Parameter [Application](#) \ Option *Switch Actuator*
- Parameter window [Switch Actuator X](#) \ Parameter window [Functions Switch Actuator](#) \ Parameter [Enable function Time](#) \ Option *Staircase lighting*
- Parameter window [Switch Actuator X](#) \ Parameter window [Staircase lighting](#) \ Parameter [Parameter setting](#) \ Option *Individual*
- The parameter is in the parameter window [Switch Actuator X](#) \ parameter window [Staircase lighting](#).

7.4.129 Staircase lighting time

This parameter is used to define how long the output remains switched on after an On telegram.

Option
00:00:00 ... 00:05:00 ... 18:12:15 hh:mm:ss

Prerequisites for visibility

- Parameter window [Configuration](#)
 - Parameter [Enable output X + Y](#) \ Option *Yes*
 - Parameter [Application](#) \ Option *Switch Actuator*
- Parameter window [Switch Actuator X](#) \ Parameter window [Functions Switch Actuator](#) \ Parameter [Enable function Time](#) \ Option *Staircase lighting*
- Parameter window [Switch Actuator X](#) \ Parameter window [Staircase lighting](#) \ Parameter [Parameter setting](#) \ Option *Individual*
- The parameter is in the parameter window [Switch Actuator X](#) \ parameter window [Staircase lighting](#).

7.4.130 Overwrite staircase lighting time on download

This parameter is used to define whether the staircase lighting time is overwritten while downloading the application to the device.

Option	
<i>No</i>	The existing values in the device are not overwritten.
<i>Yes</i>	The existing values in the device are overwritten with the values defined in ETS.

Prerequisites for visibility

- Parameter window [Configuration](#)
 - Parameter [Enable output X + Y](#) \ Option *Yes*
 - Parameter [Application](#) \ Option *Switch Actuator*
- Parameter window [Switch Actuator X](#) \ Parameter window [Functions Switch Actuator](#) \ Parameter [Enable function Time](#) \ Option *Staircase lighting*
- Parameter window [Switch Actuator X](#) \ Parameter window [Staircase lighting](#)
 - Parameter [Parameter setting](#) \ Option *Individual*
 - Parameter [Change staircase lighting time via Group Object](#) \ Option *Yes*
 - or
 - Parameter [Change staircase lighting time via i-bus® Tool](#) \ Option *Yes*
- The parameter is in the parameter window [Switch Actuator X](#) \ parameter window [Staircase lighting](#).

7.4.131 Restart staircase lighting time after permanent on

This parameter is used to define how the staircase lighting time reacts after the function *Permanent on* is restarted.

Option	
<i>No</i>	The output is switched off after the function <i>Permanent on</i> is ended.
<i>Yes</i>	The staircase lighting time is restarted and the output remains switched on after the function <i>Permanent on</i> is ended.

Prerequisites for visibility

- Parameter window [Configuration](#)
 - Parameter [Enable output X + Y](#) \ Option *Yes*
 - Parameter [Application](#) \ Option *Switch Actuator*
- Parameter window [Switch Actuator X](#) \ Parameter window [Functions Switch Actuator](#) \ Parameter [Enable function Time](#) \ Option *Staircase lighting*
- Parameter window [Switch Actuator X](#) \ Parameter window [Staircase lighting](#) \ Parameter [Parameter setting](#) \ Option *Individual*
- The parameter is in the parameter window [Switch Actuator X](#) \ parameter window [Staircase lighting](#).

7.4.132 Staircase lighting time can be started again

This parameter is used to define whether the staircase lighting time is extended by further On telegrams.

Option	
<i>No</i>	Further On telegrams will be ignored. The staircase lighting time will not be extended.
<i>Yes</i>	The staircase lighting time will be extended by additional On telegrams. The number of extensions can be set in the parameter Staircase lighting time extendable (pumping) . More information: → Function Staircase lighting, Page 104 . The following dependent parameters are shown: <ul style="list-style-type: none"> • Staircase lighting time extendable (pumping)

Prerequisites for visibility

- Parameter window [Configuration](#)
 - Parameter [Enable output X + Y](#) \ Option *Yes*
 - Parameter [Application](#) \ Option *Switch Actuator*
- Parameter window [Switch Actuator X](#) \ Parameter window [Functions Switch Actuator](#) \ Parameter [Enable function Time](#) \ Option *Staircase lighting*
- Parameter window [Switch Actuator X](#) \ Parameter window [Staircase lighting](#) \ Parameter [Parameter setting](#) \ Option *Individual*
- The parameter is in the parameter window [Switch Actuator X](#) \ parameter window [Staircase lighting](#).

7.4.133 Change staircase lighting time via i-bus® Tool

This parameter is used to define whether the staircase lighting time set in ETS can be changed via i-bus® Tool.

Note

The interface to i-bus® Tool is available from the following software versions:

- Application from V1.2
- Firmware from V0.2.0

Option

<i>No</i>	The staircase lighting time can be defined only in ETS.
<i>Yes</i>	The following dependent parameters are shown: <ul style="list-style-type: none"> • Overwrite staircase lighting time on download

Prerequisites for visibility

- Parameter window [Configuration](#)
 - Parameter [Enable output X + Y](#) \ Option *Yes*
 - Parameter [Application](#) \ Option *Switch Actuator*
- Parameter window [Switch Actuator X](#) \ Parameter window [Functions Switch Actuator](#) \ Parameter [Enable function Time](#) \ Option *Staircase lighting*
- Parameter window [Switch Actuator X](#) \ Parameter window [Staircase lighting](#) \ Parameter [Parameter setting](#) \ Option *Individual*
- The parameter is in the parameter window [Switch Actuator X](#) \ parameter window [Staircase lighting](#).

7.4.134 Change staircase lighting time via Group Object

This parameter is used to define whether the staircase lighting time set in ETS can be changed via the Group Object [Staircase lighting time](#).

Note

The changed staircase lighting time is used only the next time the function [Staircase lighting](#) is retrieved.

Option

<i>No</i>	The staircase lighting time can be defined only in ETS.
<i>Yes</i>	The following dependent parameters are shown: <ul style="list-style-type: none"> • Overwrite staircase lighting time on download The following dependent Group Objects are displayed: <ul style="list-style-type: none"> • Staircase lighting time

Prerequisites for visibility

- Parameter window [Configuration](#)
 - Parameter [Enable output X + Y](#) \ Option *Yes*
 - Parameter [Application](#) \ Option *Switch Actuator*
- Parameter window [Switch Actuator X](#) \ Parameter window [Functions Switch Actuator](#) \ Parameter [Enable function Time](#) \ Option *Staircase lighting*
- Parameter window [Switch Actuator X](#) \ Parameter window [Staircase lighting](#) \ Parameter [Parameter setting](#) \ Option *Individual*
- The parameter is in the parameter window [Switch Actuator X](#) \ parameter window [Staircase lighting](#).

7.4.135 Staircase lighting time extendable (pumping)

This parameter is used to define how often the staircase lighting time can be extended.

Option	
<i>No, can only be started again</i>	The staircase lighting time can be restarted any number of times by further On telegrams.
<i>Up to max. 2x staircase lighting time</i>	The staircase lighting time can be extended up to twice the duration. Extension occurs when further On telegrams are received after switching on.
<i>Up to max. 3x staircase lighting time</i>	The staircase lighting time can be extended up to three times the duration. Extension occurs when further On telegrams are received after switching on.
<i>Up to max. 4x staircase lighting time</i>	The staircase lighting time can be extended up to four times the duration. Extension occurs when further On telegrams are received after switching on.
<i>Up to max. 5x staircase lighting time</i>	The staircase lighting time can be extended up to five times the duration. Extension occurs when further On telegrams are received after switching on.

Prerequisites for visibility

- Parameter window [Configuration](#) \
 - Parameter [Enable output X + Y](#) \ Option *Yes*
 - Parameter [Application](#) \ Option *Switch Actuator*
- Parameter window [Switch Actuator X](#) \ Parameter window [Functions Switch Actuator](#) \ Parameter [Enable function Time](#) \ Option *Staircase lighting*
- Parameter window [Switch Actuator X](#) \ Parameter window [Staircase lighting](#)
 - Parameter [Parameter setting](#) \ Option *Individual*
 - Parameter [Staircase lighting time can be started again](#) \ Option *Yes*
- The parameter is in the parameter window [Switch Actuator X](#) \ parameter window [Staircase lighting](#).

7.4.136

Reversing time



CAUTION

Setting a reversing time that is too short can damage the connected drive.

- ▶ Observe the technical data of the connected drive.

This parameter is used to define the duration of the reversing time.

i Note

The reversing time is the required pause while the Blind/Shutter changes direction. The device must be deenergized during this period.

i Note

If bus voltage failure occurs, a reversing time of 1 second is always used. In operation with the bus voltage present, the parameterized value applies.

Option	
<i>50 ... 500 ... 5000 ms</i>	

Prerequisites for visibility

- Parameter window [Configuration](#)
 - Parameter [Enable output X + Y](#) \ Option *Yes*
 - Parameter [Application](#) \ Option *Shutter Actuator*
- Parameter window [Shutter Actuator X+Y](#) \ Parameter window [Drive](#) \ Parameter [Parameter setting](#) \ Option *Individual*
- The parameter is in the parameter window [Shutter Actuator X+Y](#) \ parameter window [Drive](#).

7.4.137 Lower limit (0 % = top; 100 % = bottom)

This parameter is used to define the lower limit for the travel range limit.

More information: → [Travel range limit, Page 288](#).

Option

0 ... 100 %

Prerequisites for visibility

- Parameter window [Configuration](#) \
 - Parameter [Enable output X + Y](#) \ Option *Yes*
 - Parameter [Application](#) \ Option *Shutter Actuator*
- Parameter window [Shutter Actuator X+Y](#) \ Parameter window [Blind/Shutter](#)
 - Parameter [Parameter setting](#) \ Option *Individual*
 - Parameter [Limit travel range via Group Object](#) \ Options *Move Blind/Shutter Up/Down limited / Activate limitation*
- The parameter is in the parameter window [Shutter Actuator X+Y](#) \ parameter window [Blind/Shutter](#).

7.4.138 Lower limit valid for direct commands

This parameter is used to define whether the upper travel range limit applies to direct commands.

More information → [Direct operation, Page 102](#), → [Travel range limit, Page 288](#).

Option

No

Yes

Prerequisites for visibility

- Parameter window [Configuration](#) \
 - Parameter [Enable output X + Y](#) \ Option *Yes*
 - Parameter [Application](#) \ Option *Shutter Actuator*
- Parameter window [Shutter Actuator X+Y](#) \ Parameter window [Blind/Shutter](#)
 - Parameter [Parameter setting](#) \ Option *Individual*
 - Parameter [Limit travel range via Group Object](#) \ Option *Activate limitation*
- The parameter is in the parameter window [Shutter Actuator X+Y](#) \ parameter window [Blind/Shutter](#).

7.4.139 Lower limit valid for Automatic sun protection commands

This parameter is used to define whether the lower travel range limit applies to Automatic sun protection commands.

More information → [Function Automatic sun protection, Page 100](#), → [Travel range limit, Page 288](#).

Option

No

Yes

Prerequisites for visibility

- Parameter window [Configuration](#) \
 - Parameter [Enable output X + Y](#) \ Option *Yes*
 - Parameter [Application](#) \ Option *Shutter Actuator*
- Parameter window [Shutter Actuator X+Y](#) \ Parameter window [Blind/Shutter](#)
 - Parameter [Parameter setting](#) \ Option *Individual*
 - Parameter [Limit travel range via Group Object](#) \ Option *Activate limitation*
- The parameter is in the parameter window [Shutter Actuator X+Y](#) \ parameter window [Blind/Shutter](#).

7.4.140 Lower threshold

This parameter is used to define the lower threshold. Default values and units depend on the option selected in the *Data point type of Group Object "Threshold input"* parameter.

Option	
0 ... 20 ... 100 %	Lower threshold on selection of DPT 5.001.
0 ... 100 ... 255	Lower threshold on selection of DPT 5.010.
0 ... 10,000 ... 65535	Lower threshold on selection of DPT 7.001.
-100 ... 18 ... 250 °C	Lower threshold on selection of DPT 9.001.
0 ... 100 ... 100,000 lux	Lower threshold on selection of DPT 9.004.
0 ... 1000 ... 240000 mA	Lower threshold on selection of DPT 9.021.
0 ... 1 ... 24 A	Lower threshold on selection of DPT 14.019.
0 ... 40 ... 10000 W	Lower threshold on selection of DPT 14.056.
0 ... 1 ... 10 kW	Lower threshold on selection of DPT 9.024.
0 ... 1000 ... 2147483647 Wh	Lower threshold on selection of DPT 13.010.
0 ... 25 ... 2147483647 kWh	Lower threshold on selection of DPT 13.013.

Prerequisites for visibility

- Parameter window *Configuration* \ Parameter *Enable Logic/Threshold x-y* \ Option *Yes*
- Parameter window *Logic/Threshold* \ Parameter window *Logic/Threshold x* \ Parameter *Function of the logic gate* \ Option *Threshold*
- The parameter is in the parameter window *Logic/Threshold* \ parameter window *Logic/Threshold x*.

7.4.141 Reaction on result "0" [Shutter Actuator]

This parameter is used to define the Blind/Shutter reaction if the result of the Logic or Threshold function is 0.

The result does not inevitably lead to movement of the Blind/Shutter.

i Note

Whether a movement takes place is dependent on the following factors:

- Parameterization of the output → [Function diagram Shutter Actuator, Page 86](#)
- Priorities → [Priorities, Page 281](#)

Option	
<i>No reaction</i>	If the Blind/Shutter is moving, it will continue until reaching the target position. If the Blind/Shutter is at rest, its position will remain unchanged.
<i>Up</i>	Acts like an Up telegram on the Group Object <i>Move Blind/Shutter Up/Down</i> .
<i>Down</i>	Acts like a Down telegram on the Group Object <i>Move Blind/Shutter Up/Down</i> .
<i>Stop</i>	Acts like a Stop telegram on one of the following Group Objects: <ul style="list-style-type: none"> • <i>Stop Up/Down</i> • <i>Slat adjustment / Stop Up/Down</i>
<i>Scene assignment</i>	The reaction specified in Scene assignment x is performed. The following dependent parameters are shown: <ul style="list-style-type: none"> • <i>Scene assignment</i>
<i>Individual position</i>	The required positions of the Blind/Shutter and slats (depending on operating mode) can be defined in separate parameters. The following dependent parameters are shown: <ul style="list-style-type: none"> • <i>Position height (0 % = top; 100 % = bottom)</i> • <i>Position slat (0 % = open; 100 % = closed)</i>

Prerequisites for visibility

- Parameter window *Configuration*
 - Parameter *Enable output X + Y* \ Option *Yes*
 - Parameter *Application* \ Option *Shutter Actuator*
- Parameter window *Shutter Actuator X+Y* \ Parameter window *Shutter Actuator functions* \ Parameter *Output reacts to* \ Option *Logic/Threshold x*
- The parameter is in the parameter window *Shutter Actuator X+Y* \ parameter window *Shutter Actuator functions*.

7.4.142

Reaction on result "0" [Switch Actuator]

This parameter is used to define the reaction of the output if the result of the Logic or Threshold function is 0.

The result does not necessarily lead to the position of the relay contact changing.

Note

Whether the relay contact is opened or closed depends on the following factors:

- Parameterization of the output → [Function diagram Switch Actuator, Page 87](#)
- Priorities → [Priorities, Page 281](#)
- Setting in the parameter *Reaction of output*

Option	
<i>No reaction</i>	The position of the relay contact remains unchanged.
<i>On</i>	This acts like an On telegram on the Group Object <i>Switch</i> .
<i>Off</i>	This acts like an Off telegram on the Group Object <i>Switch</i> .

Prerequisites for visibility

- Parameter window *Configuration*
 - Parameter *Enable output X + Y* \ Option *Yes*
 - Parameter *Application* \ Option *Switch Actuator*
- Parameter window *Switch Actuator X* \ Parameter window *Functions Switch Actuator* \ Parameter *Output reacts to* \ Option *Logic/Threshold x*
- The parameter is in the parameter window *Switch Actuator X* \ parameter window *Functions Switch Actuator*.

7.4.143 Reaction on result "1" [Shutter Actuator]

This parameter is used to define the Blind/Shutter reaction if the result of the Logic or Threshold function is 1.

The result does not inevitably lead to movement of the Blind/Shutter.

i Note

Whether a movement takes place is dependent on the following factors:

- Parameterization of the output → [Function diagram Shutter Actuator, Page 86](#)
- Priorities → [Priorities, Page 281](#)

Option	
<i>No reaction</i>	If the Blind/Shutter is moving, it will continue until reaching the target position. If the Blind/Shutter is at rest, its position will remain unchanged.
<i>Up</i>	Acts like an Up telegram on the Group Object Move Blind/Shutter Up/Down .
<i>Down</i>	Acts like a Down telegram on the Group Object Move Blind/Shutter Up/Down .
<i>Stop</i>	Acts like a Stop telegram on one of the following Group Objects: <ul style="list-style-type: none"> • Stop Up/Down • Slat adjustment / Stop Up/Down
<i>Scene assignment</i>	The reaction specified in Scene assignment x is performed. The following dependent parameters are shown: <ul style="list-style-type: none"> • Scene assignment
<i>Individual position</i>	The required positions of the Blind/Shutter and slats (depending on operating mode) can be defined in separate parameters. The following dependent parameters are shown: <ul style="list-style-type: none"> • Position height (0 % = top; 100 % = bottom) • Position slat (0 % = open; 100 % = closed)

Prerequisites for visibility

- Parameter window [Configuration](#)
 - Parameter [Enable output X + Y](#) \ Option *Yes*
 - Parameter [Application](#) \ Option *Shutter Actuator*
- Parameter window [Shutter Actuator X+Y](#) \ Parameter window [Shutter Actuator functions](#) \ Parameter [Output reacts to](#) \ Option *Logic/Threshold x*
- The parameter is in the parameter window [Shutter Actuator X+Y](#) \ parameter window [Shutter Actuator functions](#).

7.4.144 Reaction on result "1" [Switch Actuator]

This parameter is used to define the reaction of the output if the result of the Logic or Threshold function is 1.

The result does not necessarily lead to the position of the relay contact changing.

Note

Whether the relay contact is opened or closed depends on the following factors:

- Parameterization of the output → [Function diagram Switch Actuator, Page 87](#)
- Priorities → [Priorities, Page 281](#)
- Setting in the parameter [Reaction of output](#)

Option

<i>No reaction</i>	The position of the relay contact remains unchanged.
<i>On</i>	This acts like an On telegram on the Group Object Switch .
<i>Off</i>	This acts like an Off telegram on the Group Object Switch .

Prerequisites for visibility

- Parameter window [Configuration](#)
 - Parameter [Enable output X + Y](#) \ Option Yes
 - Parameter [Application](#) \ Option [Switch Actuator](#)
- Parameter window [Switch Actuator X](#) \ Parameter window [Functions Switch Actuator](#) \ Parameter [Output reacts to](#) \ Option [Logic/Threshold x](#)
- The parameter is in the parameter window [Switch Actuator X](#) \ parameter window [Functions Switch Actuator](#).

7.4.145 Reaction on sun = 0 (no sun)

This parameter is used to define how the Blind/Shutter reacts if the sun is no longer shining if the function [Automatic sun protection](#) is activated.

The change in the sunshine does not inevitably lead to movement of the Blind/Shutter.

Note

Whether a movement takes place is dependent on the following factors:

- Parameterization of the output → [Function diagram Shutter Actuator, Page 86](#)
- Priorities → [Priorities, Page 281](#)

Option	
<i>No reaction</i>	If the Blind/Shutter is moving, it will continue until reaching the target position. If the Blind/Shutter is at rest, its position will remain unchanged.
<i>Up</i>	Acts like an Up telegram on the Group Object Move Blind/Shutter Up/Down .
<i>Down</i>	Acts like a Down telegram on the Group Object Move Blind/Shutter Up/Down .
<i>Stop</i>	Acts like a Stop telegram on one of the following Group Objects: <ul style="list-style-type: none"> • Stop Up/Down • Slat adjustment / Stop Up/Down
<i>Scene assignment</i>	The reaction specified in Scene assignment x is performed. The following dependent parameters are shown: <ul style="list-style-type: none"> • Scene assignment
<i>Individual position</i>	The required positions of the Blind/Shutter and slats (depending on operating mode) can be defined in separate parameters. The following dependent parameters are shown: <ul style="list-style-type: none"> • Position height (0 % = top; 100 % = bottom) • Position slat (0 % = open; 100 % = closed)
<i>Receive height and slat via Group Objects</i>	The required Blind/Shutter and slat positions are received via the Group Objects Sun: Move to height and Sun: Move slat . The following dependent Group Objects are displayed: <ul style="list-style-type: none"> • Sun: Move to height • Sun: Move slat
<i>Receive only slat via Group Object</i>	The required slat position is received via the Group Object Sun: Move slat . The following dependent Group Objects are displayed: <ul style="list-style-type: none"> • Sun: Move slat

Prerequisites for visibility

- Parameter window [Configuration](#)
 - Parameter [Enable output X + Y](#) \ Option Yes
 - Parameter [Application](#) \ Option [Shutter Actuator](#)
- Parameter window [Shutter Actuator X+Y](#) \ Parameter window [Shutter Actuator functions](#) \ Parameter [Enable function Automatic sun protection](#) \ Option Yes
- Parameter window [Shutter Actuator X+Y](#) \ Parameter window [Automatic sun protection](#) \ Parameter [Parameter setting](#) \ Option [Individual](#)
- The parameter is in the parameter window [Shutter Actuator X+Y](#) \ parameter window [Automatic sun protection](#).

7.4.146

Reaction on sun = 1 (sun)

This parameter is used to define how the Blind/Shutter reacts in sunshine if the function *Automatic sun protection* is activated.

The change in the sunshine does not inevitably lead to movement of the Blind/Shutter.

Note

Whether a movement takes place is dependent on the following factors:

- Parameterization of the output → [Function diagram Shutter Actuator, Page 86](#)
- Priorities → [Priorities, Page 281](#)

Option	
<i>No reaction</i>	If the Blind/Shutter is moving, it will continue until reaching the target position. If the Blind/Shutter is at rest, its position will remain unchanged.
<i>Up</i>	Acts like an Up telegram on the Group Object Move Blind/Shutter Up/Down .
<i>Down</i>	Acts like a Down telegram on the Group Object Move Blind/Shutter Up/Down .
<i>Stop</i>	Acts like a Stop telegram on one of the following Group Objects: <ul style="list-style-type: none"> • Stop Up/Down • Slat adjustment / Stop Up/Down
<i>Scene assignment</i>	The reaction specified in Scene assignment x is performed. The following dependent parameters are shown: <ul style="list-style-type: none"> • Scene assignment
<i>Individual position</i>	The required positions of the Blind/Shutter and slats (depending on operating mode) can be defined in separate parameters. The following dependent parameters are shown: <ul style="list-style-type: none"> • Position height (0 % = top; 100 % = bottom) • Position slat (0 % = open; 100 % = closed)
<i>Receive height and slat via Group Objects</i>	The required Blind/Shutter and slat positions are received via the Group Objects Sun: Move to height and Sun: Move slat . The following dependent Group Objects are displayed: <ul style="list-style-type: none"> • Sun: Move to height • Sun: Move slat
<i>Receive only slat via Group Object</i>	The required slat position is received via the Group Object Sun: Move slat . The following dependent Group Objects are displayed: <ul style="list-style-type: none"> • Sun: Move slat

Prerequisites for visibility

- Parameter window [Configuration](#)
 - Parameter [Enable output X + Y](#) \ Option [Yes](#)
 - Parameter [Application](#) \ Option [Shutter Actuator](#)
- Parameter window [Shutter Actuator X+Y](#) \ Parameter window [Shutter Actuator functions](#) \ Parameter [Enable function Automatic sun protection](#) \ Option [Yes](#)
- Parameter window [Shutter Actuator X+Y](#) \ Parameter window [Automatic sun protection](#) \ Parameter [Parameter setting](#) \ Option [Individual](#)
- The parameter is in the parameter window [Shutter Actuator X+Y](#) \ parameter window [Automatic sun protection](#).

7.4.147 Reaction on Scene recall

This parameter is used to define the reaction of the output on Scene recall.

The Scene recall does not necessarily lead to the position of the relay contact changing.

i Note

Whether the relay contact is opened or closed depends on the following factors:

- Parameterization of the output → [Function diagram Switch Actuator, Page 87](#)
- Priorities → [Priorities, Page 281](#)
- Setting in the parameter [Reaction of output](#)

Option

<u>On</u>	This acts like an On telegram on the Group Object Switch .
<u>Off</u>	This acts like an Off telegram on the Group Object Switch .

Prerequisites for visibility

- Parameter window [Configuration](#)
 - Parameter [Enable output X + Y](#) \ Option *Yes*
 - Parameter [Application](#) \ Option *Switch Actuator*
- Parameter window [Switch Actuator X](#) \ Parameter window [Functions Switch Actuator](#) \ Parameter [Enable function Scenes \[Switch Actuator\]](#) \ Option *Yes*
- Parameter window [Switch Actuator X](#) \ Parameter window [Scene assignments \[Switch Actuator\]](#)
 - Parameter [Parameter setting](#) \ Option *Individual*
 - Parameter [Enable Scene assignment x \[Switch Actuator\]](#) \ Option *Yes*
- The parameter is in the parameter window [Switch Actuator X](#) \ parameter window [Scene assignments \[Switch Actuator\]](#).

7.4.148 Reaction of output

This parameter is used to define how the output reacts on receipt of a switching telegram on the Group Object [Switch](#).

Option

<u>NC contact</u>	The relay contact is opened with an On telegram (1) and closed with an Off telegram (0).
<u>NO contact</u>	The relay contact is closed with an On telegram (1) and opened with an Off telegram (0).

Prerequisites for visibility

- Parameter window [Configuration](#)
 - Parameter [Enable output X + Y](#) \ Option *Yes*
 - Parameter [Application](#) \ Option *Switch Actuator*
- Parameter window [Switch Actuator X](#) \ Parameter window [Basic settings \[Switch Actuator\]](#) \ Parameter [Parameter setting](#) \ Option *Individual*
- The parameter is in the parameter window [Switch Actuator X](#) \ [Basic settings \[Switch Actuator\]](#).

7.4.149 Reaction after flashing

This parameter is used to define the position of the relay contact after the end of the function *Flashing*.

Ending the function does not necessarily lead to the position of the relay contact changing.

i Note

Whether the relay contact is opened or closed depends on the following factors:

- Parameterization of the output → [Function diagram Switch Actuator, Page 87](#)
- Priorities → [Priorities, Page 281](#)
- Setting in the parameter *Reaction of output*

Option	
<i>Off</i>	This acts like an Off telegram on the Group Object Switch .
<i>On</i>	This acts like an On telegram on the Group Object Switch .
<i>Refreshed KNX state</i>	The refreshed KNX state is used. → Refreshed KNX state, Page 291

Prerequisites for visibility

- Parameter window [Configuration](#)
 - Parameter [Enable output X + Y](#) \ Option *Yes*
 - Parameter [Application](#) \ Option *Switch Actuator*
- Parameter window [Switch Actuator X](#) \ Parameter window [Functions Switch Actuator](#) \ Parameter [Enable function Time](#) \ Option *Flashing*
- Parameter window [Switch Actuator X](#) \ Parameter window [Flashing](#) \ Parameter [Parameter setting](#) \ Option *Individual*
- The parameter is in the parameter window [Switch Actuator X](#) \ parameter window [Flashing](#).

7.4.150

Reaction after bus voltage recovery [Shutter Actuator]

This parameter is used to define the reaction of the Blind/Shutter after bus voltage recovery.



CAUTION

If the function *Logic* or the function *Threshold* is connected to the output, an unexpected Blind/Shutter direction change may occur after bus voltage recovery and after ETS download.

- ▶ Select option *Stop*.

Option	
<i>Stop</i>	Acts like a Stop telegram on one of the following Group Objects: <ul style="list-style-type: none"> • Stop Up/Down • Slat adjustment / Stop Up/Down
<i>Up</i>	Acts like an Up telegram on the Group Object Move Blind/Shutter Up/Down .
<i>Down</i>	Acts like a Down telegram on the Group Object Move Blind/Shutter Up/Down .
<i>Individual position</i>	The required positions of the Blind/Shutter and slats (depending on operating mode) can be defined in separate parameters. <p>The following dependent parameters are shown:</p> <ul style="list-style-type: none"> • Position height (0 % = top; 100 % = bottom) • Position slat (0 % = open; 100 % = closed)
<i>Activation of Automatic sun protection</i>	The function <i>Automatic sun protection</i> is activated.

Prerequisites for visibility

- Parameter window [Configuration](#)
 - Parameter [Enable output X + Y](#) \ Option *Yes*
 - Parameter [Application](#) \ Option *Shutter Actuator*
- Parameter window [Shutter Actuator X+Y](#) \ Parameter window [Basic settings \[Shutter Actuator\]](#) \ Parameter [Parameter setting](#) \ Option *Individual*
- The parameter is in the parameter window [Shutter Actuator X+Y](#) \ parameter window [Basic settings \[Shutter Actuator\]](#).

7.4.151 Reaction after bus voltage recovery [Switch Actuator]

This parameter is used to define the reaction after bus voltage recovery.



CAUTION

If the function *Logic* or the function *Threshold* is connected to the output, double switching behavior may occur after bus voltage recovery and after ETS download.

- ▶ Select option *Calculate contact position*.

Note

Writing to the Group Object *Switch* does not necessarily result in a change to the position of the relay contact due to the priorities and the parameterization of the output.

The value of the Group Object *Switch* can be read correctly only after a new value has been received via the bus (ABB i-bus® KNX).

Note

The relay contact position must be known to the device to ensure the following functions:

- Sending the status via the Group Object *Status Switch*

The relay contact position is known to the device if one of the following conditions is met after bus voltage recovery or ETS download.

- Reception of a switch telegram via the bus (ABB i-bus® KNX)
- Specification of the value on the Group Object *Switch* with corresponding parametrization
- Specification of the contact position by one of the safety functions or by the function *Load shedding*

Option

<i>Write Group Object "Switch" with 0</i>	The value 0 is written to the Group Object.
<i>Write Group Object "Switch" with 1</i>	The value 1 is written to the Group Object.
<i>Calculate contact position</i>	<p>The position of the relay contact is calculated in the following situations:</p> <ul style="list-style-type: none"> • If the function <i>Staircase lighting</i> was active before bus voltage failure or download, the function is activated, the relay contact switched to the corresponding position and the staircase lighting time restarted. • If a safety function is active, the relay contact is switched to the position specified with the highest priority in the safety function → Switch Actuator safety functions, Page 91. • When a load shedding stage is active, the relay contact is switched to the defined position → Parameter Switching reaction on active load shedding stage. • If the position of the relay contact has been changed by mechanical action, the last contact position known to the device is set. <p>In all other cases, the current contact position remains unchanged and the contact position is unknown to the device.</p>
<i>Switching only if safety function active</i>	<p>If a safety function is active, the relay contact is switched to the position specified with the highest priority in the safety function → Switch Actuator safety functions, Page 91.</p> <p>If no safety function is active, the current contact position remains unchanged and the relay contact position is unknown to the device.</p>

Prerequisites for visibility

- Parameter window [Configuration](#)
 - Parameter [Enable output X + Y](#) \ Option *Yes*
 - Parameter [Application](#) \ Option *Switch Actuator*
- Parameter window [Switch Actuator X](#) \ Parameter window [Basic settings \[Switch Actuator\]](#) \ Parameter [Parameter setting](#) \ Option *Individual*
- The parameter is in the parameter window [Switch Actuator X](#) \ [Basic settings \[Switch Actuator\]](#).

7.4.152 Reaction after ETS download [Shutter Actuator]

This parameter is used to define the Blind/Shutter reaction after an ETS download.

**CAUTION**

If the function *Logic* or the function *Threshold* is connected to the output, an unexpected Blind/Shutter direction change may occur after bus voltage recovery and after ETS download.

- ▶ Select option *Stop*.

Option	
<i>Up</i>	Acts like an Up telegram on the Group Object Move Blind/Shutter Up/Down .
<i>Down</i>	Acts like a Down telegram on the Group Object Move Blind/Shutter Up/Down .
<i>Stop</i>	Acts like a Stop telegram on one of the following Group Objects: <ul style="list-style-type: none"> • Stop Up/Down • Slat adjustment / Stop Up/Down
<i>Individual position</i>	The required positions of the Blind/Shutter and slats (depending on operating mode) can be defined in separate parameters. The following dependent parameters are shown: <ul style="list-style-type: none"> • Position height (0 % = top; 100 % = bottom) • Position slat (0 % = open; 100 % = closed)
<i>Activation of Automatic sun protection</i>	The function <i>Automatic sun protection</i> is activated.

Prerequisites for visibility

- Parameter window [Configuration](#)
 - Parameter [Enable output X + Y](#) \ Option *Yes*
 - Parameter [Application](#) \ Option *Shutter Actuator*
- Parameter window [Shutter Actuator X+Y](#) \ Parameter window [Basic settings \[Shutter Actuator\]](#) \ Parameter [Parameter setting](#) \ Option *Individual*
- The parameter is in the parameter window [Shutter Actuator X+Y](#) \ parameter window [Basic settings \[Shutter Actuator\]](#).

7.4.153**Reaction after ETS download [Switch Actuator]**

This parameter is used to define the reaction after ETS download.

**CAUTION**

If the function *Logic* or the function *Threshold* is connected to the output, double switching behavior may occur after bus voltage recovery and after ETS download.

- ▶ Select option *Calculate contact position*.

Note

Writing to the Group Object *Switch* does not necessarily result in a change to the position of the relay contact due to the priorities and the parameterization of the output.
The value of the Group Object *Switch* can be read correctly only after a new value has been received via the bus (ABB i-bus® KNX).

Note

The relay contact position must be known to the device to ensure the following functions:

- Sending the status via the Group Object *Status Switch*

The relay contact position is known to the device if one of the following conditions is met after bus voltage recovery or ETS download.

- Reception of a switch telegram via the bus (ABB i-bus® KNX)
- Specification of the value on the Group Object *Switch* with corresponding parametrization
- Specification of the contact position by one of the safety functions or by the function *Load shedding*

Option	
Write Group Object "Switch" with 0	The value 0 is written to the Group Object.
Write Group Object "Switch" with 1	The value 1 is written to the Group Object.
Calculate contact position	<p>The position of the relay contact is calculated in the following situations:</p> <ul style="list-style-type: none"> • If the function <i>Staircase lighting</i> was active before bus voltage failure or download, the function is activated, the relay contact switched to the corresponding position and the staircase lighting time restarted. • If a safety function is active, the relay contact is switched to the position specified with the highest priority in the safety function → Switch Actuator safety functions, Page 91. • When a load shedding stage is active, the relay contact is switched to the defined position → Parameter Switching reaction on active load shedding stage. • If the position of the relay contact has been changed by mechanical action, the last contact position known to the device is set. <p>In all other cases, the current contact position remains unchanged and the contact position is unknown to the device.</p>
<u>Switching only if safety function active</u>	<p>If a safety function is active, the relay contact is switched to the position specified with the highest priority in the safety function → Switch Actuator safety functions, Page 91.</p> <p>If no safety function is active, the current contact position remains unchanged and the relay contact position is unknown to the device.</p>

Prerequisites for visibility

- Parameter window [Configuration](#)
 - Parameter [Enable output X + Y](#) \ Option *Yes*
 - Parameter [Application](#) \ Option *Switch Actuator*
- Parameter window [Switch Actuator X](#) \ Parameter window [Basic settings \[Switch Actuator\]](#) \ Parameter [Parameter setting](#) \ Option *Individual*
- The parameter is in the parameter window [Switch Actuator X](#) \ [Basic settings \[Switch Actuator\]](#).

7.4.154

Delay

This parameter is used to define the delay with which the Scene is run after a Scene recall.

i Note

The delay can be blocked with the Group Object [Block delay for switching on and off](#).

i Note

If a delay is used for Scene recall (→ parameter [Delay](#)), the output does not react to the functions [Staircase lighting](#) and [Delay for switching on and off](#) → [Function diagram Switch Actuator, Page 87](#).

Option

00:00:00... 12:00:00 hh:mm:ss

Prerequisites for visibility

Configuration as Shutter Actuator

- Parameter window [Configuration](#)
 - Parameter [Enable output X + Y](#) \ Option *Yes*
 - Parameter [Application](#) \ Option *Shutter Actuator*
- Parameter window [Shutter Actuator X+Y](#) \ Parameter window [Shutter Actuator functions](#) \ Parameter [Enable function Scenes \[Shutter Actuator\]](#) \ Option *Yes*
- Parameter window [Shutter Actuator X+Y](#) \ Parameter window [Scene assignments \[Shutter Actuator\]](#)
 - Parameter [Parameter setting](#) \ Option *Individual*
 - Parameter [Enable Scene assignment x \[Shutter Actuator\]](#) \ Option *Yes*
- The parameter is in the parameter window [Shutter Actuator X+Y](#) \ parameter window [Scene assignments \[Shutter Actuator\]](#).

or

Configuration as Switch Actuator

- Parameter window [Configuration](#)
 - Parameter [Enable output X + Y](#) \ Option *Yes*
 - Parameter [Application](#) \ Option *Switch Actuator*
- Parameter window [Switch Actuator X](#) \ Parameter window [Functions Switch Actuator](#) \ Parameter [Enable function Scenes \[Switch Actuator\]](#) \ Option *Yes*
- Parameter window [Switch Actuator X](#) \ Parameter window [Scene assignments \[Switch Actuator\]](#)
 - Parameter [Parameter setting](#) \ Option *Individual*
 - Parameter [Enable Scene assignment x \[Switch Actuator\]](#) \ Option *Yes*
- The parameter is in the parameter window [Switch Actuator X](#) \ parameter window [Scene assignments \[Switch Actuator\]](#).

7.4.155 Delay for sun = 0

This parameter is used to define the delay time after which the Blind/Shutter is moved into position if the sun is no longer shining. This can serve to avoid unnecessary position changes due to brief periods of cloud shadowing.

Option

00:00:00... 01:40:00 hh:mm:ss

Prerequisites for visibility

- Parameter window [Configuration](#)
 - Parameter [Enable output X + Y](#) \ Option *Yes*
 - Parameter [Application](#) \ Option *Shutter Actuator*
- Parameter window [Shutter Actuator X+Y](#) \ Parameter window [Shutter Actuator functions](#) \ Parameter [Enable function Automatic sun protection](#) \ Option *Yes*
- Parameter window [Shutter Actuator X+Y](#) \ Parameter window [Automatic sun protection](#) \ Parameter [Parameter setting](#) \ Option *Individual*
- The parameter is in the parameter window [Shutter Actuator X+Y](#) \ parameter window [Automatic sun protection](#).

7.4.156 Delay for sun = 1

This parameter is used to define the delay time after which the Blind/Shutter is moved into position if the sun is shining. This can serve to avoid unnecessary position changes due to brief periods of sunshine on cloudy days.

Option

00:00:00... 01:40:00 hh:mm:ss

Prerequisites for visibility

- Parameter window [Configuration](#)
 - Parameter [Enable output X + Y](#) \ Option *Yes*
 - Parameter [Application](#) \ Option *Shutter Actuator*
- Parameter window [Shutter Actuator X+Y](#) \ Parameter window [Shutter Actuator functions](#) \ Parameter [Enable function Automatic sun protection](#) \ Option *Yes*
- Parameter window [Shutter Actuator X+Y](#) \ Parameter window [Automatic sun protection](#) \ Parameter [Parameter setting](#) \ Option *Individual*
- The parameter is in the parameter window [Shutter Actuator X+Y](#) \ parameter window [Automatic sun protection](#).

7.4.157 Delay time for drive

This parameter is used to define whether the default delay times or the user-defined delay times are to be used.

More information: → [Start-up and coasting delay and minimum run time, Page 286](#).

Option	
<i>Default</i>	The following delays are used: <ul style="list-style-type: none"> • Start-up delay: 0 ms • Coasting delay: 0 ms • Minimum run time for drive: 50 ms
<i>User-defined</i>	The delays can be set individually. The default settings need to be changed only if the Blind/Shutter is to be positioned very exactly.

Prerequisites for visibility

- Parameter window [Configuration](#)
 - Parameter [Enable output X + Y](#) \ Option *Yes*
 - Parameter [Application](#) \ Option *Shutter Actuator*
- Parameter window [Shutter Actuator X+Y](#) \ Parameter window [Drive](#) \ Parameter [Parameter setting](#) \ Option *Individual*
- The parameter is in the parameter window [Shutter Actuator X+Y](#) \ parameter window [Drive](#).

7.4.158 Total turning of slats after down movement

This parameter is used to define whether the slats are fully adjusted after a down movement of the Blind/Shutter.

This function is required mainly to release jammed slats between the panes of a window.

Option	
<i>No</i>	The slats are not adjusted after a down movement.
<i>Yes</i>	The slats are fully adjusted once (closed – open – closed) after a down movement. The slats are not adjusted if a down movement is interrupted by a stop command.

Prerequisites for visibility

- Parameter window [Configuration](#) \ Parameter [Enable output X + Y](#) \ Option *Yes*
- Parameter window [Shutter Actuator X+Y](#) \ Parameter window [Shutter Actuator functions](#)
 - Parameter [Application](#) \ Option *Shutter Actuator*
 - Parameter [Operating mode](#) \ Option *Blind/Shutter control with slat adjustment*
- Parameter window [Shutter Actuator X+Y](#) \ Parameter window [Blind/Shutter](#) \ Parameter [Parameter setting](#) \ Option *Individual*
- The parameter is in the parameter window [Shutter Actuator X+Y](#) \ parameter window [Blind/Shutter](#).

7.4.159 Warning before switching off the staircase lighting

This parameter is used to define whether a warning is provided before switching off the output.

More information: → [Function Staircase lighting, Page 104](#).

Option	
<i>No</i>	The output is switched off after the staircase lighting time has elapsed.
<i>Via Group Object</i>	<p>After the staircase lighting time has elapsed, a warning is provided via Group Object.</p> <p>The following dependent parameters are shown:</p> <ul style="list-style-type: none"> • Warning time <p>The following dependent Group Objects are displayed:</p> <ul style="list-style-type: none"> • Warning staircase lighting
<i>Short switching off</i>	<p>The output is switched off briefly after the staircase lighting time has elapsed.</p> <p>The following dependent parameters are shown:</p> <ul style="list-style-type: none"> • Number of Off/On changes • Warning time
<i>Via Group Object and short switching off</i>	<p>After the staircase lighting time has elapsed, a warning is provided via Group Object and the output switched off briefly.</p> <p>The following dependent parameters are shown:</p> <ul style="list-style-type: none"> • Number of Off/On changes • Warning time <p>The following dependent Group Objects are displayed:</p> <ul style="list-style-type: none"> • Warning staircase lighting

Prerequisites for visibility

- Parameter window [Configuration](#)
 - Parameter [Enable output X + Y](#) \ Option *Yes*
 - Parameter [Application](#) \ Option *Switch Actuator*
- Parameter window [Switch Actuator X](#) \ Parameter window [Functions Switch Actuator](#) \ Parameter [Enable function Time](#) \ Option *Staircase lighting*
- Parameter window [Switch Actuator X](#) \ Parameter window [Staircase lighting](#) \ Parameter [Parameter setting](#) \ Option *Individual*
- The parameter is in the parameter window [Switch Actuator X](#) \ parameter window [Staircase lighting](#).

7.4.160 Warning time

This parameter is used to define the duration of the warning time. The warning time starts after the staircase lighting time has elapsed.

More information: → [Function Staircase lighting, Page 104](#).

Option
00:00:10 ... 00:00:45 ... 18:12:15 hh:mm:ss

Prerequisites for visibility

- Parameter window [Configuration](#)
 - Parameter [Enable output X + Y](#) \ Option *Yes*
 - Parameter [Application](#) \ Option *Switch Actuator*
- Parameter window [Switch Actuator X](#) \ Parameter window [Functions Switch Actuator](#) \ Parameter [Enable function Time](#) \ Option *Staircase lighting*
- Parameter window [Switch Actuator X](#) \ Parameter window [Staircase lighting](#)
 - Parameter [Parameter setting](#) \ Option *Individual*
 - Parameter [Warning before switching off the staircase lighting](#) \ all options except *No*
- The parameter is in the parameter window [Switch Actuator X](#) \ parameter window [Staircase lighting](#).

7.4.161 Send value of Group Object "Status Operability"

This parameter is used to define when the value of the following Group Object is sent on the bus (ABB i-bus® KNX):

- [Status Operability](#)

Note

If one of the following options is selected, the value of the Group Object is sent after blocking or enabling KNX operation:

- *On change*
- *On change or on request*

Note

Sending on request can be triggered by the reception of a telegram with the value 0 or 1 on Group Object [Request status values](#).

Option	
<i>No, update only</i>	The value is updated but is not sent.
<i>On change</i>	The value is sent if there is a change.
<i>On request</i>	The value is sent on request.
<i>On change or on request</i>	The value is sent on change or on request.

Prerequisites for visibility

- Parameter window [Configuration](#)
 - Parameter [Enable output X + Y](#) \ Option *Yes*
 - Parameter [Application](#) \ Option *Shutter Actuator*
- Parameter window [Shutter Actuator X+Y](#) \ Parameter window [status messages](#)
 - Parameter [Parameter setting](#) \ Option *Individual*
 - Parameter [Enable Group Object "Status Operability"](#) \ Option *Yes*
- The parameter is in the parameter window [Shutter Actuator X+Y](#) \ parameter window [status messages](#).

7.4.162 Send value of Group Object "Status Result"

This parameter is used to define when the value of the following Group Object is sent on the bus (ABB i-bus® KNX):

- [Status Result \[Logic\]](#)

Note

Sending on request can be triggered by the reception of a telegram with the value 0 or 1 on Group Object [Request status values](#).

Option	
<i>No, update only</i>	The value is updated but is not sent.
<i>On change</i>	The value is sent if there is a change.
<i>On request</i>	The value is sent on request.
<i>On change or on request</i>	The value is sent on change or on request.
<i>After receiving input value</i>	The value is sent on the input Group Objects after reception of a telegram. The result is recalculated due to the reception of a telegram on the input Group Objects, the result does not necessarily need to change.
<i>After receiving input value or on request</i>	The value is sent on the input Group Objects after reception of a telegram or on request. The result is recalculated due to the reception of a telegram on the input Group Objects, the result does not necessarily need to change.

Prerequisites for visibility

- Parameter window [Configuration](#) \ Parameter [Enable Logic/Threshold x-y](#) \ Option *Yes*
- Parameter window [Logic/Threshold](#) \ Parameter window [Logic/Threshold x](#)
 - Parameter [Function of the logic gate](#) \ Options *AND / OR / Exclusive OR / GATE / 1 bit Inverter*
 - Parameter [Enable Group Object "Status Result"](#) \ Option *Yes*
- The parameter is in the parameter window [Logic/Threshold](#) \ parameter window [Logic/Threshold x](#).

7.4.163

Send value of Group Object "Status Load shedding"

This parameter is used to define when the value of the following Group Object is sent on the bus (ABB i-bus® KNX):

- [Status Load shedding](#)

Note

Sending on request can be triggered by the reception of a telegram with the value 0 or 1 on Group Object [Request status values](#).

Option	
<i>No, update only</i>	The value is updated but is not sent.
<i>On change</i>	The value is sent if there is a change.
<i>On request</i>	The value is sent on request.
<i>On change or on request</i>	The value is sent on change or on request.

Prerequisites for visibility

- Parameter window [Configuration](#) \
 - Parameter [Enable output X + Y](#) \ Option *Yes*
 - Parameter [Application](#) \ Option *Switch Actuator*
- Parameter window [Device settings](#) \ Parameter [Enable central Group Object "Receive load shedding stage"](#) \ Option *Yes*
- Parameter window [Switch Actuator X](#) \ Parameter window [Functions Switch Actuator](#) \ Parameter [Enable function Load shedding](#) \ Option *Yes*
- Parameter window [Switch Actuator X](#) \ Parameter window [Load shedding](#)
 - Parameter [Parameter setting](#) \ Option *Individual*
 - Parameter [Enable group object "Status Load shedding"](#) \ Option *Yes*
- The parameter is in the parameter window [Switch Actuator X](#) \ parameter window [Load shedding](#).

7.4.164 Value of Group Object "Status Switch"

This parameter is used to define the value adopted by the Group Object *Status Switch* depending on the position of the relay contact.

Option	
<i>1: closed, 0: open</i>	The Group Object has the value 1 when the relay contact is closed. The Group Object has the value 0 when the relay contact is open.
<i>0: closed, 1: open</i>	The Group Object has the value 0 when the relay contact is closed. The Group Object has the value 1 when the relay contact is open.

Prerequisites for visibility

- Parameter window *Configuration*
 - Parameter *Enable output X + Y* \ Option *Yes*
 - Parameter *Application* \ Option *Switch Actuator*
- Parameter window *Switch Actuator X* \ Parameter window *Basic settings [Switch Actuator]*
 - Parameter *Parameter setting* \ Option *Individual*
 - Parameter *Feedback of contact position via Group Object "Status Switch"* \ Option *Yes*
- The parameter is in the parameter window *Switch Actuator X* \ *Basic settings [Switch Actuator]*.

7.4.165 Send value of Group Object "Status Switch"

This parameter is used to define when the value of the following Group Object is sent on the bus (ABB i-bus® KNX):

- *Status Switch*

Note

If one of the following options is selected, the value of the Group Object is sent for each switching operation:

- *On change*
- *On change or on request*

Note

Sending on request can be triggered by the reception of a telegram with the value 0 or 1 on Group Object *Request status values*.

Option	
<i>No, update only</i>	The value is updated but is not sent.
<i>On change</i>	The value is sent if there is a change.
<i>On request</i>	The value is sent on request.
<i>On change or on request</i>	The value is sent on change or on request.

Prerequisites for visibility

- Parameter window *Configuration*
 - Parameter *Enable output X + Y* \ Option *Yes*
 - Parameter *Application* \ Option *Switch Actuator*
- Parameter window *Switch Actuator X* \ Parameter window *Basic settings [Switch Actuator]*
 - Parameter *Parameter setting* \ Option *Individual*
 - Parameter *Feedback of contact position via Group Object "Status Switch"* \ Option *Yes*
- The parameter is in the parameter window *Switch Actuator X* \ *Basic settings [Switch Actuator]*.

7.4.166 Send value of Group Object "Status Automatic sun protection"

This parameter is used to define when the value of the following Group Object is sent on the bus (ABB i-bus® KNX):

- [Status Automatic sun protection](#)

i Note

If one of the following options is selected, the value of the Group Object is sent after the activation or deactivation of Automatic sun protection:

- *On change*
- *On change or on request*

i Note

Sending on request can be triggered by the reception of a telegram with the value 0 or 1 on Group Object [Request status values](#).

Option	
<i>No, update only</i>	The value is updated but is not sent.
<i>On change</i>	The value is sent if there is a change.
<i>On request</i>	The value is sent on request.
<i>On change or on request</i>	The value is sent on change or on request.

Prerequisites for visibility

- Parameter window [Configuration](#)
 - Parameter [Enable output X + Y](#) \ Option Yes
 - Parameter [Application](#) \ Option [Shutter Actuator](#)
- Parameter window [Shutter Actuator X+Y](#) \ Parameter window [Shutter Actuator functions](#) \ Parameter [Enable function Automatic sun protection](#) \ Option Yes
- Parameter window [Shutter Actuator X+Y](#) \ Parameter window [status messages](#)
 - Parameter [Parameter setting](#) \ Option [Individual](#)
 - Parameter [Enable Group Object "Status Automatic sun protection"](#) \ Option Yes
- The parameter is in the parameter window [Shutter Actuator X+Y](#) \ parameter window [status messages](#).

7.4.167 Value of Group Object "Connection A" after bus voltage recovery

This parameter is used to define the value that is written to the Group Object [Connection A](#) after bus voltage recovery.

Option	
<i>1</i>	The value 1 is written to the Group Object. Writing the Group Object does not affect the result of the function Logic .
<i>0</i>	The value 0 is written to the Group Object. Writing the Group Object does not affect the result of the function Logic .

Prerequisites for visibility

- Parameter window [Configuration](#) \ Parameter [Enable Logic/Threshold x-y](#) \ Option Yes
- Parameter window [Logic/Threshold](#) \ Parameter window [Logic/Threshold x](#) \ Parameter [Function of the logic gate](#) \ Options [AND](#) / [OR](#) / [Exclusive OR](#) / [GATE](#) / [1 bit Inverter](#)
- The parameter is in the parameter window [Logic/Threshold](#) \ parameter window [Logic/Threshold x](#).

7.4.168 Value of Group Object "Connection B" after bus voltage recovery

This parameter is used to define the value that is written to the Group Object *Connection B* after bus voltage recovery.

Option	
1	The value 1 is written to the Group Object. Writing the Group Object does not affect the result of the function <i>Logic</i> .
0	The value 0 is written to the Group Object. Writing the Group Object does not affect the result of the function <i>Logic</i> .

Prerequisites for visibility

- Parameter window *Configuration* \ Parameter *Enable Logic/Threshold x-y* \ Option *Yes*
- Parameter window *Logic/Threshold* \ Parameter window *Logic/Threshold x* \ Parameter *Function of the logic gate* \ Options *AND / OR / Exclusive OR / GATE*
- The parameter is in the parameter window *Logic/Threshold* \ parameter window *Logic/Threshold x*.

7.4.169 Send value of Group Objects "Status Upper/Lower end position"

This parameter is used to define when the values of the following Group Objects are sent on the bus (ABB i-bus® KNX):

- *Status Upper end position*
- *Status Lower end position*

i Note

If one of the following options is selected, the value of the Group Objects is sent after reaching or leaving the Upper/Lower end position:

- *On change*
- *On change or on request*

i Note

Sending on request can be triggered by the reception of a telegram with the value 0 or 1 on Group Object *Request status values*.

Option	
<i>No, update only</i>	The value is updated but is not sent.
<i>On change</i>	The value is sent if there is a change.
<i>On request</i>	The value is sent on request.
<i>On change or on request</i>	The value is sent on change or on request.

Prerequisites for visibility

- Parameter window *Configuration*
 - Parameter *Enable output X + Y* \ Option *Yes*
 - Parameter *Application* \ Option *Shutter Actuator*
- Parameter window *Shutter Actuator X+Y* \ Parameter window *status messages*
 - Parameter *Parameter setting* \ Option *Individual*
 - Parameter *Enable Group Objects "Status Upper/Lower end position"* \ Option *Yes*
- The parameter is in the parameter window *Shutter Actuator X+Y* \ parameter window *status messages*.

7.4.170 Send value of Group Objects "Status Height/Slat"

This parameter is used to define when the values of the following Group Objects are sent on the bus (ABB i-bus® KNX):

- [Status Height](#)
- [Status Slat](#)

i Note

The Group Object [Status Slat](#) is visible only in the operating mode *Blind/Shutter control with slat adjustment*.

i Note

If one of the following options is selected, the value of the Group Objects is sent after the completion of a movement:

- *On change*
- *On change or on request*

i Note

Sending on request can be triggered by the reception of a telegram with the value 0 or 1 on Group Object [Request status values](#).

Option

<i>No, update only</i>	The value is updated but is not sent.
<i>On change</i>	The value is sent if there is a change.
<i>On request</i>	The value is sent on request.
<i>On change or on request</i>	The value is sent on change or on request.

Prerequisites for visibility

- Parameter window [Configuration](#)
 - Parameter [Enable output X + Y](#) \ Option *Yes*
 - Parameter [Application](#) \ Option *Shutter Actuator*
- Parameter window [Shutter Actuator X+Y](#) \ Parameter window [status messages](#)
 - Parameter [Parameter setting](#) \ Option *Individual*
 - Parameter [Enable Group Objects "Status Height/Slat"](#) \ Option *Yes*
- The parameter is in the parameter window [Shutter Actuator X+Y](#) \ parameter window [status messages](#).

7.4.171 Send value of Group Objects "Status byte" [Shutter Actuator]

This parameter is used to define when the values of the following Group Objects are sent on the bus (ABB i-bus® KNX):

- [Status byte all active priorities](#)
- [Status byte highest active priority](#)

i Note

If one of the following options is selected, the value of the Group Object is sent for each change in a value:

- *On change*
- *On change or on request*

i Note

Sending on request can be triggered by the reception of a telegram with the value 0 or 1 on Group Object [Request status values](#).

Option	
<i>No, update only</i>	The value is updated but is not sent.
<i>On change</i>	The value is sent if there is a change.
<i>On request</i>	The value is sent on request.
<i>On change or on request</i>	The value is sent on change or on request.

Prerequisites for visibility

- Parameter window [Configuration](#)
 - Parameter [Enable output X + Y](#) \ Option *Yes*
 - Parameter [Application](#) \ Option *Shutter Actuator*
- Parameter window [Shutter Actuator X+Y](#) \ Parameter window [status messages](#)
 - Parameter [Parameter setting](#) \ Option *Individual*
 - Parameter [Enable Group Objects "Status byte" \[Shutter Actuator\]](#) \ Options *Yes, all active priorities / Yes, highest active priority*
- The parameter is in the parameter window [Shutter Actuator X+Y](#) \ parameter window [status messages](#).

7.4.172 Send value of Group Objects "Status byte" [Switch Actuator]

This parameter is used to define when the values of the following Group Objects are sent on the bus (ABB i-bus® KNX):

- [Status byte all active priorities](#)
- [Status byte highest active priority](#)

i Note

If one of the following options is selected, the value of the Group Object is sent for each change in a value:

- *On change*
- *On change or on request*

i Note

Sending on request can be triggered by the reception of a telegram with the value 0 or 1 on Group Object [Request status values](#).

Option	
<i>No, update only</i>	The value is updated but is not sent.
<i>On change</i>	The value is sent if there is a change.
<i>On request</i>	The value is sent on request.
<i>On change or on request</i>	The value is sent on change or on request.

Prerequisites for visibility

- Parameter window [Configuration](#)
 - Parameter [Enable output X + Y](#) \ Option *Yes*
 - Parameter [Application](#) \ Option *Switch Actuator*
- Parameter window [Switch Actuator X](#) \ Parameter window [Basic settings \[Switch Actuator\]](#)
 - Parameter [Parameter setting](#) \ Option *Individual*
 - Parameter [Enable Group Objects "Status byte" \[Switch Actuator\]](#) \ Options *Yes, all active priorities / Yes, highest active priority*
- The parameter is in the parameter window [Switch Actuator X](#) \ [Basic settings \[Switch Actuator\]](#).

7.4.173 Value after sending and switching delay has expired

This parameter is used to define the values that are applicable at the inputs and outputs after expiration of the sending and switching delay.

Option	
<i>Last value received</i>	The inputs and outputs react to the last value received.
<i>Ignore received values</i>	The state of the inputs and outputs remains unchanged until a new value is received after the sending and switching delays have elapsed.

Prerequisites for visibility

- The parameter is in the parameter window [Device settings](#).

7.4.174 Send values of Group Objects "Status Result" and "Status Input value between thresholds"

This parameter is used to define when the values of the following Group Objects are sent on the bus (ABB i-bus® KNX):

- [Status Result \[Threshold\]](#)
- [Status Input value between thresholds](#)

Note

Sending on request can be triggered by the reception of a telegram with the value 0 or 1 on Group Object [Request status values](#).

Option	
<i>No, update only</i>	The value is updated but is not sent.
<i>On change</i>	The value is sent if there is a change.
<i>On request</i>	The value is sent on request.
<i>On change or on request</i>	The value is sent on change or on request.
<i>After receiving input value</i>	The value is sent on the input Group Objects after reception of a telegram. The result is recalculated due to the reception of a telegram on the input Group Objects, the result does not necessarily need to change.
<i>After receiving input value or on request</i>	The value is sent on the input Group Objects after reception of a telegram or on request. The result is recalculated due to the reception of a telegram on the input Group Objects, the result does not necessarily need to change.

Prerequisites for visibility

- Parameter window [Configuration](#) \ Parameter [Enable Logic/Threshold x-y](#) \ Option *Yes*
- Parameter window [Logic/Threshold](#) \ Parameter window [Logic/Threshold x](#)
 - Parameter [Function of the logic gate](#) \ Option *Threshold*
 - Parameter [Enable Group Objects "Status Result" and "Status Input value between thresholds"](#) \ Option *Yes*
- The parameter is in the parameter window [Logic/Threshold](#) \ [Logic/Threshold x](#).

7.4.175 Time for off

This parameter is used to define how long the output remains switched off during a flashing cycle.

Option
<i>00:00:01 ... 00:00:05 ... 18:12:15 hh:mm:ss</i>

Prerequisites for visibility

- Parameter window [Configuration](#)
 - Parameter [Enable output X + Y](#) \ Option *Yes*
 - Parameter [Application](#) \ Option *Switch Actuator*
- Parameter window [Switch Actuator X](#) \ Parameter window [Functions Switch Actuator](#) \ Parameter [Enable function Time](#) \ Option *Flashing*
- Parameter window [Switch Actuator X](#) \ Parameter window [Flashing](#) \ Parameter [Parameter setting](#) \ Option *Individual*
- The parameter is in the parameter window [Switch Actuator X](#) \ parameter window [Flashing](#).

7.4.176 Time for automatic reactivation of Automatic sun protection

The parameter is used to define the time after which the function *Automatic sun protection* is reactivated automatically.

i Note

This parameter only has an effect if the function *Automatic sun protection* has been deactivated by the receipt of a direct command.

Option

00:10:00 ... 05:00:00 ... 99:59:59 hh:mm:ss

Prerequisites for visibility

- Parameter window [Configuration](#) \ Parameter [Enable output X + Y](#) \ Option Yes
- Parameter window [Shutter Actuator X+Y](#) \ Parameter window [Shutter Actuator functions](#)
 - Parameter [Application](#) \ Option [Shutter Actuator](#)
 - Parameter [Enable function Automatic sun protection](#) \ Option Yes
- Parameter window [Shutter Actuator X+Y](#) \ Parameter window [Automatic sun protection](#)
 - Parameter [Parameter setting](#) \ Option [Individual](#)
 - Parameter [Deactivation of Automatic sun protection](#) \ Option [Via Group Object or direct command](#)
 - Parameter [Automatic reactivation of Automatic sun protection](#) \ Option Yes
- The parameter is in the parameter window [Shutter Actuator X+Y](#) \ parameter window [Automatic sun protection](#).

7.4.177 Time for on

This parameter is used to define how long the output remains switched on during a flashing cycle.

Option

00:00:01 ... 00:00:05 ... 18:12:15 hh:mm:ss

Prerequisites for visibility

- Parameter window [Configuration](#)
 - Parameter [Enable output X + Y](#) \ Option Yes
 - Parameter [Application](#) \ Option [Switch Actuator](#)
- Parameter window [Switch Actuator X](#) \ Parameter window [Functions Switch Actuator](#) \ Parameter [Enable function Time](#) \ Option [Flashing](#)
- Parameter window [Switch Actuator X](#) \ Parameter window [Flashing](#) \ Parameter [Parameter setting](#) \ Option [Individual](#)
- The parameter is in the parameter window [Switch Actuator X](#) \ parameter window [Flashing](#).

7.4.178 Enable central Group Objects "Shutter"

This parameter is used to enable the following central Shutter Group Objects:

- [Move Blind/Shutter Up/Down](#)
- [Slat adjustment / Stop Up/Down](#)
- [Move to position height](#)
- [Move to position slat](#)

All assigned outputs can be activated together with the central Group Objects.

Note

Observe the maximum number of switching cycles per minute when using central Group Objects → Technical data.

Option

<u>No</u>	The Group Objects will not be enabled.
<u>Yes</u>	The following dependent Group Objects are displayed: <ul style="list-style-type: none"> • Move Blind/Shutter Up/Down • Slat adjustment / Stop Up/Down • Move to position height • Move to position slat

Prerequisites for visibility

- The parameter is in the parameter window [Device settings](#).

7.4.179 Enable central Group Object "Receive load shedding stage"

This parameter enables the central Group Object [Receive load shedding stage](#). The device can receive load shedding stages from a master via this Group Object.

All assigned outputs can be activated together with the central Group Object.

Note

Observe the maximum number of switching cycles per minute when using central Group Objects → Technical data.

Option

<u>No</u>	The Group Object is not enabled.
<u>Yes</u>	The following dependent parameters are shown: <ul style="list-style-type: none"> • Enable function Load shedding The following dependent Group Objects are displayed: <ul style="list-style-type: none"> • Receive load shedding stage

Prerequisites for visibility

- The parameter is in the parameter window [Device settings](#).

7.4.180 Enable central Group Object "Switch"

This parameter enables the central Group Object [Switch](#).

All assigned outputs can be activated together with the central Group Object.

i Note

Observe the maximum number of switching cycles per minute when using central Group Objects → [Technical data](#).

Option

<i>No</i>	The Group Object is not enabled.
<i>Yes</i>	The following dependent parameters are shown: <ul style="list-style-type: none"> • Switch output reacts to central Switch Group Object The following dependent Group Objects are displayed: <ul style="list-style-type: none"> • Switch

Prerequisites for visibility

- The parameter is in the parameter window [Device settings](#).

7.4.181 Enable central Group Object "Scene 1 ... 64"

This parameter enables the central Group Object [Scene 1 ... 64](#).

All outputs assigned to the Scene can be activated together with the central Group Object.

i Note

Observe the maximum number of switching cycles per minute when using central Group Objects → [Technical data](#).

Option

<i>No</i>	The Group Object is not enabled.
<i>Yes</i>	The following dependent Group Objects are displayed: <ul style="list-style-type: none"> • Scene 1 ... 64

Prerequisites for visibility

- The parameter is in the parameter window [Device settings](#).

7.4.182 i-bus® Tool access

This parameter is used to define whether the device can be accessed via i-bus® Tool.

More information: → [Integration into i-bus® Tool, Page 108](#).

Option

<i>Deactivated</i>	Access via i-bus® Tool is deactivated.
<i>Value display only</i>	Values can be displayed via the i-bus® Tool.
<i>Full access</i>	Values can be displayed and changed i-bus® Tool.

Prerequisites for visibility

- The parameter is in the parameter window [Configuration](#).

7.4.183 State after end of manual operation

This parameter is used to define the state of the inputs and outputs after the end of manual operation.

Option	
<i>Manually set state retained</i>	The manually set state remains active.
<i>Refreshed KNX state</i>	The manually set state is overwritten. The refreshed KNX state is used. → Refreshed KNX state, Page 291

Prerequisites for visibility

- Parameter window [Manual operation](#) \ Parameter [Enable manual operation](#) \ Option Yes
- The parameter is in the parameter window [Manual operation](#).

7.4.184 Forced operation (1 bit / 2 bit) [Shutter Actuator]

This parameter is used to Activate/Deactivate 1-bit or 2-bit forced operation.

More information: → [forced operation, Page 90](#).

Option	
<i>Deactivated</i>	Forced operation is deactivated.
<i>Activated 1 bit – 0 active</i>	<p>Forced operation is activated by the reception of a telegram with the value 0.</p> <p>The following dependent parameters are shown:</p> <ul style="list-style-type: none"> • Position height (0 % = top; 100 % = bottom) • Position slat (0 % = open; 100 % = closed) <p>The following dependent Group Objects are displayed:</p> <ul style="list-style-type: none"> • Forced operation, 1-bit
<i>Activated 1 bit – 1 active</i>	<p>Forced operation is activated by the reception of a telegram with the value 1.</p> <p>The following dependent parameters are shown:</p> <ul style="list-style-type: none"> • Position height (0 % = top; 100 % = bottom) • Position slat (0 % = open; 100 % = closed) <p>The following dependent Group Objects are displayed:</p> <ul style="list-style-type: none"> • Forced operation, 1-bit
<i>Activated 2 bit</i>	<p>2-bit forced operation is used.</p> <p>The following dependent parameters are shown:</p> <ul style="list-style-type: none"> • Forced operation active On: Position height (0 % = top; 100 % = bottom) • Forced operation active On: Position slat (0 % = open; 100 % = closed) • Forced operation active Off: Position height (0 % = top; 100 % = bottom) • Forced operation active Off: Position slat (0 % = open; 100 % = closed) <p>The following dependent Group Objects are displayed:</p> <ul style="list-style-type: none"> • Forced operation, 2-bit

Prerequisites for visibility

- Parameter window [Configuration](#)
 - Parameter [Enable output X + Y](#) \ Option Yes
 - Parameter [Application](#) \ Option [Shutter Actuator](#)
- Parameter window [Shutter Actuator X+Y](#) \ Parameter window [Shutter Actuator functions](#) \ Parameter [Enable function Safety/Weather alarms](#) \ Option Yes
- Parameter window [Shutter Actuator X+Y](#) \ Parameter window [Safety/Weather alarms](#) \ Parameter [Parameter setting](#) \ Option [Individual](#)
- The parameter is in the parameter window [Shutter Actuator X+Y](#) \ parameter window [Safety/Weather alarms](#).

7.4.185 Forced operation (1 bit / 2 bit) [Switch Actuator]

This parameter is used to Activate/Deactivate 1-bit or 2-bit forced operation.

More information: → [forced operation, Page 92](#).

Option	
<i>Deactivated</i>	Forced operation is deactivated.
<i>Activated 1 bit – 0 active</i>	<p>Forced operation is activated by the reception of a telegram with the value 0.</p> <p>The following dependent parameters are shown:</p> <ul style="list-style-type: none"> • Switching reaction on forced operation <p>The following dependent Group Objects are displayed:</p> <ul style="list-style-type: none"> • Forced operation, 1-bit
<i>Activated 1 bit – 1 active</i>	<p>Forced operation is activated by the reception of a telegram with the value 0.</p> <p>The following dependent parameters are shown:</p> <ul style="list-style-type: none"> • Switching reaction on forced operation <p>The following dependent Group Objects are displayed:</p> <ul style="list-style-type: none"> • Forced operation, 1-bit
<i>Activated 2 bit</i>	<p>2-bit forced operation is used.</p> <p>The following dependent Group Objects are displayed:</p> <ul style="list-style-type: none"> • Forced operation, 2-bit

Prerequisites for visibility

- Parameter window [Configuration](#)
 - Parameter [Enable output X + Y](#) \ Option *Yes*
 - Parameter [Application](#) \ Option *Switch Actuator*
- Parameter window [Switch Actuator X](#) \ Parameter window [Functions Switch Actuator](#) \ Parameter [Enable function Safety](#) \ Option *Yes*
- Parameter window [Switch Actuator X](#) \ Parameter window [Safety](#) \ Parameter [Parameter setting](#) \ Option *Individual*
- The parameter is in the parameter window [Switch Actuator X](#) \ parameter window [Safety](#).

7.4.186 Cyclical monitoring

This parameter is used to activate the cyclical monitoring and to define the monitoring cycle for the safety Group Objects. If the monitoring cycle is specified with the value 00:00:00, the cyclical monitoring is deactivated.

More information: → [Cyclical monitoring, Page 293](#).

Note

The monitoring cycle in the device should be at least quadruple the cyclical sending time of the sending device. As a result, the reactions set will not be triggered immediately if a signal is missing, e.g. due to high bus load.

Option
<i>00:00:00 ... 12:00:00 hh:mm:ss</i>

Prerequisites for visibility

- The parameter appears at various points in the application. The visibility is dependent on the application and the higher-level parameter.

8 Group Objects

8.1 Overview of Group Objects

Function	Group Object name	Data point type	Length	Flags
Activate/Deactivate Automatic sun protection	Channel X: Shutter	DPT 1.003	1 bit	C W T U
Activate/Deactivate limitation	Channel X: Shutter	DPT 1.0003	1 bit	C W
Block	Channel X: Shutter	DPT 1.003	1 bit	C W
Block	Channel X: Switch	DPT 1.003	1 bit	C W
Block Automatic sun protection	Channel X: Shutter	DPT 1.003	1 bit	C W T U
Block delay for switching on and off	Channel X: Switch	DPT 1.003	1 bit	C W
Block staircase lighting	Channel X: Switch	DPT 1.003	1 bit	C W
Block direct operation	Channel X: Shutter	DPT 1.003	1 bit	C W
Change lower threshold	Logic/Threshold X: Threshold	DPT 13.010	4 bytes	C W
Change lower threshold	Logic/Threshold X: Threshold	DPT 13.013	4 bytes	C W
Change lower threshold	Logic/Threshold X: Threshold	DPT 14.019	4 bytes	C W
Change lower threshold	Logic/Threshold X: Threshold	DPT 14.056	4 bytes	C W
Change lower threshold	Logic/Threshold X: Threshold	DPT 5.001	1 byte	C W
Change lower threshold	Logic/Threshold X: Threshold	DPT 5.010	1 byte	C W
Change lower threshold	Logic/Threshold X: Threshold	DPT 7.001	2 bytes	C W
Change lower threshold	Logic/Threshold X: Threshold	DPT 9.001	2 bytes	C W
Change lower threshold	Logic/Threshold X: Threshold	DPT 9.004	2 bytes	C W
Change lower threshold	Logic/Threshold X: Threshold	DPT 9.021	2 bytes	C W
Change lower threshold	Logic/Threshold X: Threshold	DPT 9.024	2 bytes	C W
Change upper threshold	Logic/Threshold X: Threshold	DPT 13.010	4 bytes	C W
Change upper threshold	Logic/Threshold X: Threshold	DPT 13.013	4 bytes	C W
Change upper threshold	Logic/Threshold X: Threshold	DPT 14.019	4 bytes	C W
Change upper threshold	Logic/Threshold X: Threshold	DPT 14.056	4 bytes	C W
Change upper threshold	Logic/Threshold X: Threshold	DPT 5.001	1 byte	C W
Change upper threshold	Logic/Threshold X: Threshold	DPT 5.010	1 byte	C W
Change upper threshold	Logic/Threshold X: Threshold	DPT 7.001	2 bytes	C W
Change upper threshold	Logic/Threshold X: Threshold	DPT 9.001	2 bytes	C W
Change upper threshold	Logic/Threshold X: Threshold	DPT 9.004	2 bytes	C W
Change upper threshold	Logic/Threshold X: Threshold	DPT 9.021	2 bytes	C W
Change upper threshold	Logic/Threshold X: Threshold	DPT 9.024	2 bytes	C W
Connection A	Logic/Threshold X: Logic	DPT 1.002	1 bit	C W
Connection B	Logic/Threshold X: Logic	DPT 1.002	1 bit	C W
Enable/Block manual operation	Manual operation: Manual operation	DPT 1.003	1 bit	C W
Ending manual operation	Manual operation: Manual operation	DPT 1.003	1 bit	C W
Flashing	Channel X: Switch	DPT 1.001	1 bit	C W
Forced operation, 1-bit	Channel X: Shutter	DPT 1.003	1 bit	C W
Forced operation, 1-bit	Channel X: Switch	DPT 1.003	1 bit	C W
Forced operation, 2-bit	Channel X: Shutter	DPT 2.001	2 bit	C W
Forced operation, 2-bit	Channel X: Switch	DPT 2.001	2 bit	C W
Frost alarm	Safety: Shutter	DPT 1.005	1 bit	C W T U
In operation	Central: General	DPT 1.002	1 bit	C R T
Move Blind/Shutter Up/Down	Central: Shutter	DPT 1.008	1 bit	C W
Move Blind/Shutter Up/Down	Channel X: Shutter	DPT 1.008	1 bit	C W
Move Blind/Shutter Up/Down limited	Channel X: Shutter	DPT 1.008	1 bit	C W
Move to position height	Central: Shutter	DPT 5.001	1 byte	C W
Move to position height	Channel X: Shutter	DPT 5.001	1 byte	C W
Move to position slat	Central: Shutter	DPT 5.001	1 byte	C W
Move to position slat	Channel X: Shutter	DPT 5.001	1 byte	C W
Rain alarm	Safety: Shutter	DPT 1.005	1 bit	C W T U
Recall Scene assignment x	Channel X: Shutter	DPT 1.017	1 bit	C W
Recall Scene assignment x	Channel X: Switch	DPT 1.017	1 bit	C W
Receive load shedding stage	Central: Load shedding	DPT 236.001	1 byte	C W
Request Date/Time	Central: Date/Time	DPT 1.017	1 bit	C T
Request status values	Central: General	DPT 1.017	1 bit	C W
Safety priority x	Safety: Switch	DPT 1.005	1 bit	C W T U
Scene 1 ... 64	Central: Scene	DPT 18.001	1 byte	C W
Scene 1 ... 64	Channel X: Shutter	DPT 18.001	1 byte	C W
Scene 1 ... 64	Channel X: Switch	DPT 18.001	1 byte	C W
Set date	Central: Date/Time	DPT 11.001	3 bytes	C W
Set date/time	Central: Date/Time	DPT 19.001	8 bytes	C W
Set load shedding stage	Channel X: Load shedding	DPT 236.001	1 byte	C W

Function	Group Object name	Data point type	Length	Flags
Set time	Central: Date/Time	DPT 10.001	3 bytes	C W
Slat adjustment / Stop Up/Down	Central: Shutter	DPT 1.007	1 bit	C W
Slat adjustment / Stop Up/Down	Channel X: Shutter	DPT 1.007	1 bit	C W
Staircase lighting permanent on	Channel X: Switch	DPT 1.001	1 bit	C W
Staircase lighting time	Channel X: Switch	DPT 7.005	2 bytes	C W
Status Automatic sun protection	Channel X: Shutter	DPT 1.011	1 bit	C R T
Status byte all active priorities	Channel X: Shutter	nonDPT	1 byte	C R T
Status byte all active priorities	Channel X: Switch	nonDPT	1 byte	C R T
Status byte highest active priority	Channel X: Shutter	nonDPT	1 byte	C R T
Status byte highest active priority	Channel X: Switch	nonDPT	1 byte	C R T
Status Height	Channel X: Shutter	DPT 5.001	1 byte	C R T
Status Input value between thresholds	Logic/Threshold X: Threshold	DPT 1.002	1 bit	C R T
Status Load shedding	Channel X: Load shedding	DPT 1.011	1 bit	C R T
Status Lower end position	Channel X: Shutter	DPT 1.011	1 bit	C R T
Status Manual operation	Manual operation: Manual operation	DPT 1.011	1 bit	C R T
Status Operability	Channel X: Shutter	DPT 1.011	1 bit	C R T
Status Result [Logic]	Logic/Threshold X: Logic	DPT 1.002	1 bit	C R T
Status Result [Threshold]	Logic/Threshold X: Threshold	DPT 1.002	1 bit	C R T
Status Slat	Channel X: Shutter	DPT 5.001	1 byte	C R T
Status Switch	Channel X: Switch	DPT 1.011	1 bit	C R T
Status Upper end position	Channel X: Shutter	DPT 1.011	1 bit	C R T
Stop Up/Down	Channel X: Shutter	DPT 1.007	1 bit	C W
Sun	Channel X: Shutter	DPT 1.002	1 bit	C W T U
Sun: Move slat	Channel X: Shutter	DPT 5.001	1 byte	C W T U
Sun: Move to height	Channel X: Shutter	DPT 5.001	1 byte	C W T U
Switch	Central: Switch	DPT 1.001	1 bit	C W
Switch	Channel X: Switch	DPT 1.001	1 bit	C W
Threshold input	Logic/Threshold X: Threshold	DPT 13.010	4 bytes	C W T U
Threshold input	Logic/Threshold X: Threshold	DPT 13.013	4 bytes	C W T U
Threshold input	Logic/Threshold X: Threshold	DPT 14.019	4 bytes	C W T U
Threshold input	Logic/Threshold X: Threshold	DPT 14.056	4 bytes	C W T U
Threshold input	Logic/Threshold X: Threshold	DPT 5.001	1 byte	C W T U
Threshold input	Logic/Threshold X: Threshold	DPT 5.010	1 byte	C W T U
Threshold input	Logic/Threshold X: Threshold	DPT 7.001	2 bytes	C W T U
Threshold input	Logic/Threshold X: Threshold	DPT 9.001	2 bytes	C W T U
Threshold input	Logic/Threshold X: Threshold	DPT 9.004	2 bytes	C W T U
Threshold input	Logic/Threshold X: Threshold	DPT 9.021	2 bytes	C W T U
Threshold input	Logic/Threshold X: Threshold	DPT 9.024	2 bytes	C W T U
Trigger reference movement	Channel X: Shutter	DPT 1.008	1 bit	C W
Warning staircase lighting	Channel X: Switch	DPT 1.001	1 bit	C R T
Wind alarm x	Safety: Shutter	DPT 1.005	1 bit	C W T U

8.2 Group Objects "Central"

Function	Group Object name	Data point type	Length	Flags
Move Blind/Shutter Up/Down	Central: Shutter	DPT 1.008	1 bit	C W

This Group Object can be used to activate several outputs of the device under central control. It can be defined individually in the parameter *Output reacts to central shutter Group Objects* for each output whether the output reacts to this Group Object.

This Group Object is used to receive, via the bus (ABB i-bus® KNX), the command for moving the Blind/Shutter. If no other movement commands are received, the Blind/Shutter is moved to the Upper/Lower end position.

Telegram value:

- 1 = Down
- 0 = Up

Note

With the functions *Weather alarms, Block, Forced operation* or *Automatic sun protection*, a telegram does not necessarily result in a change to the Blind/Shutter position.

Each relay can perform only a limited number of switching operations per minute. Frequent switching can cause a switching delay. More information → Technical data.

Prerequisites for visibility

- Parameter window *Device settings* \ Parameter *Enable central Group Objects "Shutter"* \ Option Yes

Function	Group Object name	Data point type	Length	Flags
Set date	Central: Date/Time	DPT 11.001	3 bytes	C W
This Group Object is used to receive, via the bus (ABB i-bus® KNX), the date. Telegram value: <ul style="list-style-type: none"> • DD.MM.YYYY 				
Note If this Group Object is read, it indicates the last value received. The value may vary from the current device time.				
Prerequisites for visibility <ul style="list-style-type: none"> • Parameter window Device settings \ Parameter Enable Time Group Objects for setting of device time \ Option Date (DPT 11.001)/time (10.001) 				
Request Date/Time	Central: Date/Time	DPT 1.017	1 bit	C T
This Group Object sends a date and time request on the bus (ABB i-bus® KNX). The request is sent 30 seconds after switching on the device. An active send and switching delay is not taken into account. Telegram value: <ul style="list-style-type: none"> • 1 = Trigger • 0 = Is not sent 				
Prerequisites for visibility <ul style="list-style-type: none"> • Parameter window Device settings \ Parameter Enable Time Group Objects for setting of device time \ Option Date (DPT 11.001)/time (10.001) / Date/Time (DPT 19.001) 				
Set date/time	Central: Date/Time	DPT 19.001	8 bytes	C W
This Group Object is used to receive via the bus (ABB i-bus® KNX) the weekday, date and time. The telegram also contains information about the validity of the individual values. Telegram value: <ul style="list-style-type: none"> • Coded 8-byte value 				
Note If this Group Object is read, it indicates the last value received. The value may vary from the current device time.				
Prerequisites for visibility <ul style="list-style-type: none"> • Parameter window Device settings \ Parameter Enable Time Group Objects for setting of device time \ Option Date/Time (DPT 19.001) 				
In operation	Central: General	DPT 1.002	1 bit	C R T
This Group Object cyclically sends an In operation telegram on the bus (ABB i-bus® KNX). The sending cycle is set in parameter Sending cycle . The telegram value depends on the setting in the parameter Enable Group Object "In operation" . Telegram value: <ul style="list-style-type: none"> • 1 = Device in operation • 0 = Device in operation 				
Note Readiness can be monitored by another KNX device using this Group Object. If a telegram is not received, the sending device could be faulty or the bus cable to the transmitting device could be interrupted.				
Prerequisites for visibility <ul style="list-style-type: none"> • Parameter window Device settings \ Parameter Enable Group Object "In operation" \ Option <i>Yes, send value 0 cyclically</i> / <i>Yes, send value 1 cyclically</i> 				
Slat adjustment / Stop Up/Down	Central: Shutter	DPT 1.007	1 bit	C W
This Group Object can be used to activate several outputs of the device under central control. It can be defined individually in the parameter Output reacts to central shutter Group Objects for each output whether the output reacts to this Group Object. This Group Object is used to receive, via the bus (ABB i-bus® KNX), the command to stop a movement or to change the slat position. The reaction if a telegram is received is dependent on the setting in the parameter Operating mode : <ul style="list-style-type: none"> • <i>Blind/Shutter control without slat adjustment</i>: If a telegram is received, the movement is stopped. • <i>Blind/Shutter control with slat adjustment</i>: If a telegram is received, the movement is stopped and the slat position can be changed. Telegram value: <ul style="list-style-type: none"> • 1 = Stop / close slats • 0 = Stop / open slats 				
Note With the functions <i>Weather alarms</i> , <i>Block</i> , <i>Forced operation</i> or <i>Automatic sun protection</i> , a telegram does not necessarily result in a change to the Blind/Shutter or slat position. Each relay can perform only a limited number of switching operations per minute. Frequent switching can cause a switching delay. More information → Technical data .				
Prerequisites for visibility <ul style="list-style-type: none"> • Parameter window Device settings \ Parameter Enable central Group Objects "Shutter" \ Option <i>Yes</i> 				
Receive load shedding stage	Central: Load shedding	DPT 236.001	1 byte	C W
This Group Object is used to receive, via the bus (ABB i-bus® KNX), the current load shedding stage. The Group Object applies to the entire device. The load shedding can be set individually for each output. More information: → Function Load shedding, Page 95 . Telegram value: <ul style="list-style-type: none"> • → Coding, Group Object "Receive load shedding stage", Page 290 				
Prerequisites for visibility <ul style="list-style-type: none"> • Parameter window Device settings \ Parameter Enable central Group Object "Receive load shedding stage" \ Option <i>Yes</i> 				

Function	Group Object name	Data point type	Length	Flags
Move to position height	Central: Shutter	DPT 5.001	1 byte	C W

This Group Object can be used to activate several outputs of the device under central control. It can be defined individually in the parameter [Output reacts to central shutter Group Objects](#) for each output whether the output reacts to this Group Object.

This Group Object is used to receive, via the bus (ABB i-bus® KNX), the command for moving the Blind/Shutter to a defined position.

After reaching the target position, the slat position is the same as before the movement. If a telegram is received on the Group Object [Move to position slat](#) during the movement, after the target position is reached the slats are set according to the value received.

Telegram value:

- 0 % = Upper end position
- 1 ... 99 % = Intermediate position
- 100 % = Lower end position



Note

If the slat position was set manually using one of the following Group Objects, this setting will be discarded after the Blind/Shutter is moved.

- [Slat adjustment / Stop Up/Down](#)
- [Slat adjustment / Stop Up/Down](#) (Central)



Note

With the functions *Weather alarms, Block, Forced operation* or *Automatic sun protection*, a telegram does not necessarily result in a change to the Blind/Shutter position.

Each relay can perform only a limited number of switching operations per minute. Frequent switching can cause a switching delay. More information → Technical data.

Prerequisites for visibility

- Parameter window [Device settings](#) \ Parameter [Enable central Group Objects "Shutter"](#) \ Option Yes

Function	Group Object name	Data point type	Length	Flags
Move to position slat	Central: Shutter	DPT 5.001	1 byte	C W

This Group Object can be used to activate several outputs of the device under central control. It can be defined individually in the parameter [Output reacts to central shutter Group Objects](#) for each output whether the output reacts to this Group Object.

This Group Object is used to receive, via the bus (ABB i-bus® KNX), the command to adjust the slats to a specified position.

The slats are positioned after the movement is ended.

Telegram value:

- 0 % = Fully open
- 1 ... 99 % = Intermediate position
- 100 % = Fully closed



Note

With the functions *Weather alarms, Block, Forced operation* or *Automatic sun protection*, a telegram does not necessarily result in a change to the slat position.

Each relay can perform only a limited number of switching operations per minute. Frequent switching can cause a switching delay. More information → Technical data.

Prerequisites for visibility

- Parameter window [Device settings](#) \ Parameter [Enable central Group Objects "Shutter"](#) \ Option Yes

Function	Group Object name	Data point type	Length	Flags
Switch	Central: Switch	DPT 1.001	1 bit	C W

This Group Object can be used to switch several outputs of the device under central control. In the parameter [Switch output reacts to central Switch Group Object](#), it can be defined individually for each output whether the output reacts to this Group Object.

The switching behavior of the outputs is dependent on the settings in the related parameters [Reaction of output](#).

NO contact telegram value:

- 1 = Close relay contact
- 0 = Open relay contact

NC contact telegram value:

- 1 = Open relay contact
- 0 = Close relay contact



Note

Due to the priorities, a switching command does not necessarily change the position of the relay contact.

Each relay can perform only a limited number of switching operations per minute. Frequent switching can cause a switching delay. More information → Technical data.

Prerequisites for visibility

- Parameter window [Device settings](#) \ Parameter [Enable central Group Object "Switch"](#) \ Option Yes

Function	Group Object name	Data point type	Length	Flags
Request status values	Central: General	DPT 1.017	1 bit	C W

If a telegram is received on this Group Object, the values of the status Group Objects are sent on the bus (ABB i-bus® KNX).

Telegram value:

- 1 = Send status values
- 0 = Send status values



Note

The values of the status Group Objects are sent only if sending on request is set in the related parameters.

Prerequisites for visibility

- Parameter window [Device settings](#) \ Parameter [Enable Group Object "Request status values"](#) \ Option Yes

Function	Group Object name	Data point type	Length	Flags
Scene 1 ... 64	Central: Scene	DPT 18.001	1 byte	C W

This Group Object can be used to activate several outputs of the device under central control. This Group Object is used to receive, via the bus (ABB i-bus® KNX), a Scene telegram. The Scene telegram includes the Scene number and information about whether the Scene is recalled or saved. The position of the relay contact is saved for the Switch Actuator. The positions of the Blind/Shutter and the slats are saved for the Shutter Actuator. A Scene number is assigned in the parameter window [Scene assignments \[Shutter Actuator\]](#) or [Scene assignments \[Switch Actuator\]](#). If the corresponding Scene number is parametrized for an output, the Scene is recalled or saved, depending on the telegram value.

- Telegram value:
- 0 ... 63 = Recall Scene x (x = 1 ... 64)
 - 128 ... 191 = Save Scene x (x = 1 ... 64)

For more information, see:
 → [Function Scenes, Page 102](#)
 → [Function diagram Shutter Actuator, Page 86](#)
 → [Function diagram Switch Actuator, Page 87](#)
 → [Table of values, Group Object "Scene 1 ... 64", Page 299](#)

Note
 A telegram does not necessarily result in a change to the position of the Blind/Shutter or the position of the relay contact due to the priorities.

Prerequisites for visibility
 • Parameter window [Device settings](#) \ Parameter [Enable central Group Object "Scene 1 ... 64"](#) \ Option Yes

Set time	Central: Date/Time	DPT 10.001	3 bytes	C W
----------	--------------------	------------	---------	-----

This Group Object is used to receive via the bus (ABB i-bus® KNX) the weekday and time.

- Telegram value:
- DD:hh:mm:ss

Note
 If this Group Object is read, it indicates the last value received. The value may vary from the current device time.

Prerequisites for visibility
 • Parameter window [Device settings](#) \ Parameter [Enable Time Group Objects for setting of device time](#) \ Option Date (DPT 11.001)/time (10.001)

8.3 Group Objects "Device"

Function	Group Object name	Data point type	Length	Flags
Ending manual operation	Manual operation: Manual operation	DPT 1.003	1 bit	C W

This Group Object is used to receive, via the bus (ABB i-bus® KNX), the command to end manual operation.

- Telegram value:
- 1 = End manual operation
 - 0 = End manual operation

Prerequisites for visibility
 • Parameter window [Manual operation](#) \ Parameter [Enable manual operation](#) \ Option Yes

Status Manual operation	Manual operation: Manual operation	DPT 1.011	1 bit	C R T
-------------------------	------------------------------------	-----------	-------	-------

This Group Object sends the status of the *Manual operation* mode on the bus (ABB i-bus® KNX).

- Telegram value:
- 1 = Manual operation active
 - 0 = Manual operation inactive

Prerequisites for visibility
 • Parameter window [Manual operation](#) \ Parameter [Enable manual operation](#) \ Option Yes

Enable/Block manual operation	Manual operation: Manual operation	DPT 1.003	1 bit	C W
-------------------------------	------------------------------------	-----------	-------	-----

The *Manual operation* mode is enabled/blocked using this Group Object. If *Manual operation* mode is active, it will be ended and blocked with telegram value 0.

- Telegram value:
- 1 = Enable manual operation
 - 0 = End manual operation and block

Prerequisites for visibility
 • Parameter window [Manual operation](#) \ Parameter [Enable manual operation](#) \ Option Yes

8.4 Group Objects "Safety"

Function	Group Object name	Data point type	Length	Flags
Safety priority x	Safety: Switch	DPT 1.005	1 bit	C W T U
<p>These Group Objects are used to receive, via the bus (ABB i-bus® KNX), a safety priority. An active safety priority overrides the operation of the device → Switch Actuator safety functions, Page 91. Telegram value:</p> <ul style="list-style-type: none"> • 1 = Alarm • 0 = No alarm 				
<p>Note It is necessary to select in the parameter Read safety Group Objects after bus voltage recovery and download the option <i>Yes</i> to update automatically the Group Objects.</p>				
<p>Note To update the safety Group Objects after bus voltage recovery or download, the read flags must be set for the corresponding Group Objects of the sending device.</p>				
<p>Prerequisites for visibility</p> <ul style="list-style-type: none"> • Parameter window Safety/Weather alarms \ Parameter Enable Group Object "Safety priority x" \ Option <i>Yes</i> 				
Wind alarm x	Safety: Shutter	DPT 1.005	1 bit	C W T U
<p>These Group Objects are used to receive, via the bus (ABB i-bus® KNX) a wind alarm. An active weather alarm overrides the operation of the device → Safety functions of Shutter Actuator, Page 88. Telegram value:</p> <ul style="list-style-type: none"> • 1 = Alarm • 0 = No alarm 				
<p>Note It is necessary to select in the parameter Read safety Group Objects after bus voltage recovery and download the option <i>Yes</i> to update automatically the Group Object.</p>				
<p>Note To update the safety Group Objects after bus voltage recovery or download, the read flags must be set for the corresponding Group Objects of the sending device.</p>				
<p>Prerequisites for visibility</p> <ul style="list-style-type: none"> • Parameter window Safety/Weather alarms \ Parameter Enable Group Object "Wind alarm x" \ Option <i>Yes</i> 				
Rain alarm	Safety: Shutter	DPT 1.005	1 bit	C W T U
<p>This Group Object is used to receive, via the bus (ABB i-bus® KNX), a rain alarm. An active weather alarm overrides the operation of the device → Safety functions of Shutter Actuator, Page 88. Telegram value:</p> <ul style="list-style-type: none"> • 1 = Alarm • 0 = No alarm 				
<p>Note It is necessary to select in the parameter Read safety Group Objects after bus voltage recovery and download the option <i>Yes</i> to update automatically the Group Object.</p>				
<p>Note To update the safety Group Objects after bus voltage recovery or download, the read flags must be set for the corresponding Group Objects of the sending device.</p>				
<p>Prerequisites for visibility</p> <ul style="list-style-type: none"> • Parameter window Safety/Weather alarms \ Parameter Enable Group Object "Rain alarm" \ Option <i>Yes</i> 				
Frost alarm	Safety: Shutter	DPT 1.005	1 bit	C W T U
<p>This Group Object is used to receive, via the bus (ABB i-bus® KNX), a frost alarm. An active weather alarm overrides the operation of the device → Safety functions of Shutter Actuator, Page 88. Telegram value:</p> <ul style="list-style-type: none"> • 1 = Alarm • 0 = No alarm 				
<p>Note It is necessary to select in the parameter Read safety Group Objects after bus voltage recovery and download the option <i>Yes</i> to update automatically the Group Object.</p>				
<p>Note To update the safety Group Objects after bus voltage recovery or download, the read flags must be set for the corresponding Group Objects of the sending device.</p>				
<p>Prerequisites for visibility</p> <ul style="list-style-type: none"> • Parameter window Safety/Weather alarms \ Parameter Enable Group Object "Frost alarm" \ Option <i>Yes</i> 				

8.5 Group Objects Logic/Threshold X

Function	Group Object name	Data point type	Length	Flags
Change upper threshold	Logic/Threshold X: Threshold	DPT 13.010	4 bytes	C W
<p>This Group Object is used to receive, via the bus (ABB i-bus® KNX), a new value for the upper threshold. The data point type for the Group Object depends on the option selected in the parameter Data point type of Group Object "Threshold input". Telegram value:</p> <ul style="list-style-type: none"> 0 ... 2147483647 Wh <p>Prerequisites for visibility</p> <ul style="list-style-type: none"> Parameter window Configuration \ Parameter Enable Logic/Threshold x-y \ Option Yes Parameter window Logic/Threshold \ Parameter window Logic/Threshold x <ul style="list-style-type: none"> Parameter Function of the logic gate \ Option Threshold Parameter Data point type of Group Object "Threshold input" \ Option Wh (DPT 13.010) Parameter Change thresholds via Group Objects \ Option Yes 				
Change upper threshold	Logic/Threshold X: Threshold	DPT 13.013	4 bytes	C W
<p>This Group Object is used to receive, via the bus (ABB i-bus® KNX), a new value for the upper threshold. The data point type for the Group Object depends on the option selected in the parameter Data point type of Group Object "Threshold input". Telegram value:</p> <ul style="list-style-type: none"> 0 ... 2147483647 kWh <p>Prerequisites for visibility</p> <ul style="list-style-type: none"> Parameter window Configuration \ Parameter Enable Logic/Threshold x-y \ Option Yes Parameter window Logic/Threshold \ Parameter window Logic/Threshold x <ul style="list-style-type: none"> Parameter Function of the logic gate \ Option Threshold Parameter Data point type of Group Object "Threshold input" \ Option kWh (DPT 13.013) Parameter Change thresholds via Group Objects \ Option Yes 				
Change upper threshold	Logic/Threshold X: Threshold	DPT 14.019	4 bytes	C W
<p>This Group Object is used to receive, via the bus (ABB i-bus® KNX), a new value for the upper threshold. The data point type for the Group Object depends on the option selected in the parameter Data point type of Group Object "Threshold input". Telegram value:</p> <ul style="list-style-type: none"> 0 ... 24 A <p>Prerequisites for visibility</p> <ul style="list-style-type: none"> Parameter window Configuration \ Parameter Enable Logic/Threshold x-y \ Option Yes Parameter window Logic/Threshold \ Parameter window Logic/Threshold x <ul style="list-style-type: none"> Parameter Function of the logic gate \ Option Threshold Parameter Data point type of Group Object "Threshold input" \ Option A (DPT 14.019) Parameter Change thresholds via Group Objects \ Option Yes 				
Change upper threshold	Logic/Threshold X: Threshold	DPT 14.056	4 bytes	C W
<p>This Group Object is used to receive, via the bus (ABB i-bus® KNX), a new value for the upper threshold. The data point type for the Group Object depends on the option selected in the parameter Data point type of Group Object "Threshold input". Telegram value:</p> <ul style="list-style-type: none"> 0 ... 10000 W <p>Prerequisites for visibility</p> <ul style="list-style-type: none"> Parameter window Configuration \ Parameter Enable Logic/Threshold x-y \ Option Yes Parameter window Logic/Threshold \ Parameter window Logic/Threshold x <ul style="list-style-type: none"> Parameter Function of the logic gate \ Option Threshold Parameter Data point type of Group Object "Threshold input" \ Option W (DPT 14.056) Parameter Change thresholds via Group Objects \ Option Yes 				
Change upper threshold	Logic/Threshold X: Threshold	DPT 5.001	1 byte	C W
<p>This Group Object is used to receive, via the bus (ABB i-bus® KNX), a new value for the upper threshold. The data point type for the Group Object depends on the option selected in the parameter Data point type of Group Object "Threshold input". Telegram value:</p> <ul style="list-style-type: none"> 0 ... 100 % <p>Prerequisites for visibility</p> <ul style="list-style-type: none"> Parameter window Configuration \ Parameter Enable Logic/Threshold x-y \ Option Yes Parameter window Logic/Threshold \ Parameter window Logic/Threshold x <ul style="list-style-type: none"> Parameter Function of the logic gate \ Option Threshold Parameter Data point type of Group Object "Threshold input" \ Option Percent (DPT 5.001) Parameter Change thresholds via Group Objects \ Option Yes 				
Change upper threshold	Logic/Threshold X: Threshold	DPT 5.010	1 byte	C W
<p>This Group Object is used to receive, via the bus (ABB i-bus® KNX), a new value for the upper threshold. The data point type for the Group Object depends on the option selected in the parameter Data point type of Group Object "Threshold input". Telegram value:</p> <ul style="list-style-type: none"> 0 ... 255 <p>Prerequisites for visibility</p> <ul style="list-style-type: none"> Parameter window Configuration \ Parameter Enable Logic/Threshold x-y \ Option Yes Parameter window Logic/Threshold \ Parameter window Logic/Threshold x <ul style="list-style-type: none"> Parameter Function of the logic gate \ Option Threshold Parameter Data point type of Group Object "Threshold input" \ Option Meter pulses (DPT 5.010) Parameter Change thresholds via Group Objects \ Option Yes 				

Function	Group Object name	Data point type	Length	Flags
Change upper threshold	Logic/Threshold X: Threshold	DPT 7.001	2 bytes	C W
<p>This Group Object is used to receive, via the bus (ABB i-bus® KNX), a new value for the upper threshold. The data point type for the Group Object depends on the option selected in the parameter Data point type of Group Object "Threshold input". Telegram value:</p> <ul style="list-style-type: none"> 0 ... 65535 <p>Prerequisites for visibility</p> <ul style="list-style-type: none"> Parameter window Configuration \ Parameter Enable Logic/Threshold x-y \ Option Yes Parameter window Logic/Threshold \ Parameter window Logic/Threshold x <ul style="list-style-type: none"> Parameter Function of the logic gate \ Option Threshold Parameter Data point type of Group Object "Threshold input" \ Option Meter pulses (DPT 7.001) Parameter Change thresholds via Group Objects \ Option Yes 				
Change upper threshold	Logic/Threshold X: Threshold	DPT 9.001	2 bytes	C W
<p>This Group Object is used to receive, via the bus (ABB i-bus® KNX), a new value for the upper threshold. The data point type for the Group Object depends on the option selected in the parameter Data point type of Group Object "Threshold input". Telegram value:</p> <ul style="list-style-type: none"> -273 ... 670760 °C <p>Prerequisites for visibility</p> <ul style="list-style-type: none"> Parameter window Configuration \ Parameter Enable Logic/Threshold x-y \ Option Yes Parameter window Logic/Threshold \ Parameter window Logic/Threshold x <ul style="list-style-type: none"> Parameter Function of the logic gate \ Option Threshold Parameter Data point type of Group Object "Threshold input" \ Option Temperature (DPT 9.001) Parameter Change thresholds via Group Objects \ Option Yes 				
Change upper threshold	Logic/Threshold X: Threshold	DPT 9.004	2 bytes	C W
<p>This Group Object is used to receive, via the bus (ABB i-bus® KNX), a new value for the upper threshold. The data point type for the Group Object depends on the option selected in the parameter Data point type of Group Object "Threshold input". Telegram value:</p> <ul style="list-style-type: none"> 0 ... 670760 lux <p>Prerequisites for visibility</p> <ul style="list-style-type: none"> Parameter window Configuration \ Parameter Enable Logic/Threshold x-y \ Option Yes Parameter window Logic/Threshold \ Parameter window Logic/Threshold x <ul style="list-style-type: none"> Parameter Function of the logic gate \ Option Threshold Parameter Data point type of Group Object "Threshold input" \ Option Lux (DPT 9.004) Parameter Change thresholds via Group Objects \ Option Yes 				
Change upper threshold	Logic/Threshold X: Threshold	DPT 9.021	2 bytes	C W
<p>This Group Object is used to receive, via the bus (ABB i-bus® KNX), a new value for the upper threshold. The data point type for the Group Object depends on the option selected in the parameter Data point type of Group Object "Threshold input". Telegram value:</p> <ul style="list-style-type: none"> 0 ... 240000 mA <p>Prerequisites for visibility</p> <ul style="list-style-type: none"> Parameter window Configuration \ Parameter Enable Logic/Threshold x-y \ Option Yes Parameter window Logic/Threshold \ Parameter window Logic/Threshold x <ul style="list-style-type: none"> Parameter Function of the logic gate \ Option Threshold Parameter Data point type of Group Object "Threshold input" \ Option mA (DPT 9.021) Parameter Change thresholds via Group Objects \ Option Yes 				
Change upper threshold	Logic/Threshold X: Threshold	DPT 9.024	2 bytes	C W
<p>This Group Object is used to receive, via the bus (ABB i-bus® KNX), a new value for the upper threshold. The data point type for the Group Object depends on the option selected in the parameter Data point type of Group Object "Threshold input". Telegram value:</p> <ul style="list-style-type: none"> 0 ... 10 kW <p>Prerequisites for visibility</p> <ul style="list-style-type: none"> Parameter window Configuration \ Parameter Enable Logic/Threshold x-y \ Option Yes Parameter window Logic/Threshold \ Parameter window Logic/Threshold x <ul style="list-style-type: none"> Parameter Function of the logic gate \ Option Threshold Parameter Data point type of Group Object "Threshold input" \ Option kW (DPT 9.024) Parameter Change thresholds via Group Objects \ Option Yes 				
Threshold input	Logic/Threshold X: Threshold	DPT 13.010	4 bytes	C W T U
<p>This Group Object is used to receive, via the bus (ABB i-bus® KNX), the input value for the function Threshold. The data point type for the Group Object depends on the option selected in the parameter Data point type of Group Object "Threshold input". Telegram value:</p> <ul style="list-style-type: none"> 0 ... 2147483647 Wh <p>Note It is necessary to select in the parameter Read input Group Objects after bus voltage recovery and download the option Yes to update automatically the Group Object.</p> <p>Note To update the input Group Objects after bus voltage recovery or download, the read flags must be set for the corresponding Group Objects of the sending device.</p> <p>Prerequisites for visibility</p> <ul style="list-style-type: none"> Parameter window Configuration \ Parameter Enable Logic/Threshold x-y \ Option Yes Parameter window Logic/Threshold \ Parameter window Logic/Threshold x <ul style="list-style-type: none"> Parameter Function of the logic gate \ Option Threshold Parameter Data point type of Group Object "Threshold input" \ Option Wh (DPT 13.010) 				

Function	Group Object name	Data point type	Length	Flags
Threshold input	Logic/Threshold X: Threshold	DPT 13.013	4 bytes	C W T U
<p>This Group Object is used to receive, via the bus (ABB i-bus® KNX), the input value for the function <i>Threshold</i>. The data point type for the Group Object depends on the option selected in the parameter <i>Data point type of Group Object "Threshold input"</i>. Telegram value:</p> <ul style="list-style-type: none"> 0 ... 2147483647 kWh 				
<p>Note It is necessary to select in the parameter <i>Read input Group Objects after bus voltage recovery and download</i> the option <i>Yes</i> to update automatically the Group Object.</p>				
<p>Note To update the input Group Objects after bus voltage recovery or download, the read flags must be set for the corresponding Group Objects of the sending device.</p>				
<p>Prerequisites for visibility</p> <ul style="list-style-type: none"> Parameter window <i>Configuration</i> \ Parameter <i>Enable Logic/Threshold x-y</i> \ Option <i>Yes</i> Parameter window <i>Logic/Threshold</i> \ Parameter window <i>Logic/Threshold x</i> <ul style="list-style-type: none"> Parameter <i>Function of the logic gate</i> \ Option <i>Threshold</i> Parameter <i>Data point type of Group Object "Threshold input"</i> \ Option <i>kWh (DPT 13.013)</i> 				
Threshold input	Logic/Threshold X: Threshold	DPT 14.019	4 bytes	C W T U
<p>This Group Object is used to receive, via the bus (ABB i-bus® KNX), the input value for the function <i>Threshold</i>. The data point type for the Group Object depends on the option selected in the parameter <i>Data point type of Group Object "Threshold input"</i>. Telegram value:</p> <ul style="list-style-type: none"> 0 ... 24 A 				
<p>Note It is necessary to select in the parameter <i>Read input Group Objects after bus voltage recovery and download</i> the option <i>Yes</i> to update automatically the Group Object.</p>				
<p>Note To update the input Group Objects after bus voltage recovery or download, the read flags must be set for the corresponding Group Objects of the sending device.</p>				
<p>Prerequisites for visibility</p> <ul style="list-style-type: none"> Parameter window <i>Configuration</i> \ Parameter <i>Enable Logic/Threshold x-y</i> \ Option <i>Yes</i> Parameter window <i>Logic/Threshold</i> \ Parameter window <i>Logic/Threshold x</i> <ul style="list-style-type: none"> Parameter <i>Function of the logic gate</i> \ Option <i>Threshold</i> Parameter <i>Data point type of Group Object "Threshold input"</i> \ Option <i>A (DPT 14.019)</i> 				
Threshold input	Logic/Threshold X: Threshold	DPT 14.056	4 bytes	C W T U
<p>This Group Object is used to receive, via the bus (ABB i-bus® KNX), the input value for the function <i>Threshold</i>. The data point type for the Group Object depends on the option selected in the parameter <i>Data point type of Group Object "Threshold input"</i>. Telegram value:</p> <ul style="list-style-type: none"> 0 ... 10000 W 				
<p>Note It is necessary to select in the parameter <i>Read input Group Objects after bus voltage recovery and download</i> the option <i>Yes</i> to update automatically the Group Object.</p>				
<p>Note To update the input Group Objects after bus voltage recovery or download, the read flags must be set for the corresponding Group Objects of the sending device.</p>				
<p>Prerequisites for visibility</p> <ul style="list-style-type: none"> Parameter window <i>Configuration</i> \ Parameter <i>Enable Logic/Threshold x-y</i> \ Option <i>Yes</i> Parameter window <i>Logic/Threshold</i> \ Parameter window <i>Logic/Threshold x</i> <ul style="list-style-type: none"> Parameter <i>Function of the logic gate</i> \ Option <i>Threshold</i> Parameter <i>Data point type of Group Object "Threshold input"</i> \ Option <i>W (DPT 14.056)</i> 				
Threshold input	Logic/Threshold X: Threshold	DPT 5.001	1 byte	C W T U
<p>This Group Object is used to receive, via the bus (ABB i-bus® KNX), the input value for the function <i>Threshold</i>. The data point type for the Group Object depends on the option selected in the parameter <i>Data point type of Group Object "Threshold input"</i>. Telegram value:</p> <ul style="list-style-type: none"> 0 ... 100 % 				
<p>Note It is necessary to select in the parameter <i>Read input Group Objects after bus voltage recovery and download</i> the option <i>Yes</i> to update automatically the Group Object.</p>				
<p>Note To update the input Group Objects after bus voltage recovery or download, the read flags must be set for the corresponding Group Objects of the sending device.</p>				
<p>Prerequisites for visibility</p> <ul style="list-style-type: none"> Parameter window <i>Configuration</i> \ Parameter <i>Enable Logic/Threshold x-y</i> \ Option <i>Yes</i> Parameter window <i>Logic/Threshold</i> \ Parameter window <i>Logic/Threshold x</i> <ul style="list-style-type: none"> Parameter <i>Function of the logic gate</i> \ Option <i>Threshold</i> Parameter <i>Data point type of Group Object "Threshold input"</i> \ Option <i>Percent (DPT 5.001)</i> 				

Function	Group Object name	Data point type	Length	Flags
Threshold input	Logic/Threshold X: Threshold	DPT 5.010	1 byte	C W T U
<p>This Group Object is used to receive, via the bus (ABB i-bus® KNX), the input value for the function <i>Threshold</i>. The data point type for the Group Object depends on the option selected in the parameter <i>Data point type of Group Object "Threshold input"</i>. Telegram value:</p> <ul style="list-style-type: none"> • 0 ... 255 				
<p>Note It is necessary to select in the parameter <i>Read input Group Objects after bus voltage recovery and download</i> the option <i>Yes</i> to update automatically the Group Object.</p>				
<p>Note To update the input Group Objects after bus voltage recovery or download, the read flags must be set for the corresponding Group Objects of the sending device.</p>				
<p>Prerequisites for visibility</p> <ul style="list-style-type: none"> • Parameter window <i>Configuration</i> \ Parameter <i>Enable Logic/Threshold x-y</i> \ Option <i>Yes</i> • Parameter window <i>Logic/Threshold</i> \ Parameter window <i>Logic/Threshold x</i> <ul style="list-style-type: none"> – Parameter <i>Function of the logic gate</i> \ Option <i>Threshold</i> – Parameter <i>Data point type of Group Object "Threshold input"</i> \ Option <i>Meter pulses (DPT 5.010)</i> 				
Threshold input	Logic/Threshold X: Threshold	DPT 7.001	2 bytes	C W T U
<p>This Group Object is used to receive, via the bus (ABB i-bus® KNX), the input value for the function <i>Threshold</i>. The data point type for the Group Object depends on the option selected in the parameter <i>Data point type of Group Object "Threshold input"</i>. Telegram value:</p> <ul style="list-style-type: none"> • 0 ... 65535 				
<p>Note It is necessary to select in the parameter <i>Read input Group Objects after bus voltage recovery and download</i> the option <i>Yes</i> to update automatically the Group Object.</p>				
<p>Note To update the input Group Objects after bus voltage recovery or download, the read flags must be set for the corresponding Group Objects of the sending device.</p>				
<p>Prerequisites for visibility</p> <ul style="list-style-type: none"> • Parameter window <i>Configuration</i> \ Parameter <i>Enable Logic/Threshold x-y</i> \ Option <i>Yes</i> • Parameter window <i>Logic/Threshold</i> \ Parameter window <i>Logic/Threshold x</i> <ul style="list-style-type: none"> – Parameter <i>Function of the logic gate</i> \ Option <i>Threshold</i> – Parameter <i>Data point type of Group Object "Threshold input"</i> \ Option <i>Meter pulses (DPT 7.001)</i> 				
Threshold input	Logic/Threshold X: Threshold	DPT 9.001	2 bytes	C W T U
<p>This Group Object is used to receive, via the bus (ABB i-bus® KNX), the input value for the function <i>Threshold</i>. The data point type for the Group Object depends on the option selected in the parameter <i>Data point type of Group Object "Threshold input"</i>. Telegram value:</p> <ul style="list-style-type: none"> • -273 ... 670760 °C 				
<p>Note It is necessary to select in the parameter <i>Read input Group Objects after bus voltage recovery and download</i> the option <i>Yes</i> to update automatically the Group Object.</p>				
<p>Note To update the input Group Objects after bus voltage recovery or download, the read flags must be set for the corresponding Group Objects of the sending device.</p>				
<p>Prerequisites for visibility</p> <ul style="list-style-type: none"> • Parameter window <i>Configuration</i> \ Parameter <i>Enable Logic/Threshold x-y</i> \ Option <i>Yes</i> • Parameter window <i>Logic/Threshold</i> \ Parameter window <i>Logic/Threshold x</i> <ul style="list-style-type: none"> – Parameter <i>Function of the logic gate</i> \ Option <i>Threshold</i> – Parameter <i>Data point type of Group Object "Threshold input"</i> \ Option <i>Temperature (DPT 9.001)</i> 				
Threshold input	Logic/Threshold X: Threshold	DPT 9.004	2 bytes	C W T U
<p>This Group Object is used to receive, via the bus (ABB i-bus® KNX), the input value for the function <i>Threshold</i>. The data point type for the Group Object depends on the option selected in the parameter <i>Data point type of Group Object "Threshold input"</i>. Telegram value:</p> <ul style="list-style-type: none"> • 0 ... 670760 lux 				
<p>Note It is necessary to select in the parameter <i>Read input Group Objects after bus voltage recovery and download</i> the option <i>Yes</i> to update automatically the Group Object.</p>				
<p>Note To update the input Group Objects after bus voltage recovery or download, the read flags must be set for the corresponding Group Objects of the sending device.</p>				
<p>Prerequisites for visibility</p> <ul style="list-style-type: none"> • Parameter window <i>Configuration</i> \ Parameter <i>Enable Logic/Threshold x-y</i> \ Option <i>Yes</i> • Parameter window <i>Logic/Threshold</i> \ Parameter window <i>Logic/Threshold x</i> <ul style="list-style-type: none"> – Parameter <i>Function of the logic gate</i> \ Option <i>Threshold</i> – Parameter <i>Data point type of Group Object "Threshold input"</i> \ Option <i>Lux (DPT 9.004)</i> 				

Function	Group Object name	Data point type	Length	Flags
Threshold input	Logic/Threshold X: Threshold	DPT 9.021	2 bytes	C W T U
<p>This Group Object is used to receive, via the bus (ABB i-bus® KNX), the input value for the function <i>Threshold</i>. The data point type for the Group Object depends on the option selected in the parameter <i>Data point type of Group Object "Threshold input"</i>. Telegram value:</p> <ul style="list-style-type: none"> 0 ... 240000 mA 				
<p>Note It is necessary to select in the parameter <i>Read input Group Objects after bus voltage recovery and download</i> the option <i>Yes</i> to update automatically the Group Object.</p>				
<p>Note To update the input Group Objects after bus voltage recovery or download, the read flags must be set for the corresponding Group Objects of the sending device.</p>				
<p>Prerequisites for visibility</p> <ul style="list-style-type: none"> Parameter window <i>Configuration</i> \ Parameter <i>Enable Logic/Threshold x-y</i> \ Option <i>Yes</i> Parameter window <i>Logic/Threshold</i> \ Parameter window <i>Logic/Threshold x</i> <ul style="list-style-type: none"> Parameter <i>Function of the logic gate</i> \ Option <i>Threshold</i> Parameter <i>Data point type of Group Object "Threshold input"</i> \ Option <i>mA (DPT 9.021)</i> 				
Threshold input	Logic/Threshold X: Threshold	DPT 9.024	2 bytes	C W T U
<p>This Group Object is used to receive, via the bus (ABB i-bus® KNX), the input value for the function <i>Threshold</i>. The data point type for the Group Object depends on the option selected in the parameter <i>Data point type of Group Object "Threshold input"</i>. Telegram value:</p> <ul style="list-style-type: none"> 0 ... 10 kW 				
<p>Note It is necessary to select in the parameter <i>Read input Group Objects after bus voltage recovery and download</i> the option <i>Yes</i> to update automatically the Group Object.</p>				
<p>Note To update the input Group Objects after bus voltage recovery or download, the read flags must be set for the corresponding Group Objects of the sending device.</p>				
<p>Prerequisites for visibility</p> <ul style="list-style-type: none"> Parameter window <i>Configuration</i> \ Parameter <i>Enable Logic/Threshold x-y</i> \ Option <i>Yes</i> Parameter window <i>Logic/Threshold</i> \ Parameter window <i>Logic/Threshold x</i> <ul style="list-style-type: none"> Parameter <i>Function of the logic gate</i> \ Option <i>Threshold</i> Parameter <i>Data point type of Group Object "Threshold input"</i> \ Option <i>kW (DPT 9.024)</i> 				
Status input value between thresholds	Logic/Threshold X: Threshold	DPT 1.002	1 bit	C R T
<p>This Group Object sends the value 1 on the bus (ABB i-bus® KNX) if the input value for the function <i>Threshold</i> is between the thresholds. More information: → Function Threshold, Page 94. Telegram value:</p> <ul style="list-style-type: none"> 1 = Input value is between the thresholds (logically true) 0 = Input value is not between the thresholds (logically false) 				
<p>Prerequisites for visibility</p> <ul style="list-style-type: none"> Parameter window <i>Configuration</i> \ Parameter <i>Enable Logic/Threshold x-y</i> \ Option <i>Yes</i> Parameter window <i>Logic/Threshold</i> \ Parameter window <i>Logic/Threshold x</i> <ul style="list-style-type: none"> Parameter <i>Function of the logic gate</i> \ Option <i>Threshold</i> Parameter <i>Monitor range between thresholds</i> \ Option <i>Yes</i> Parameter <i>Enable Group Objects "Status Result" and "Status Input value between thresholds"</i> \ Option <i>Yes</i> 				
Status Result [Logic]	Logic/Threshold X: Logic	DPT 1.002	1 bit	C R T
<p>This Group Object sends the result of the function <i>Logic</i> on the bus (ABB i-bus® KNX). More information: → Function Logic, Page 93. Telegram value:</p> <ul style="list-style-type: none"> 1 = Logically true 0 = Logically false 				
<p>Note The result can be inverted → parameter <i>Invert result</i>.</p>				
<p>Prerequisites for visibility</p> <ul style="list-style-type: none"> Parameter window <i>Configuration</i> \ Parameter <i>Enable Logic/Threshold x-y</i> \ Option <i>Yes</i> Parameter window <i>Logic/Threshold</i> \ Parameter window <i>Logic/Threshold x</i> <ul style="list-style-type: none"> Parameter <i>Function of the logic gate</i> \ Option <i>AND / OR / Exclusive OR / GATE / 1 bit Inverter</i> Parameter <i>Enable Group Object "Status Result"</i> \ Option <i>Yes</i> 				
Status Result [Threshold]	Logic/Threshold X: Threshold	DPT 1.002	1 bit	C R T
<p>This Group Object sends the result of the function <i>Threshold</i> on the bus (ABB i-bus® KNX). More information: → Function Threshold, Page 94. Telegram value:</p> <ul style="list-style-type: none"> Dependent on the settings in the following parameters: <ul style="list-style-type: none"> <i>Result if upper threshold is exceeded</i> <i>Result if lower threshold is dropped below</i> 				
<p>Prerequisites for visibility</p> <ul style="list-style-type: none"> Parameter window <i>Configuration</i> \ Parameter <i>Enable Logic/Threshold x-y</i> \ Option <i>Yes</i> Parameter window <i>Logic/Threshold</i> \ Parameter window <i>Logic/Threshold x</i> <ul style="list-style-type: none"> Parameter <i>Function of the logic gate</i> \ Option <i>Threshold</i> Parameter <i>Enable Group Objects "Status Result" and "Status Input value between thresholds"</i> \ Option <i>Yes</i> 				

Function	Group Object name	Data point type	Length	Flags
Change lower threshold	Logic/Threshold X: Threshold	DPT 13.010	4 bytes	C W
This Group Object is used to receive, via the bus (ABB i-bus® KNX), a new value for the lower threshold. The data point type for the Group Object depends on the option selected in the parameter Data point type of Group Object "Threshold input" . Telegram value: <ul style="list-style-type: none"> • 0 ... 2147483647 Wh Prerequisites for visibility <ul style="list-style-type: none"> • Parameter window Configuration \ Parameter Enable Logic/Threshold x-y \ Option Yes • Parameter window Logic/Threshold \ Parameter window Logic/Threshold x <ul style="list-style-type: none"> – Parameter Function of the logic gate \ Option Threshold – Parameter Data point type of Group Object "Threshold input" \ Option Wh (DPT 13.010) – Parameter Change thresholds via Group Objects \ Option Yes 				
Change lower threshold	Logic/Threshold X: Threshold	DPT 13.013	4 bytes	C W
This Group Object is used to receive, via the bus (ABB i-bus® KNX), a new value for the lower threshold. The data point type for the Group Object depends on the option selected in the parameter Data point type of Group Object "Threshold input" . Telegram value: <ul style="list-style-type: none"> • 0 ... 2147483647 kWh Prerequisites for visibility <ul style="list-style-type: none"> • Parameter window Configuration \ Parameter Enable Logic/Threshold x-y \ Option Yes • Parameter window Logic/Threshold \ Parameter window Logic/Threshold x <ul style="list-style-type: none"> – Parameter Function of the logic gate \ Option Threshold – Parameter Data point type of Group Object "Threshold input" \ Option kWh (DPT 13.013) – Parameter Change thresholds via Group Objects \ Option Yes 				
Change lower threshold	Logic/Threshold X: Threshold	DPT 14.019	4 bytes	C W
This Group Object is used to receive, via the bus (ABB i-bus® KNX), a new value for the lower threshold. The data point type for the Group Object depends on the option selected in the parameter Data point type of Group Object "Threshold input" . Telegram value: <ul style="list-style-type: none"> • 0 ... 24 A Prerequisites for visibility <ul style="list-style-type: none"> • Parameter window Configuration \ Parameter Enable Logic/Threshold x-y \ Option Yes • Parameter window Logic/Threshold \ Parameter window Logic/Threshold x <ul style="list-style-type: none"> – Parameter Function of the logic gate \ Option Threshold – Parameter Data point type of Group Object "Threshold input" \ Option A (DPT 14.019) – Parameter Change thresholds via Group Objects \ Option Yes 				
Change lower threshold	Logic/Threshold X: Threshold	DPT 14.056	4 bytes	C W
This Group Object is used to receive, via the bus (ABB i-bus® KNX), a new value for the lower threshold. The data point type for the Group Object depends on the option selected in the parameter Data point type of Group Object "Threshold input" . Telegram value: <ul style="list-style-type: none"> • 0 ... 10000 W Prerequisites for visibility <ul style="list-style-type: none"> • Parameter window Configuration \ Parameter Enable Logic/Threshold x-y \ Option Yes • Parameter window Logic/Threshold \ Parameter window Logic/Threshold x <ul style="list-style-type: none"> – Parameter Function of the logic gate \ Option Threshold – Parameter Data point type of Group Object "Threshold input" \ Option W (DPT 14.056) – Parameter Change thresholds via Group Objects \ Option Yes 				
Change lower threshold	Logic/Threshold X: Threshold	DPT 5.001	1 byte	C W
This Group Object is used to receive, via the bus (ABB i-bus® KNX), a new value for the lower threshold. The data point type for the Group Object depends on the option selected in the parameter Data point type of Group Object "Threshold input" . Telegram value: <ul style="list-style-type: none"> • 0 ... 100 % Prerequisites for visibility <ul style="list-style-type: none"> • Parameter window Configuration \ Parameter Enable Logic/Threshold x-y \ Option Yes • Parameter window Logic/Threshold \ Parameter window Logic/Threshold x <ul style="list-style-type: none"> – Parameter Function of the logic gate \ Option Threshold – Parameter Data point type of Group Object "Threshold input" \ Option Percent (DPT 5.001) – Parameter Change thresholds via Group Objects \ Option Yes 				
Change lower threshold	Logic/Threshold X: Threshold	DPT 5.010	1 byte	C W
This Group Object is used to receive, via the bus (ABB i-bus® KNX), a new value for the lower threshold. The data point type for the Group Object depends on the option selected in the parameter Data point type of Group Object "Threshold input" . Telegram value: <ul style="list-style-type: none"> • 0 ... 255 Prerequisites for visibility <ul style="list-style-type: none"> • Parameter window Configuration \ Parameter Enable Logic/Threshold x-y \ Option Yes • Parameter window Logic/Threshold \ Parameter window Logic/Threshold x <ul style="list-style-type: none"> – Parameter Function of the logic gate \ Option Threshold – Parameter Data point type of Group Object "Threshold input" \ Option Meter pulses (DPT 5.010) – Parameter Change thresholds via Group Objects \ Option Yes 				

Function	Group Object name	Data point type	Length	Flags	
Change lower threshold	Logic/Threshold X: Threshold	DPT 7.001	2 bytes	C	W
This Group Object is used to receive, via the bus (ABB i-bus® KNX), a new value for the lower threshold. The data point type for the Group Object depends on the option selected in the parameter Data point type of Group Object "Threshold input" . Telegram value: <ul style="list-style-type: none"> • 0 ... 65535 Prerequisites for visibility <ul style="list-style-type: none"> • Parameter window Configuration \ Parameter Enable Logic/Threshold x-y \ Option Yes • Parameter window Logic/Threshold \ Parameter window Logic/Threshold x <ul style="list-style-type: none"> – Parameter Function of the logic gate \ Option Threshold – Parameter Data point type of Group Object "Threshold input" \ Option Meter pulses (DPT 7.001) – Parameter Change thresholds via Group Objects \ Option Yes 					
Change lower threshold	Logic/Threshold X: Threshold	DPT 9.001	2 bytes	C	W
This Group Object is used to receive, via the bus (ABB i-bus® KNX), a new value for the lower threshold. The data point type for the Group Object depends on the option selected in the parameter Data point type of Group Object "Threshold input" . Telegram value: <ul style="list-style-type: none"> • -273 ... 670760 °C Prerequisites for visibility <ul style="list-style-type: none"> • Parameter window Configuration \ Parameter Enable Logic/Threshold x-y \ Option Yes • Parameter window Logic/Threshold \ Parameter window Logic/Threshold x <ul style="list-style-type: none"> – Parameter Function of the logic gate \ Option Threshold – Parameter Data point type of Group Object "Threshold input" \ Option Temperature (DPT 9.001) – Parameter Change thresholds via Group Objects \ Option Yes 					
Change lower threshold	Logic/Threshold X: Threshold	DPT 9.004	2 bytes	C	W
This Group Object is used to receive, via the bus (ABB i-bus® KNX), a new value for the lower threshold. The data point type for the Group Object depends on the option selected in the parameter Data point type of Group Object "Threshold input" . Telegram value: <ul style="list-style-type: none"> • 0 ... 670760 lux Prerequisites for visibility <ul style="list-style-type: none"> • Parameter window Configuration \ Parameter Enable Logic/Threshold x-y \ Option Yes • Parameter window Logic/Threshold \ Parameter window Logic/Threshold x <ul style="list-style-type: none"> – Parameter Function of the logic gate \ Option Threshold – Parameter Data point type of Group Object "Threshold input" \ Option Lux (DPT 9.004) – Parameter Change thresholds via Group Objects \ Option Yes 					
Change lower threshold	Logic/Threshold X: Threshold	DPT 9.021	2 bytes	C	W
This Group Object is used to receive, via the bus (ABB i-bus® KNX), a new value for the lower threshold. The data point type for the Group Object depends on the option selected in the parameter Data point type of Group Object "Threshold input" . Telegram value: <ul style="list-style-type: none"> • 0 ... 240000 mA Prerequisites for visibility <ul style="list-style-type: none"> • Parameter window Configuration \ Parameter Enable Logic/Threshold x-y \ Option Yes • Parameter window Logic/Threshold \ Parameter window Logic/Threshold x <ul style="list-style-type: none"> – Parameter Function of the logic gate \ Option Threshold – Parameter Data point type of Group Object "Threshold input" \ Option mA (DPT 9.021) – Parameter Change thresholds via Group Objects \ Option Yes 					
Change lower threshold	Logic/Threshold X: Threshold	DPT 9.024	2 bytes	C	W
This Group Object is used to receive, via the bus (ABB i-bus® KNX), a new value for the lower threshold. The data point type for the Group Object depends on the option selected in the parameter Data point type of Group Object "Threshold input" . Telegram value: <ul style="list-style-type: none"> • 0 ... 10 kW Prerequisites for visibility <ul style="list-style-type: none"> • Parameter window Configuration \ Parameter Enable Logic/Threshold x-y \ Option Yes • Parameter window Logic/Threshold \ Parameter window Logic/Threshold x <ul style="list-style-type: none"> – Parameter Function of the logic gate \ Option Threshold – Parameter Data point type of Group Object "Threshold input" \ Option kW (DPT 9.024) – Parameter Change thresholds via Group Objects \ Option Yes 					
Connection A	Logic/Threshold X: Logic	DPT 1.002	1 bit	C	W
This Group Object is used to receive, via the bus (ABB i-bus® KNX), an input value for the function Logic . More information: → Function Logic, Page 93 . Telegram value: <ul style="list-style-type: none"> • 1 = Logically true • 0 = Logically false 					
<p>Note</p> <p>It is necessary to select in the parameter Read input Group Objects after bus voltage recovery and download the option Yes to update automatically the Group Object.</p>					
<p>Note</p> <p>To update the input Group Objects after bus voltage recovery or download, the read flags must be set for the corresponding Group Objects of the sending device.</p>					
Prerequisites for visibility <ul style="list-style-type: none"> • Parameter window Configuration \ Parameter Enable Logic/Threshold x-y \ Option Yes • Parameter window Logic/Threshold \ Parameter window Logic/Threshold x \ Parameter Function of the logic gate \ Option AND / OR / Exclusive OR / GATE / 1 bit Inverter 					

Function	Group Object name	Data point type	Length	Flags
Connection B	Logic/Threshold X: Logic	DPT 1.002	1 bit	C W
<p>This Group Object is used to receive, via the bus (ABB i-bus® KNX), an input value for the function <i>Logic</i>. More information: → Function Logic, Page 93. Telegram value:</p> <ul style="list-style-type: none"> • 1 = Logically true • 0 = Logically false <p>Note It is necessary to select in the parameter <i>Read input Group Objects after bus voltage recovery and download</i> the option <i>Yes</i> to update automatically the Group Object.</p> <p>Note To update the input Group Objects after bus voltage recovery or download, the read flags must be set for the corresponding Group Objects of the sending device.</p> <p>Prerequisites for visibility</p> <ul style="list-style-type: none"> • Parameter window Configuration \ Parameter Enable Logic/Threshold x-y \ Option <i>Yes</i> • Parameter window Logic/Threshold \ Parameter window Logic/Threshold x \ Parameter Function of the logic gate \ Option <i>AND / OR / Exclusive OR / GATE</i> 				

8.6 Group Objects Channel X + Y: Shutter

Function	Group Object name	Data point type	Length	Flags
Activate/Deactivate limitation	Channel X: Shutter	DPT 1.0003	1 bit	C W
<p>This Group Object is used to Activate/Deactivate the limitation of the travel range via the bus (ABB i-bus® KNX). More information: → Travel range limit, Page 288. Telegram value:</p> <ul style="list-style-type: none"> • 1 = Activate limitation • 0 = Deactivate limitation <p>Prerequisites for visibility</p> <ul style="list-style-type: none"> • Parameter window Configuration <ul style="list-style-type: none"> – Parameter Enable output X + Y \ Option <i>Yes</i> – Parameter Application \ Option <i>Shutter Actuator</i> • Parameter window Shutter Actuator X+Y \ Parameter window Shutter Actuator functions \ Parameter Operating mode \ Option <i>Blind/Shutter control with slat adjustment</i> • Parameter window Shutter Actuator X+Y \ Parameter window Blind/Shutter <ul style="list-style-type: none"> – Parameter Parameter setting \ Option <i>Individual</i> – Parameter Limit travel range via Group Object \ Option <i>Activate limitation</i> 				
Move Blind/Shutter Up/Down limited	Channel X: Shutter	DPT 1.008	1 bit	C W
<p>This Group Object is used to receive, via the bus (ABB i-bus® KNX), the command for limited movement of the Blind/Shutter. The limitation can be defined in the parameter Limit travel range via Group Object. More information: → Travel range limit, Page 288. Telegram value:</p> <ul style="list-style-type: none"> • 1 = Down limited • 0 = Up limited <p>Note With the functions <i>Weather alarms, Block, Forced operation</i> or <i>Automatic sun protection</i>, a telegram does not necessarily result in a change to the Blind/Shutter position.</p> <p>Prerequisites for visibility</p> <ul style="list-style-type: none"> • Parameter window Configuration <ul style="list-style-type: none"> – Parameter Enable output X + Y \ Option <i>Yes</i> – Parameter Application \ Option <i>Shutter Actuator</i> • Parameter window Shutter Actuator X+Y \ Parameter window Blind/Shutter <ul style="list-style-type: none"> – Parameter Parameter setting \ Option <i>Individual</i> – Parameter Limit travel range via Group Object \ Option <i>Move Blind/Shutter Up/Down limited</i> 				
Move Blind/Shutter Up/Down	Channel X: Shutter	DPT 1.008	1 bit	C W
<p>This Group Object is used to receive, via the bus (ABB i-bus® KNX), the command for moving the Blind/Shutter. If no other movement commands are received, the Blind/Shutter is moved to the Upper/Lower end position. Telegram value:</p> <ul style="list-style-type: none"> • 1 = Down • 0 = Up <p>Note With the functions <i>Weather alarms, Block, Forced operation</i> or <i>Automatic sun protection</i>, a telegram does not necessarily result in a change to the Blind/Shutter position.</p> <p>Prerequisites for visibility</p> <ul style="list-style-type: none"> • Parameter window Configuration <ul style="list-style-type: none"> – Parameter Enable output X + Y \ Option <i>Yes</i> – Parameter Application \ Option <i>Shutter Actuator</i> 				

Function	Group Object name	Data point type	Length	Flags
Block direct operation	Channel X: Shutter	DPT 1.003	1 bit	C W
<p>This Group Object is used to block/unblock, via the bus (ABB i-bus® KNX), direct operation. More information: → Direct operation, Page 102. Telegram value:</p> <ul style="list-style-type: none"> • 1 = Block direct operation • 0 = Unblock direct operation 				
<p>Note Direct operation can be blocked/unblocked if Automatic sun protection is activated.</p>				
<p>Prerequisites for visibility</p> <ul style="list-style-type: none"> • Parameter window Configuration <ul style="list-style-type: none"> – Parameter Enable output X + Y \ Option Yes – Parameter Application \ Option <i>Shutter Actuator</i> • Parameter window Shutter Actuator X+Y \ Parameter window Shutter Actuator functions \ Parameter Enable function Automatic sun protection \ Option Yes • Parameter window Shutter Actuator X+Y \ Parameter window Automatic sun protection <ul style="list-style-type: none"> – Parameter Parameter setting \ Option <i>Individual</i> – Parameter Enable Group Object "Block direct operation" \ Option Yes 				
Slat adjustment / Stop Up/Down	Channel X: Shutter	DPT 1.007	1 bit	C W
<p>This Group Object is used to receive, via the bus (ABB i-bus® KNX), the command to stop a movement or to change the slat position. The reaction if a telegram is received is dependent on the setting in the parameter Operating mode.</p> <ul style="list-style-type: none"> • <i>Blind/Shutter control without slat adjustment</i>: If a telegram is received, the movement is stopped. • <i>Blind/Shutter control with slat adjustment</i>: If a telegram is received, the movement is stopped and the slat position can be changed. <p>Telegram value:</p> <ul style="list-style-type: none"> • 1 = Stop / close slats • 0 = Stop / open slats 				
<p>Note With the functions <i>Weather alarms, Block, Forced operation</i> or <i>Automatic sun protection</i>, a telegram does not necessarily result in a change to the Blind/Shutter or slat position.</p>				
<p>Prerequisites for visibility</p> <ul style="list-style-type: none"> • Parameter window Configuration <ul style="list-style-type: none"> – Parameter Enable output X + Y \ Option Yes – Parameter Application \ Option <i>Shutter Actuator</i> • Parameter window Shutter Actuator X+Y \ Parameter window Shutter Actuator functions \ Parameter Operating mode \ Option <i>Blind/Shutter control with slat adjustment</i> 				
Move to position height	Channel X: Shutter	DPT 5.001	1 byte	C W
<p>This Group Object is used to receive, via the bus (ABB i-bus® KNX), the command for moving the Blind/Shutter to a defined position. After reaching the target position, the slat position is the same as before the movement. If a telegram is received on the Group Object Move to position slat during the movement, after the target position is reached the slats are set according to the value received.</p> <p>Telegram value:</p> <ul style="list-style-type: none"> • 0 % = Upper end position • 1 ... 99 % = Intermediate position • 100 % = Lower end position 				
<p>Note If the slat position was set manually using one of the following Group Objects, this setting will be discarded after the Blind/Shutter is moved.</p> <ul style="list-style-type: none"> • Slat adjustment / Stop Up/Down • Slat adjustment / Stop Up/Down (Central) 				
<p>Note With the functions <i>Weather alarms, Block, Forced operation</i> or <i>Automatic sun protection</i>, a telegram does not necessarily result in a change to the Blind/Shutter position.</p>				
<p>Prerequisites for visibility</p> <ul style="list-style-type: none"> • Parameter window Configuration <ul style="list-style-type: none"> – Parameter Enable output X + Y \ Option Yes – Parameter Application \ Option <i>Shutter Actuator</i> • Parameter window Shutter Actuator X+Y \ Parameter window Blind/Shutter <ul style="list-style-type: none"> – Parameter Parameter setting \ Option <i>Individual</i> – Parameter Enable Group Objects "Move to position Height/Slat" \ Option Yes 				

Function	Group Object name	Data point type	Length	Flags	
Move to position slat	Channel X: Shutter	DPT 5.001	1 byte	C	W
<p>This Group Object is used to receive, via the bus (ABB i-bus® KNX), the command to adjust the slats to a specified position. The slats are positioned after the movement is ended.</p> <p>Telegram value:</p> <ul style="list-style-type: none"> • 0 % = Fully open • 1 ... 99 % = Intermediate position • 100 % = Fully closed 					
<p>Note With the functions <i>Weather alarms</i>, <i>Block</i>, <i>Forced operation</i> or <i>Automatic sun protection</i>, a telegram does not necessarily result in a change to the slat position.</p>					
<p>Prerequisites for visibility</p> <ul style="list-style-type: none"> • Parameter window <i>Configuration</i> <ul style="list-style-type: none"> – Parameter <i>Enable output X + Y</i> \ Option <i>Yes</i> – Parameter <i>Application</i> \ Option <i>Shutter Actuator</i> • Parameter window <i>Shutter Actuator X+Y</i> \ Parameter window <i>Shutter Actuator functions</i> \ Parameter <i>Operating mode</i> \ Option <i>Blind/Shutter control with slat adjustment</i> • Parameter window <i>Shutter Actuator X+Y</i> \ Parameter window <i>Blind/Shutter</i> <ul style="list-style-type: none"> – Parameter <i>Parameter setting</i> \ Option <i>Individual</i> – Parameter <i>Enable Group Objects "Move to position Height/Slat"</i> \ Option <i>Yes</i> 					
Trigger reference movement	Channel X: Shutter	DPT 1.008	1 bit	C	W
<p>This Group Object is used to receive, via the bus (ABB i-bus® KNX), the command to perform a reference movement. More information: → reference movement, Page 286.</p> <p>Telegram value:</p> <ul style="list-style-type: none"> • 1 = Reference movement to lower end position • 0 = Reference movement to upper end position 					
<p>Note The reference movement cannot be performed while a safety function is active. The following actions will interrupt an active reference movement:</p> <ul style="list-style-type: none"> • Receipt of a shutter safety telegram → Safety functions of Shutter Actuator, Page 88 • Receipt of a direct command → Direct operation, Page 102 • Activation of manual operation <p>A reference movement can be performed even if direct operation is blocked (via Group Object <i>Block direct operation</i>).</p>					
<p>Prerequisites for visibility</p> <ul style="list-style-type: none"> • Parameter window <i>Configuration</i> <ul style="list-style-type: none"> – Parameter <i>Enable output X + Y</i> \ Option <i>Yes</i> – Parameter <i>Application</i> \ Option <i>Shutter Actuator</i> • Parameter window <i>Shutter Actuator X+Y</i> \ Parameter window <i>Drive</i> <ul style="list-style-type: none"> – Parameter <i>Parameter setting</i> \ Option <i>Individual</i> – Parameter <i>Enable Group Object "Trigger reference movement"</i> \ Option <i>Yes</i> 					
Sun	Channel X: Shutter	DPT 1.002	1 bit	C	W T U
<p>This Group Object is used to receive, via the bus (ABB i-bus® KNX), the sunshine situation (Sun = 1 or Sun = 0) for activating the function <i>Automatic sun protection</i>. More information: → Function Automatic sun protection, Page 100.</p> <p>Telegram value:</p> <ul style="list-style-type: none"> • 1 = Sunshine (Sun = 1) • 0 = No sunshine (Sun = 0) 					
<p>Prerequisites for visibility</p> <ul style="list-style-type: none"> • Parameter window <i>Configuration</i> <ul style="list-style-type: none"> – Parameter <i>Enable output X + Y</i> \ Option <i>Yes</i> – Parameter <i>Application</i> \ Option <i>Shutter Actuator</i> • Parameter window <i>Shutter Actuator X+Y</i> \ Parameter window <i>Shutter Actuator functions</i> \ Parameter <i>Enable function Automatic sun protection</i> \ Option <i>Yes</i> 					
Sun: Move to height	Channel X: Shutter	DPT 5.001	1 byte	C	W T U
<p>This Group Object is used to receive, via the bus (ABB i-bus® KNX), the direct activation of the Blind/Shutter position. More information: → Function Automatic sun protection, Page 100.</p> <p>Telegram value:</p> <ul style="list-style-type: none"> • 0 % = Upper end position • 1 % ... 99 % = Intermediate position • 100 % = Lower end position 					
<p>Prerequisites for visibility</p> <ul style="list-style-type: none"> • Parameter window <i>Configuration</i> <ul style="list-style-type: none"> – Parameter <i>Enable output X + Y</i> \ Option <i>Yes</i> – Parameter <i>Application</i> \ Option <i>Shutter Actuator</i> • Parameter window <i>Shutter Actuator X+Y</i> \ Parameter window <i>Shutter Actuator functions</i> \ Parameter <i>Enable function Automatic sun protection</i> \ Option <i>Yes</i> • Parameter window <i>Shutter Actuator X+Y</i> \ Parameter window <i>Automatic sun protection</i> <ul style="list-style-type: none"> – Parameter <i>Parameter setting</i> \ Option <i>Individual</i> – Parameter <i>Reaction on sun = 1 (sun)</i> \ Option <i>Receive height and slat via Group Objects</i> or <ul style="list-style-type: none"> – Parameter <i>Reaction on sun = 0 (no sun)</i> \ Option <i>Receive height and slat via Group Objects</i> 					

Function	Group Object name	Data point type	Length	Flags
Sun: Move slat	Channel X: Shutter	DPT 5.001	1 byte	C W T U

This Group Object is used to receive, via the bus (ABB i-bus® KNX), the direct activation of the slat position.
 More information: → [Function Automatic sun protection, Page 100](#).

Telegram value:

- 0 % = Open slats
- 1 % ... 99 % = Intermediate position
- 100 % = Close slats



Note

The slats are positioned only after the Blind/Shutter reaches the target position.

Prerequisites for visibility

- Parameter window [Configuration](#)
 - Parameter [Enable output X + Y](#) \ Option Yes
 - Parameter [Application](#) \ Option *Shutter Actuator*
- Parameter window [Shutter Actuator X+Y](#) \ Parameter window [Shutter Actuator functions](#)
 - Parameter [Operating mode](#) \ Option *Blind/Shutter control with slat adjustment*
 - Parameter [Enable function Automatic sun protection](#) \ Option Yes
- Parameter window [Shutter Actuator X+Y](#) \ Parameter window [Automatic sun protection](#)
 - Parameter [Parameter setting](#) \ Option *Individual*
 - Parameter [Reaction on sun = 1 \(sun\)](#) \ Option *Receive height and slat via Group Objects / Receive only slat via Group Object*
 or
- Parameter [Reaction on sun = 0 \(no sun\)](#) \ Options *Receive height and slat via Group Objects / Receive only slat via Group Object*

Activate/Deactivate Automatic sun protection	Channel X: Shutter	DPT 1.003	1 bit	C W T U
--	--------------------	-----------	-------	---------

This Group Object is used to Activate/Deactivate the function *Automatic sun protection* via the bus (ABB i-bus® KNX).
 More information: → [Function Automatic sun protection, Page 100](#).

Telegram value:

- 1 = Activate Automatic sun protection, deactivate direct operation
- 0 = Deactivate Automatic sun protection, activate direct operation

Prerequisites for visibility

- Parameter window [Configuration](#)
 - Parameter [Enable output X + Y](#) \ Option Yes
 - Parameter [Application](#) \ Option *Shutter Actuator*
- Parameter window [Shutter Actuator X+Y](#) \ Parameter window [Shutter Actuator functions](#) \ Parameter [Enable function Automatic sun protection](#) \ Option Yes

Block Automatic sun protection	Channel X: Shutter	DPT 1.003	1 bit	C W T U
--------------------------------	--------------------	-----------	-------	---------

This Group Object is used to block/unblock, via the bus (ABB i-bus® KNX), the function *Automatic sun protection*.
 More information: → [Function Automatic sun protection, Page 100](#).

Telegram value:

- 1 = Block function *Automatic sun protection*
- 0 = Unblock function *Automatic sun protection*

Prerequisites for visibility

- Parameter window [Configuration](#)
 - Parameter [Enable output X + Y](#) \ Option Yes
 - Parameter [Application](#) \ Option *Shutter Actuator*
- Parameter window [Shutter Actuator X+Y](#) \ Parameter window [Shutter Actuator functions](#) \ Parameter [Enable function Automatic sun protection](#) \ Option Yes
- Parameter window [Shutter Actuator X+Y](#) \ Parameter window [Automatic sun protection](#)
 - Parameter [Parameter setting](#) \ Option *Individual*
 - Parameter [Enable Group Object "Block automatic sun protection"](#) \ Option Yes

Block	Channel X: Shutter	DPT 1.003	1 bit	C W
-------	--------------------	-----------	-------	-----

This Group Object is used to Activate/Deactivate the safety function *Block*.
 More information: → [Block, Page 90](#)

Telegram value:

- 1 = Activate block
- 0 = Deactivate block

Prerequisites for visibility

- Parameter window [Configuration](#)
 - Parameter [Enable output X + Y](#) \ Option Yes
 - Parameter [Application](#) \ Option *Shutter Actuator*
- Parameter window [Shutter Actuator X+Y](#) \ Parameter window [Shutter Actuator functions](#) \ Parameter [Enable function Safety/Weather alarms](#) \ Option Yes
- Parameter window [Shutter Actuator X+Y](#) \ Parameter window [Safety/Weather alarms](#)
 - Parameter [Parameter setting](#) \ Option *Individual*
 - Parameter [Blind/Shutter reaction on block](#) \ all options except *No reaction/deactivated*

Function	Group Object name	Data point type	Length	Flags
Status Operability	Channel X: Shutter	DPT 1.011	1 bit	C R T
<p>This Group Object sends the status of the operability via direct commands on the bus (ABB i-bus® KNX). The send behavior depends on the setting in the parameter <i>Send value of Group Object "Status Operability"</i>. More information: → Direct operation, Page 102. Telegram value:</p> <ul style="list-style-type: none"> • 1 = Operability enabled • 0 = Operability not enabled 				
<p>Note The operability via direct commands is not enabled in the following cases:</p> <ul style="list-style-type: none"> • One of the safety functions is active → Safety functions of Shutter Actuator, Page 88 • Automatic sun protection is active and can only be deactivated via the Group Object Activate/Deactivate Automatic sun protection • Automatic sun protection is active and direct operation is blocked via the Group Object Block direct operation • The device is in the <i>Manual operation</i> operating mode 				
<p>Note This Group Object can be used to display on an external control unit that operability via direct commands is not possible.</p>				
<p>Prerequisites for visibility</p> <ul style="list-style-type: none"> • Parameter window Configuration <ul style="list-style-type: none"> – Parameter Enable output X + Y \ Option Yes – Parameter Application \ Option <i>Shutter Actuator</i> • Parameter window Shutter Actuator X+Y \ Parameter window status messages <ul style="list-style-type: none"> – Parameter Parameter setting \ Option <i>Individual</i> – Parameter Enable Group Object "Status Operability" \ Option Yes 				
Status Upper end position	Channel X: Shutter	DPT 1.011	1 bit	C R T
<p>This Group Object sends the status of the Blind/Shutter position (upper end position) on the bus (ABB i-bus® KNX). The send behavior depends on the setting in the parameter <i>Send value of Group Objects "Status Upper/Lower end position"</i>. Telegram value:</p> <ul style="list-style-type: none"> • 1 = Blind/shutter in upper end position • 0 = Blind/shutter not in upper end position 				
<p>Prerequisites for visibility</p> <ul style="list-style-type: none"> • Parameter window Configuration <ul style="list-style-type: none"> – Parameter Enable output X + Y \ Option Yes – Parameter Application \ Option <i>Shutter Actuator</i> • Parameter window Shutter Actuator X+Y \ Parameter window status messages <ul style="list-style-type: none"> – Parameter Parameter setting \ Option <i>Individual</i> – Parameter Enable Group Objects "Status Upper/Lower end position" \ Option Yes 				
Status Lower end position	Channel X: Shutter	DPT 1.011	1 bit	C R T
<p>This Group Object sends the status of the Blind/Shutter position (lower end position) on the bus (ABB i-bus® KNX). The send behavior depends on the setting in the parameter <i>Send value of Group Objects "Status Upper/Lower end position"</i>. Telegram value:</p> <ul style="list-style-type: none"> • 1 = Blind/shutter in lower end position • 0 = Blind/shutter not in lower end position 				
<p>Prerequisites for visibility</p> <ul style="list-style-type: none"> • Parameter window Configuration <ul style="list-style-type: none"> – Parameter Enable output X + Y \ Option Yes – Parameter Application \ Option <i>Shutter Actuator</i> • Parameter window Shutter Actuator X+Y \ Parameter window status messages <ul style="list-style-type: none"> – Parameter Parameter setting \ Option <i>Individual</i> – Parameter Enable Group Objects "Status Upper/Lower end position" \ Option Yes 				
Status Height	Channel X: Shutter	DPT 5.001	1 byte	C R T
<p>This Group Object sends the height of the Blind/Shutter on the bus (ABB i-bus® KNX). The send behavior depends on the setting in the parameter <i>Send value of Group Objects "Status Height/Slat"</i>. Telegram value:</p> <ul style="list-style-type: none"> • 0 % = Upper end position • 1 % ... 99 % = Intermediate position • 100 % = Lower end position 				
<p>Prerequisites for visibility</p> <ul style="list-style-type: none"> • Parameter window Configuration <ul style="list-style-type: none"> – Parameter Enable output X + Y \ Option Yes – Parameter Application \ Option <i>Shutter Actuator</i> • Parameter window Shutter Actuator X+Y \ Parameter window status messages <ul style="list-style-type: none"> – Parameter Parameter setting \ Option <i>Individual</i> – Parameter Enable Group Objects "Status Height/Slat" \ Option Yes 				

Function	Group Object name	Data point type	Length	Flags
Status Slat	Channel X: Shutter	DPT 5.001	1 byte	C R T

This Group Object sends the position of the slats on the bus (ABB i-bus® KNX).

The send behavior depends on the setting in the parameter [Send value of Group Objects "Status Height/Slat"](#).

Telegram value:

- 0 % = Slats open
- 1 % ... 99 % = Intermediate position
- 100 % = Slats closed

Prerequisites for visibility

- Parameter window [Configuration](#)
 - Parameter [Enable output X + Y](#) \ Option Yes
 - Parameter [Application](#) \ Option *Shutter Actuator*
- Parameter window [Shutter Actuator X+Y](#) \ Parameter window [Shutter Actuator functions](#) \ Parameter [Operating mode](#) \ Option *Blind/Shutter control with slat adjustment*
- Parameter window [Shutter Actuator X+Y](#) \ Parameter window [status messages](#)
 - Parameter [Parameter setting](#) \ Option *Individual*
 - Parameter [Enable Group Objects "Status Height/Slat"](#) \ Option Yes

Status Automatic sun protection	Channel X: Shutter	DPT 1.011	1 bit	C R T
---------------------------------	--------------------	-----------	-------	-------

This Group Object sends the status of the Automatic sun protection on the bus (ABB i-bus® KNX).

The send behavior depends on the setting in the parameter [Send value of Group Object "Status Automatic sun protection"](#).

Telegram value:

- 1 = Automatic sun protection active
- 0 = Automatic sun protection inactive



Note

This Group Object can be used to display the status of the Automatic sun protection on an external control unit.

Prerequisites for visibility

- Parameter window [Configuration](#)
 - Parameter [Enable output X + Y](#) \ Option Yes
 - Parameter [Application](#) \ Option *Shutter Actuator*
- Parameter window [Shutter Actuator X+Y](#) \ Parameter window [status messages](#)
 - Parameter [Parameter setting](#) \ Option *Individual*
 - Parameter [Enable Group Object "Status Automatic sun protection"](#) \ Option Yes

Status byte all active priorities	Channel X: Shutter	nonDPT	1 byte	C R T
-----------------------------------	--------------------	--------	--------	-------

This Group Object sends the status of all active priorities on the bus (ABB i-bus® KNX).

The send behavior depends on the setting in the parameter [Send value of Group Objects "Status byte" \[Shutter Actuator\]](#).

Telegram value:

- Bit 0: Manual operation
 - 1 = Active
 - 0 = Inactive
- Bit 1: Block
 - 1 = Active
 - 0 = Inactive
- Bit 2: forced operation
 - 1 = Active
 - 0 = Inactive
- Bit 3: Frost alarm
 - 1 = Active
 - 0 = Inactive
- Bit 4: Rain alarm
 - 1 = Active
 - 0 = Inactive
- Bit 5: Wind alarm
 - 1 = Active
 - 0 = Inactive
- Bit 6: Automatic sun protection
 - 1 = Active
 - 0 = Inactive
- Bit 7: i-bus® Tool
 - 1 = Active
 - 0 = Inactive

More information: → [Table of values, Group Object "Status byte all active priorities" \(Shutter Actuator\), Page 297.](#)

Prerequisites for visibility

- Parameter window [Configuration](#)
 - Parameter [Enable output X + Y](#) \ Option Yes
 - Parameter [Application](#) \ Option *Shutter Actuator*
- Parameter window [Shutter Actuator X+Y](#) \ Parameter window [status messages](#)
 - Parameter [Parameter setting](#) \ Option *Individual*
 - Parameter [Enable Group Objects "Status byte" \[Shutter Actuator\]](#) \ Option Yes, *all active priorities*

Function	Group Object name	Data point type	Length	Flags
Status byte highest active priority	Channel X: Shutter	nonDPT	1 byte	C R T
<p>This Group Object sends the status of the highest active priority on the bus (ABB i-bus® KNX). The send behavior depends on the setting in the parameter Send value of Group Objects "Status byte" [Shutter Actuator]. Telegram value:</p> <ul style="list-style-type: none"> 0: No priority active (operating mode <i>KNX operation</i>) 1: Manual operation active 2: Block active 3: Forced operation active 4: Frost alarm active 5: Rain alarm active 6: Wind alarm active 7: Automatic sun protection active 8: i-bus® Tool active 9 ... 255: Not used <p>Prerequisites for visibility</p> <ul style="list-style-type: none"> Parameter window Configuration <ul style="list-style-type: none"> Parameter Enable output X + Y \ Option <i>Yes</i> Parameter Application \ Option <i>Shutter Actuator</i> Parameter window Shutter Actuator X+Y \ Parameter window status messages <ul style="list-style-type: none"> Parameter Parameter setting \ Option <i>Individual</i> Parameter Enable Group Objects "Status byte" [Shutter Actuator] \ Option <i>Yes, highest active priority</i> 				
Stop Up/Down	Channel X: Shutter	DPT 1.007	1 bit	C W
<p>This Group Object is used to receive, via the bus (ABB i-bus® KNX), the command to stop a movement. Telegram value:</p> <ul style="list-style-type: none"> 1 = Stop 0 = Stop <p>Prerequisites for visibility</p> <ul style="list-style-type: none"> Parameter window Configuration <ul style="list-style-type: none"> Parameter Enable output X + Y \ Option <i>Yes</i> Parameter Application \ Option <i>Shutter Actuator</i> Parameter window Shutter Actuator X+Y \ Parameter window Shutter Actuator functions \ Parameter Operating mode \ Option <i>Blind/Shutter control without slat adjustment</i> 				
Scene 1 ... 64	Channel X: Shutter	DPT 18.001	1 byte	C W
<p>This Group Object is used to receive, via the bus (ABB i-bus® KNX), a Scene telegram. The Scene telegram includes the Scene number and information about whether the Scene is recalled or the position of the Blind/Shutter and the slats is saved in the Scene. A Scene number is assigned in the parameter window Scene assignments [Shutter Actuator]. If the corresponding Scene number is parametrized for an output, the Scene is recalled or saved, depending on the telegram value. Telegram value:</p> <ul style="list-style-type: none"> 0 ... 63 = Recall Scene x (x = 1 ... 64) 128 ... 191 = Save Scene x (x = 1 ... 64) <p>For more information, see:</p> <ul style="list-style-type: none"> → Function Scenes, Page 102 → Function diagram Shutter Actuator, Page 86 → Table of values, Group Object "Scene 1 ... 64", Page 299 				
<p>Note A telegram does not necessarily result in a change to the Blind/Shutter position due to the priorities.</p>				
<p>Prerequisites for visibility</p> <ul style="list-style-type: none"> Parameter window Configuration <ul style="list-style-type: none"> Parameter Enable output X + Y \ Option <i>Yes</i> Parameter Application \ Option <i>Shutter Actuator</i> Parameter window Shutter Actuator X+Y \ Parameter window Shutter Actuator functions \ Parameter Enable function Scenes [Shutter Actuator] \ Option <i>Yes</i> 				
Recall Scene assignment x	Channel X: Shutter	DPT 1.017	1 bit	C W
<p>This Group Object is used to receive, via the bus (ABB i-bus® KNX), a Scene assignment. Telegram value:</p> <ul style="list-style-type: none"> 1 = Recall scene assignment x (x = 1 ... 4) 0 = Recall Scene assignment x (x = 1 ... 4) <p>Prerequisites for visibility</p> <ul style="list-style-type: none"> Parameter window Configuration <ul style="list-style-type: none"> Parameter Enable output X + Y \ Option <i>Yes</i> Parameter Application \ Option <i>Shutter Actuator</i> Parameter window Shutter Actuator X+Y \ Parameter window Shutter Actuator functions \ Parameter Enable function Scenes [Shutter Actuator] \ Option <i>Yes</i> Parameter window Shutter Actuator X+Y \ Parameter window Scene assignments [Shutter Actuator] <ul style="list-style-type: none"> Parameter Parameter setting \ Option <i>Individual</i> Parameter Enable Scene assignment x [Shutter Actuator] \ Option <i>Yes</i> Parameter Recall Scene x also via 1-bit Group Object \ Option <i>Yes</i> 				

Function	Group Object name	Data point type	Length	Flags	
Forced operation, 1-bit	Channel X: Shutter	DPT 1.003	1 bit	C	W
<p>This Group Object is used to Activate/Deactivate 1-bit forced operation via the bus (ABB i-bus® KNX). For more information, see: → forced operation, Page 90. Telegram value:</p> <ul style="list-style-type: none"> Depends on the setting in the parameter Forced operation (1 bit / 2 bit) [Shutter Actuator] <p>Prerequisites for visibility</p> <ul style="list-style-type: none"> Parameter window Configuration <ul style="list-style-type: none"> Parameter Enable output X + Y \ Option Yes Parameter Application \ Option Shutter Actuator Parameter window Shutter Actuator X+Y \ Parameter window Shutter Actuator functions \ Parameter Enable function Safety/Weather alarms \ Option Yes Parameter window Shutter Actuator X+Y \ Parameter window Safety/Weather alarms <ul style="list-style-type: none"> Parameter Parameter setting \ Option Individual Parameter Forced operation (1 bit / 2 bit) [Shutter Actuator] \ Option Activated 1 bit – 0 active / Activated 1 bit – 1 active 					
Forced operation, 2-bit	Channel X: Shutter	DPT 2.001	2 bit	C	W
<p>This Group Object is used to Activate/Deactivate 2-bit forced operation via the bus (ABB i-bus® KNX). For more information, see: → forced operation, Page 90. Telegram value (bit 1 bit 0):</p> <ul style="list-style-type: none"> 0 0 = Forced operation inactive 0 1 = Forced operation inactive 1 0 = Forced operation active "OFF" 1 1 = Forced operation active "ON" <p>Prerequisites for visibility</p> <ul style="list-style-type: none"> Parameter window Configuration <ul style="list-style-type: none"> Parameter Enable output X + Y \ Option Yes Parameter Application \ Option Shutter Actuator Parameter window Shutter Actuator X+Y \ Parameter window Shutter Actuator functions \ Parameter Enable function Safety/Weather alarms \ Option Yes Parameter window Shutter Actuator X+Y \ Parameter window Safety/Weather alarms <ul style="list-style-type: none"> Parameter Parameter setting \ Option Individual Parameter Forced operation (1 bit / 2 bit) [Shutter Actuator] \ Option Activated 2 bit 					

8.7 Group Objects "Channel X": Switch

Function	Group Object name	Data point type	Length	Flags	
Flashing	Channel X: Switch	DPT 1.001	1 bit	C	W
<p>This Group Object is used to start/stop, via the bus (ABB i-bus® KNX), the flashing. More information: → Function Flashing, Page 107. Telegram value:</p> <ul style="list-style-type: none"> Depends on the setting in the parameter Flashing if Group Object "Flashing" is <div style="background-color: #f0f0f0; padding: 5px;"> <p>Note The relays can perform only a limited number of switching operations per minute. Frequent switching can cause a switching delay. More information → Technical data.</p> </div> <p>Prerequisites for visibility</p> <ul style="list-style-type: none"> Parameter window Configuration <ul style="list-style-type: none"> Parameter Enable output X + Y \ Option Yes Parameter Application \ Option Switch Actuator Parameter window Switch Actuator X \ Parameter window Functions Switch Actuator \ Parameter Enable function Time \ Option Flashing 					
Block delay for switching on and off	Channel X: Switch	DPT 1.003	1 bit	C	W
<p>This Group Object is used to enable or block, via the bus (ABB i-bus® KNX), the function Delay for switching on and off. Telegram value:</p> <ul style="list-style-type: none"> 1 = Block function Delay for switching on and off 0 = Enable function Delay for switching on and off <div style="background-color: #f0f0f0; padding: 5px;"> <p>Note If a delay was set in a Scene assignment in the parameter Delay, this Group Object is also used to block the delay of the execution of the Scene.</p> </div> <p>Prerequisites for visibility</p> <ul style="list-style-type: none"> Parameter window Configuration <ul style="list-style-type: none"> Parameter Enable output X + Y \ Option Yes Parameter Application \ Option Switch Actuator Parameter window Switch Actuator X \ Parameter window Functions Switch Actuator \ Parameter Enable function Time \ Option Delay for switching on and off Parameter window Switch Actuator X \ Parameter window Delay for switching on and off <ul style="list-style-type: none"> Parameter Parameter setting \ Option Individual Parameter Block delay for switching on and off via Group Object \ Option Yes 					

Function	Group Object name	Data point type	Length	Flags
Switch	Channel X: Switch	DPT 1.001	1 bit	C W
<p>This Group Object is used to receive a switch telegram via the bus (ABB i-bus® KNX). The switching behavior depends on the setting in the parameter Reaction of output. NO contact telegram value:</p> <ul style="list-style-type: none"> • 1 = Close relay contact • 0 = Open relay contact <p>NC contact telegram value:</p> <ul style="list-style-type: none"> • 1 = Open relay contact • 0 = Close relay contact 				
<p>Note Due to the priorities, a switching command does not necessarily change the position of the relay contact. Each relay can perform only a limited number of switching operations per minute. Frequent switching can cause a switching delay. More information → Technical data.</p>				
<p>Prerequisites for visibility</p> <ul style="list-style-type: none"> • Parameter window Configuration <ul style="list-style-type: none"> – Parameter Enable output X + Y \ Option <i>Yes</i> – Parameter Application \ Option <i>Switch Actuator</i> 				
Block	Channel X: Switch	DPT 1.003	1 bit	C W
<p>This Group Object is used to Activate/Deactivate the safety function <i>Block</i>. More information: → Block, Page 92. Telegram value:</p> <ul style="list-style-type: none"> • 1 = Activate block • 0 = Deactivate block 				
<p>Prerequisites for visibility</p> <ul style="list-style-type: none"> • Parameter window Configuration <ul style="list-style-type: none"> – Parameter Enable output X + Y \ Option <i>Yes</i> – Parameter Application \ Option <i>Switch Actuator</i> • Parameter window Switch Actuator X \ Parameter window Functions Switch Actuator \ Parameter Enable function Safety \ Option <i>Yes</i> • Parameter window Switch Actuator X \ Parameter window Safety <ul style="list-style-type: none"> – Parameter Parameter setting \ Option <i>Individual</i> – Parameter Switching reaction on block \ Options <i>On / Off / Unchanged (block)</i> 				
Status Switch	Channel X: Switch	DPT 1.011	1 bit	C R T
<p>This Group Object sends the position of the relay contact on the bus (ABB i-bus® KNX). The send behavior depends on the setting in the parameter Send value of Group Object "Status Switch". Telegram value:</p> <ul style="list-style-type: none"> • Depends on the setting in the parameter Value of Group Object "Status Switch" 				
<p>Prerequisites for visibility</p> <ul style="list-style-type: none"> • Parameter window Configuration <ul style="list-style-type: none"> – Parameter Enable output X + Y \ Option <i>Yes</i> – Parameter Application \ Option <i>Switch Actuator</i> • Parameter window Switch Actuator X \ Parameter window Basic settings [Switch Actuator] <ul style="list-style-type: none"> – Parameter Parameter setting \ Option <i>Individual</i> – Parameter Feedback of contact position via Group Object "Status Switch" \ Option <i>Yes</i> 				

Function	Group Object name	Data point type	Length	Flags
Status byte all active priorities	Channel X: Switch	nonDPT	1 byte	C R T

This Group Object sends the status of all active priorities on the bus (ABB i-bus® KNX).

The send behavior depends on the setting in the parameter [Send value of Group Objects "Status byte" \[Switch Actuator\]](#).

Telegram value:

- Bit 0: Manual operation
 - 1 = Active
 - 0 = Inactive
- Bit 1: Block
 - 1 = Active
 - 0 = Inactive
- Bit 2: forced operation
 - 1 = Active
 - 0 = Inactive
- Bit 3: Safety priority 1
 - 1 = Active
 - 0 = Inactive
- Bit 4: Safety priority 2
 - 1 = Active
 - 0 = Inactive
- Bit 5: Safety priority 3
 - 1 = Active
 - 0 = Inactive
- Bit 6: Load shedding
 - 1 = Active
 - 0 = Inactive
- Bit 7: i-bus® Tool
 - 1 = Active
 - 0 = Inactive

More information: → [Table of values, Group Object "Status byte all active priorities" \(Switch Actuator\), Page 295.](#)

Prerequisites for visibility

- Parameter window [Configuration](#)
 - Parameter [Enable output X + Y](#) \ Option Yes
 - Parameter [Application](#) \ Option *Switch Actuator*
- Parameter window [Switch Actuator X](#) \ Parameter window [Basic settings \[Switch Actuator\]](#)
 - Parameter [Parameter setting](#) \ Option *Individual*
 - Parameter [Enable Group Objects "Status byte" \[Switch Actuator\]](#) \ Option *Yes, all active priorities*

Status byte highest active priority	Channel X: Switch	nonDPT	1 byte	C R T
-------------------------------------	-------------------	--------	--------	-------

This Group Object sends the status of the highest active priority on the bus (ABB i-bus® KNX).

The send behavior depends on the setting in the parameter [Send value of Group Objects "Status byte" \[Switch Actuator\]](#).

Telegram value:

- 0: No priority active (operating mode *KNX operation*)
- 1: Manual operation active
- 2: Block active
- 3: Forced operation active
- 4: Safety priority 1 active
- 5: Safety priority 2 active
- 6: Safety priority 3 active
- 7: Load shedding active
- 8: i-bus® Tool active
- 9: Staircase lighting permanent on active
- 10: Flashing active
- 11 ... 255: Not used

Prerequisites for visibility

- Parameter window [Configuration](#) \
 - Parameter [Enable output X + Y](#) \ Option Yes
 - Parameter [Application](#) \ Option *Switch Actuator*
- Parameter window [Switch Actuator X](#) \ Parameter window [Basic settings \[Switch Actuator\]](#)
 - Parameter [Parameter setting](#) \ Option *Individual*
 - Parameter [Enable Group Objects "Status byte" \[Switch Actuator\]](#) \ Option *Yes, highest active priority*

Function	Group Object name	Data point type	Length	Flags
Scene 1 ... 64	Channel X: Switch	DPT 18.001	1 byte	C W
<p>This Group Object is used to receive, via the bus (ABB i-bus® KNX), a Scene telegram.</p> <p>The Scene telegram includes the Scene number and information about whether the Scene is recalled or the position of the relay contact is saved in the Scene. A Scene number is assigned in the parameter window Scene assignments [Switch Actuator]. If the corresponding Scene number is parametrized for an output, the Scene is recalled or saved, depending on the telegram value.</p> <p>Telegram value:</p> <ul style="list-style-type: none"> 0 ... 63 = Recall Scene x (x = 1 ... 64) 128 ... 191 = Save Scene x (x = 1 ... 64) <p>For more information, see:</p> <ul style="list-style-type: none"> → Function Scenes, Page 102 → Function diagram Switch Actuator, Page 87 → Table of values, Group Object "Scene 1 ... 64", Page 299 				
<p>Note</p> <p>A telegram does not necessarily result in a change to the position of the relay contact due to the priorities.</p>				
<p>Prerequisites for visibility</p> <ul style="list-style-type: none"> Parameter window Configuration <ul style="list-style-type: none"> Parameter Enable output X + Y \ Option Yes Parameter Application \ Option Switch Actuator Parameter window Switch Actuator X \ Parameter window Functions Switch Actuator \ Parameter Enable function Scenes [Switch Actuator] \ Option Yes 				
Recall Scene assignment x	Channel X: Switch	DPT 1.017	1 bit	C W
<p>This Group Object is used to receive, via the bus (ABB i-bus® KNX), a Scene assignment.</p> <p>Telegram value:</p> <ul style="list-style-type: none"> 1 = Recall scene assignment x (x = 1 ... 4) 0 = Recall Scene assignment x (x = 1 ... 4) <p>Prerequisites for visibility</p> <ul style="list-style-type: none"> Parameter window Configuration <ul style="list-style-type: none"> Parameter Enable output X + Y \ Option Yes Parameter Application \ Option Switch Actuator Parameter window Switch Actuator X \ Parameter window Functions Switch Actuator \ Parameter Enable function Scenes [Switch Actuator] \ Option Yes Parameter window Switch Actuator X \ Parameter window Scene assignments [Switch Actuator] <ul style="list-style-type: none"> Parameter Parameter setting \ Option Individual Parameter Enable Scene assignment x [Switch Actuator] \ Option Yes Parameter Recall Scene x also via 1-bit Group Object \ Option Yes 				
Staircase lighting permanent on	Channel X: Switch	DPT 1.001	1 bit	C W
<p>This Group Object is used to receive, via the bus (ABB i-bus® KNX), the command to start/stop permanent on operation.</p> <p>If the function <i>Staircase lighting</i> is active, the output can be permanently switched on via this Group Object. Other functions continue to run in the background, but they do not trigger any switching action.</p> <p>Telegram value:</p> <ul style="list-style-type: none"> 1 = Start permanent on operation 0 = End permanent on operation <p>Prerequisites for visibility</p> <ul style="list-style-type: none"> Parameter window Configuration <ul style="list-style-type: none"> Parameter Enable output X + Y \ Option Yes Parameter Application \ Option Switch Actuator Parameter window Switch Actuator X \ Parameter window Functions Switch Actuator \ Parameter Enable function Time \ Option Staircase lighting 				
Warning staircase lighting	Channel X: Switch	DPT 1.001	1 bit	C R T
<p>This Group Object sends a pre-warning on the bus (ABB i-bus® KNX) before switching off the output.</p> <p>More information: → Function Staircase lighting, Page 104.</p> <p>Telegram value:</p> <ul style="list-style-type: none"> 1 = Warning staircase lighting active 0 = Warning staircase lighting inactive <p>Prerequisites for visibility</p> <ul style="list-style-type: none"> Parameter window Configuration <ul style="list-style-type: none"> Parameter Enable output X + Y \ Option Yes Parameter Application \ Option Switch Actuator Parameter window Switch Actuator X \ Parameter window Functions Switch Actuator \ Parameter Enable function Time \ Option Staircase lighting Parameter window Switch Actuator X \ Parameter window Staircase lighting <ul style="list-style-type: none"> Parameter Parameter setting \ Option Individual Parameter Warning before switching off the staircase lighting \ Options Via Group Object / Via Group Object and short switching off 				
Block staircase lighting	Channel X: Switch	DPT 1.003	1 bit	C W
<p>This Group Object is used to enable or block, via the bus (ABB i-bus® KNX), the function <i>Staircase lighting</i>.</p> <p>Telegram value:</p> <ul style="list-style-type: none"> 1 = Block function <i>Staircase lighting</i> 0 = Enable function <i>Staircase lighting</i> <p>Prerequisites for visibility</p> <ul style="list-style-type: none"> Parameter window Configuration <ul style="list-style-type: none"> Parameter Enable output X + Y \ Option Yes Parameter Application \ Option Switch Actuator Parameter window Switch Actuator X \ Parameter window Functions Switch Actuator \ Parameter Enable function Time \ Option Staircase lighting Parameter window Switch Actuator X \ Parameter window Staircase lighting <ul style="list-style-type: none"> Parameter Parameter setting \ Option Individual Parameter Block staircase lighting via Group Object \ Option Yes 				

Function	Group Object name	Data point type	Length	Flags
Staircase lighting time	Channel X: Switch	DPT 7.005	2 bytes	C W
This Group Object is used to receive, via the bus (ABB i-bus® KNX), the duration of the staircase lighting time.				
Telegram value:				
<ul style="list-style-type: none"> 0 ... 65,535 s 				
Prerequisites for visibility				
<ul style="list-style-type: none"> Parameter window Configuration <ul style="list-style-type: none"> Parameter Enable output X + Y \ Option Yes Parameter Application \ Option Switch Actuator Parameter window Switch Actuator X \ Parameter window Functions Switch Actuator \ Parameter Enable function Time \ Option Staircase lighting Parameter window Switch Actuator X \ Parameter window Staircase lighting <ul style="list-style-type: none"> Parameter Parameter setting \ Option Individual Parameter Change staircase lighting time via Group Object \ Option Yes 				
Forced operation, 1-bit	Channel X: Switch	DPT 1.003	1 bit	C W
This Group Object is used to Activate/Deactivate 1-bit forced operation via the bus (ABB i-bus® KNX).				
For more information, see: → forced operation, Page 92 .				
Telegram value:				
<ul style="list-style-type: none"> Depends on the setting in the parameter Forced operation (1 bit / 2 bit) [Switch Actuator] 				
Prerequisites for visibility				
<ul style="list-style-type: none"> Parameter window Configuration <ul style="list-style-type: none"> Parameter Enable output X + Y \ Option Yes Parameter Application \ Option Switch Actuator Parameter window Switch Actuator X \ Parameter window Functions Switch Actuator \ Parameter Enable function Safety \ Option Yes Parameter window Switch Actuator X \ Parameter window Safety <ul style="list-style-type: none"> Parameter Parameter setting \ Option Individual Parameter Forced operation (1 bit / 2 bit) [Switch Actuator] \ Options Activated 1 bit – 0 active / Activated 1 bit – 1 active 				
Forced operation, 2-bit	Channel X: Switch	DPT 2.001	2 bit	C W
This Group Object is used to Activate/Deactivate 2-bit forced operation via the bus (ABB i-bus® KNX).				
For more information, see: → forced operation, Page 92 .				
Telegram value (bit 1 bit 0):				
<ul style="list-style-type: none"> 0 0 = Forced operation inactive 0 1 = Forced operation inactive 1 0 = Forced operation active "OFF" 1 1 = Forced operation active "ON" 				
Prerequisites for visibility				
<ul style="list-style-type: none"> Parameter window Configuration <ul style="list-style-type: none"> Parameter Enable output X + Y \ Option Yes Parameter Application \ Option Switch Actuator Parameter window Switch Actuator X \ Parameter window Functions Switch Actuator \ Parameter Enable function Safety \ Option Yes Parameter window Switch Actuator X \ Parameter window Safety <ul style="list-style-type: none"> Parameter Parameter setting \ Option Individual Parameter Forced operation (1 bit / 2 bit) [Switch Actuator] \ Option Activated 2 bit 				

8.8 Group Objects "Channel X": Load shedding

Function	Group Object name	Data point type	Length	Flags
Set load shedding stage	Channel X: Load shedding	DPT 236.001	1 byte	C W
This Group Object is used to receive, via the bus (ABB i-bus® KNX), the load shedding stage for the channel.				
More information: → Function Load shedding, Page 95 .				
Telegram value:				
<ul style="list-style-type: none"> → Coding, Group Object "Set load shedding stage", Page 290 				
Prerequisites for visibility				
<ul style="list-style-type: none"> Parameter window Configuration <ul style="list-style-type: none"> Parameter Enable output X + Y \ Option Yes Parameter Application \ Option Switch Actuator Parameter window Device settings \ Parameter Enable central Group Object "Receive load shedding stage" \ Option Yes Parameter window Switch Actuator X \ Parameter window Functions Switch Actuator \ Parameter Enable function Load shedding \ Option Yes Parameter window Switch Actuator X \ Parameter window Load shedding <ul style="list-style-type: none"> Parameter Parameter setting \ Option Individual Parameter Change load shedding stage via Group Object \ Option Yes 				

Function	Group Object name	Data point type	Length	Flags
Status Load shedding	Channel X: Load shedding	DPT 1.011	1 bit	C R T

This Group Object sends the status of the load shedding on the bus (ABB i-bus® KNX).

The send behavior depends on the setting in the parameter *Send value of Group Object "Status Load shedding"*.

Telegram value:

- 1 = Load shedding active
- 0 = Load shedding inactive

Prerequisites for visibility

- Parameter window *Configuration*
 - Parameter *Enable output X + Y* \ Option *Yes*
 - Parameter *Application* \ Option *Switch Actuator*
- Parameter window *Device settings* \ Parameter *Enable central Group Object "Receive load shedding stage"* \ Option *Yes*
- Parameter window *Switch Actuator X* \ Parameter window *Functions Switch Actuator* \ Parameter *Enable function Load shedding* \ Option *Yes*
- Parameter window *Switch Actuator X* \ Parameter window *Load shedding*
 - Parameter *Parameter setting* \ Option *Individual*
 - Parameter *Enable group object "Status Load shedding"* \ Option *Yes*

9 Operation

9.1 Manual operation



CAUTION

The bus voltage supply must be established to operate the device in *Manual operation* mode.

Manual operation is ended in the event of bus voltage failure. The reaction of outputs to bus voltage failure can be set in the ETS application:

Shutter Actuator → [Blind/Shutter reaction on bus voltage failure, Page 161](#)

Switch Actuator → [Switching reaction on bus voltage failure, Page 200](#)

Manual operation mode permits on-site operation of the device using a membrane keypad.

The relays of the outputs can be switched manually. The relay switching states or the shutter movement position is additionally displayed in accordance with the selected output function.

The relay status is indicated in groups of four consecutive switching outputs or two consecutive shutter outputs. A mixture of switching and shutter outputs is possible, e.g. two switching outputs and one shutter output.

Depending on the parameterization as a switching output or shutter output, each relay can be operated individually as a switching output or two relays can be operated together as a shutter output.

In the as-delivered state, all outputs of the device are parameterized for operation as a Shutter Actuator. Manual operation is enabled and can be activated via the *S button* on the membrane keypad.

i Note

The safety functions (weather alarms as well as the functions *Safety priority*, *Forced operation* and *Block*) take priority over *Manual operation* mode. An output cannot be operated using the membrane keypad if it is blocked by a safety function. If the safety function is canceled in *Manual operation* operating mode, the output reacts corresponding to its parameterization.

i Note

When manual operation is active, the outputs will continue to react to KNX commands until they are switched via manual operation. If an output has been switched via manual operation, incoming KNX commands will be processed in the background and no longer executed until manual operation is deactivated.

More information: → [State after end of manual operation, Page 249](#).

After connection to the ABB i-bus® KNX, bus voltage recovery, ETS download or ETS reset, the device is in *KNX operation*. The *Manual operation* LED is off.

9.1.1 Central switch-off via membrane keypad

All outputs can be jointly switched off via the membrane keypad.

1. Select all outputs with a long button push (> 5 seconds) of the *S button*.
 - ⇒ All zone LEDs light up.
2. Press any *Output* (I ... IV) button.
 - ⇒ All outputs are switched off.

The first output group is selected automatically after the outputs switch off. Manual mode is exited, and the device is in *KNX operation*.

When switch-off is performed via the membrane keypad, the configuration of the outputs as NC contacts or NO contacts is taken into account.

NO contact:

- Relay contact open
- Status LED Off

NC contact:

- Relay contact closed
- Status LED On

If an output pair is parameterized as a Shutter Actuator, switch-off via the membrane keypad always opens the contacts. If the Blind/Shutter is moving, it will be stopped.

Note

The safety functions (weather alarms as well as the functions *Safety priority*, *Forced operation* and *Block*) take priority over *Manual operation* mode. An output cannot be operated using the membrane keypad if it is blocked by a safety function. If the safety function is canceled in *Manual operation* operating mode, the output reacts corresponding to its parameterization.

9.1.2 Activating manual operation

- ▶ Press and hold *S*-button for 2 ... 5 seconds.
- ⇒ *Manual operation* LED lights up. Manual operation is active.

Note

If manual operation is deactivated or blocked, *KNX operation* is not switched to the *Manual operation* mode. The LED remains off.

9.1.3 Blocking manual operation

The *Manual operation* mode can be blocked in various ways:

1. Via the parameter *Manual operation*.
 2. Via the Group Object *Enable/Block manual operation*.
- ⇒ Manual operation is blocked.

9.1.4 Ending manual operation

Manual operation mode can be ended in various ways:

1. Press and hold *S*-button for 2 ... 5 seconds.
 2. Automatically after a time set in the parameter *Automatic reset from manual operation to KNX operation*.
 3. By a download. Manual operation is not reactivated automatically after the download is complete.
 4. Via the Group Object *Ending manual operation*.
- ⇒ *Manual operation* LED goes out. Manual operation is ended.

10 Maintenance and cleaning

10.1 Maintenance

The device is maintenance-free if used properly. In the event of damage, e.g. during transport and/or storage, repairs are not allowed to be made.

10.2 Cleaning

1. Disconnect the device from the electrical power supply before cleaning.
2. Clean dirty devices using a dry cloth or a slightly damp cloth.

11 Removal and disposal

11.1 Removal

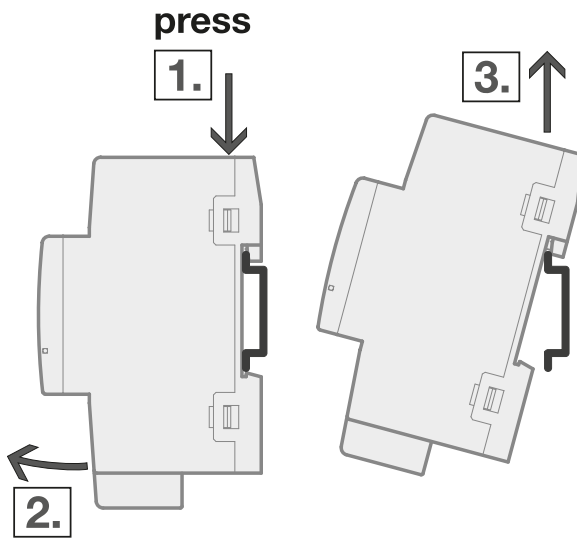

Fig. 57: Removing from the mounting rail

1. Press on the top of the device.
2. Release the bottom of the device from the mounting rail.
3. Lift the device up and off the mounting rail.

11.2 Environment

Consider environmental protection.

Electrical and electronic devices must not be disposed of as domestic waste.



The device contains valuable resources that can be recycled. Therefore, please take the device to a suitable recycling center. All packaging materials and devices are provided with markings and test seals for proper disposal. Always dispose of packaging material and electrical devices or their components at collection points or disposal companies authorized for this purpose. The products comply with the statutory requirements, particularly the law on electrical and electronic equipment and the REACH regulation. (EU directive 2012/19/EU WEEE and 2011/65/EU RoHS) (EU REACH regulation and the law implementing the regulation (EC) no.1907/2006)

12 Planning and application

12.1 Priorities

12.1.1 Priorities for Shutter Actuator

- a) Safety functions:
 - Weather alarms (device)
 - Forced operation (output)
 - Block (output)
- b) Bus voltage failure
- c) i-bus® Tool
- d) Operating mode *Manual operation*
- e) Operating mode *KNX operation*
- f) Bus voltage recovery

The order of priority for the safety functions can be defined individually in the parameter *Order of priority of weather alarm, block and forced operation* for each output. Additionally, the order of weather alarms can be defined for the overall device in the parameter *Order of priority for weather alarms*.

More information: → [Function diagram Shutter Actuator, Page 86](#).

i Note

The interface to i-bus® Tool is available from the following software versions:

- Application from V1.2
- Firmware from V0.2.0

12.1.2 Priorities for Switch Actuator

- a) Safety functions:
 - Safety priority 1 (device)
 - Forced operation (output)
 - Safety priority 2 (device)
 - Safety priority 3 (device)
 - Block (output)
- b) Bus voltage failure
- c) i-bus® Tool
- d) Operating mode *Manual operation*
- e) Load shedding
- f) Operating mode *KNX operation*
- g) Bus voltage recovery

More information: → [Function diagram Switch Actuator, Page 87](#).

i Note

The interface to i-bus® Tool is available from the following software versions:

- Application from V1.2
- Firmware from V0.2.0

12.2 Basic knowledge

12.2.1 AC-1, AC-3, AC-5, AX and C load

In Intelligent Building Control, different switching capacities and performance specifications required by special applications have become established for the industrial area and for building control. These performance specifications are rooted in the respective national and international standards. The tests are defined to simulate typical applications, e.g. motor loads (industrial) or fluorescent lamps (residential).

Industrial area

Specifications AC-1 and AC-3 are switching capacity specifications that have become established in the industrial field. These switching capacities are defined in the standard EN IEC 60947-4-1 "Low-voltage switchgear and controlgear – Part 4-1: Contactors and motor-starters – Electromechanical contactors and motor-starters". The standard describes starters and/or contactors that are used mainly in industrial applications.

Typical applications:

- AC-1 – non-inductive or slightly inductive load, resistance furnaces (relates to switching of ohmic loads, $\cos \varphi = 0.8$)
- AC-3 – squirrel-cage motors: starting, switching off motors during running (relates to (inductive) motor load, $\cos \varphi = 0.45$)
- AC-5a – switching of electric discharge lamps

Building control

The AX designation has come into use in the field of building control. AX refers to a (capacitive) fluorescent lighting load. The term "switchable capacitive loads" (200 μF , 140 μF , 70 μF or 35 μF) is used in connection with fluorescent lighting loads. These switching capacities are defined in the standard EN 60669 "Switches for household and similar fixed electrical installations". The standard describes switches that are used mainly in industrial applications. Testing with 70 μF is required for devices with a rated current of 6 A, testing with 140 μF for devices with a rated current > 6 A.

Comparison of AC and AX

The switching capacity specifications AC and AX are not directly comparable with each other. The following switching capacity qualities can be identified:

- Low switching capacity: AC-1 – primarily resistive loads
- Medium switching capacity: AX - fluorescent lighting loads according to EN 60669: 70 μF (6 A), 140 μF (10 A, 16 A)
- High switching capacity:
 - AC-3 - motor loads
 - C load - fluorescent lighting loads (200 μF)

The specifications AC-3 and AX are almost equivalent. A device that passed the test for AC3 according to DIN 60947 will very likely also pass the tests according to EN 60669 with 200 μF .

In summary the following can be stated:

- In the industrial area, the common designation is "AC-3 load".
- In building control, the common designation is "AX load" or "C load".

The switching capacity differences must be taken into account while selecting a Switch Actuator.

12.2.2 Drive settings

12.2.2.1 Travel times

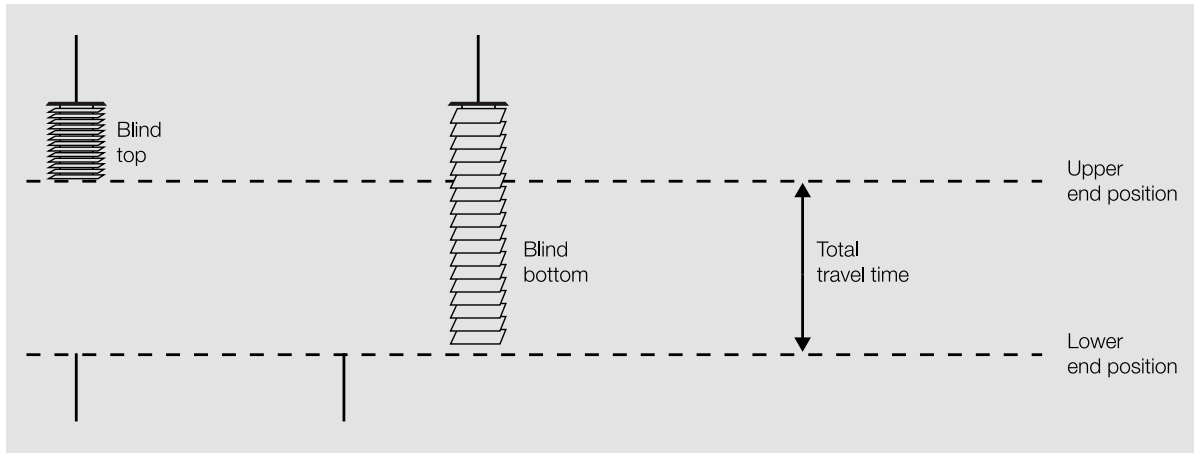

Fig. 58: Function diagram of travel times

The total travel time is the time that the Blind/Shutter requires to move from the lower to the upper end position (Up) or from the upper to the lower end position (Down). Total travel times for up and down movements can be determined separately and set in ETS.

If the device receives a movement telegram, then the appropriate output is switched and the Blind/Shutter moved in the required direction.

The Blind/Shutter is moved until the output receives a stop telegram or the end position is reached. The limit switch switches the drive off when the upper or lower end position is reached. The corresponding output contact remains closed until the parameterized travel time elapses.

If the travel time is extended by an overrun time, the voltage will be switched off only after this overrun time expires → [Disconnect output from power after, Page 158](#).

If a value not equal to 100 % is set in the parameter *Slat position after reaching lower end position (100 % = deactivated)*, the overrun time is not taken into account. The slats move to the parameterized position after reaching the lower end position.

12.2.2.1.1

Travel time determination

To determine the travel time, the travel times are measured from the lower to the upper end positions and vice-versa, e.g. using a stopwatch. The measured values are then entered in the parameters *Travel time up* and *Travel time down*.

Note

The travel times are used to determine the current position of the Blind/Shutter during operation. The travel times should therefore be measured and parameterized as accurately as possible.

For position movements, automatic control or status messages, precise travel times are the basis for exact calculation and positioning of the Blind/Shutter.

12.2.2.2 Blind/Shutter control with slat adjustment

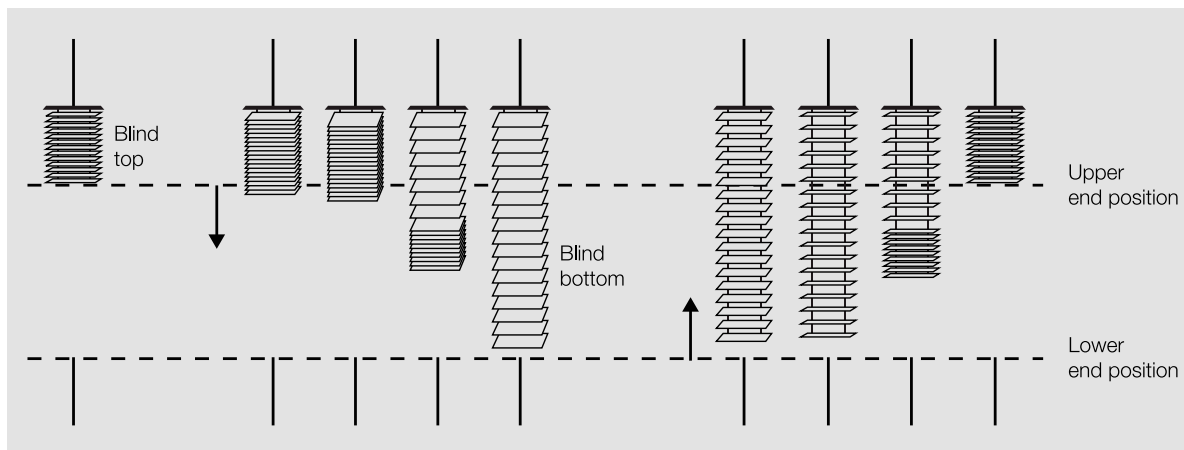

Fig. 59: Blind/Shutter control with slat adjustment

The slats are closed and the Blind/Shutter is moved down during a down movement. The slats are opened and the Blind/Shutter is moved up during an upward movement. After the Blind/Shutter moves up, the slats are usually open.

To adjust the slats to a specific angle, short movements can be executed. The Blind/Shutter is incrementally moved in the required direction for a time defined in the parameter *Duration of slat adjustment/step*. As an alternative it is possible to use the total duration for slat turning in the parameter *Determine slat adjustment time* for the determination of the switch-on duration.

The smaller the switch-on duration for slat adjustment is selected, the more accurately the slat angle can be adjusted.

12.2.2.3 reference movement

Each output continuously determines the current position of the Blind/Shutter and the slats based on the individual movements.

Temperature fluctuations and aging processes can cause slight inaccuracies in determining the position. In order to maintain high position accuracy, the position is updated in the device's memory when an end position is reached.

If travel range limits prevent the end positions from being reached, the Group Object *Trigger reference movement* can be used to trigger a reference movement to the upper or lower end position. After the reference movement, the Blind/Shutter is moved to the position defined in the parameter *Position after reference movement*.

The reference movement is performed automatically on the first movement command after starting the device (download, bus voltage recovery or ETS reset).

If a Blind/Shutter is moved to an end position by means of manual operation, this movement is evaluated as a reference movement.

If the output is blocked by an alarm, the reference movement is not to be performed automatically after the alarm is canceled.

If the reference movement was not completed, the position of the Blind/Shutter is unknown and is therefore not displayed.

The reference movement is canceled by a stop command.

12.2.2.4 Start-up and coasting delay and minimum run time

Some drives attain their full power only after a start-up delay of a few milliseconds or continue moving for a few milliseconds after switch-off (coasting delay). For some applications, it is necessary to compensate delay times during start-up and running-on of the drive, e.g. to position the Blinds/Shutters exactly. The delay times can be set in the parameters *Start-up delay* and *Coasting delay*.

The minimum run time for the drive can be set in the parameter *Minimum run time for drive*.



CAUTION

Setting a minimum run time that is too short can damage the connected drive.

- ▶ Observe the technical data of the connected drive.

12.2.3 Blind/Slat settings

12.2.3.1 Direct and indirect movement to the position

The parameter *Move to position* can be used to define how the Blind/Shutter is to move to the target position in response to a movement command.

- Direct: The Blind/Shutter is moved directly from its current position to the target position.
- Indirect: The Blind/Shutter is moved to the target position via the end position. It can be defined whether the Blind/Shutter is to move to the target position via the upper, lower or closer end position.

Indirect movement to the positions is used to position the Blind/Shutter. In order to maintain high position accuracy, the position is updated in the device's memory when an end position is reached.

12.2.3.2 Move to position 0 % ... 100 %

The Blind/Shutter can be moved to any position via the Group Object *Move to position height*.

The percentages refer to the position of the Blind/Shutter between the upper and lower end positions.

- 0 % = Upper end position
- 1 % ... 99 % = Intermediate position
- 100 % = Lower end position

In the *Blind/Shutter control with slat adjustment* operating mode, the slat can additionally be moved to any position via the Group Object *Move to position slat*.

The percentages refer to the opening degree of the slats.

- 0 % = Fully closed
- 1 % ... 99 % intermediate position
- 100 % = Fully open

12.2.3.3 Blind/Shutter control with slat adjustment

Two methods to control the slats and calculate the adjustment times can be selected in the parameter *Determine slat adjustment time*:

- *Via duration of slat adjustment*
- *Via total duration for slat turning*

The *Via duration of slat adjustment* method defines the duration and number of slat adjustments to move the slats from fully closed to fully open. The maximum number of slat adjustments is used to determine the current position of the slats during operation. The maximum number of slat adjustments must be counted by the commissioner and entered in the parameter *Number of slat adjustments/steps (from 0 % = open to 100 % = closed)*.

The *Via total duration for slat turning* method involves first determining the time required to move the slats from fully closed to fully open. Then, the desired number of slat adjustments (steps) is entered, with which the slats are to be adjusted from fully closed to fully open. The device uses the adjustment time and the steps to calculate the time for slat adjustment.

12.2.3.4 Travel range limit

The parameter *Limit travel range via Group Object* can be used to set a travel range limit for the output.

The *Move Blind/Shutter Up/Down limited* option is used to enable the Group Object *Move Blind/Shutter Up/Down limited*, which permits the Blind/Shutter to be moved only in a limited range.

The option *Activate limitation* is used to enable the Group Object *Activate/Deactivate limitation* via which the travel range limit is activated and deactivated. In addition to the travel range limit, it can be defined whether the upper and lower limit are to be implemented for direct telegrams and/or for Automatic sun protection telegrams.

The parameters *Upper limit (0 % = top; 100 % = bottom)* and *Lower limit (0 % = top; 100 % = bottom)* can be used to define the travel range for the Blind/Shutter.

Direct telegrams can be sent and received on the following central Group Objects:

- *Move Blind/Shutter Up/Down*
- *Slat adjustment / Stop Up/Down*
- *Move to position height*
- *Move to position slat*
- *Scene 1 ... 64*

Direct telegrams can be sent and received on the following output Group Objects:

- *Move Blind/Shutter Up/Down*
- *Stop Up/Down*
- *Slat adjustment / Stop Up/Down*
- *Move to position height*
- *Move to position slat*
- *Scene 1 ... 64*

Automatic telegrams can be sent and received on the following output Group Objects:

- *Sun: Move to height*
- *Sun: Move slat*

Example

The travel range limit can be used to activate windows or skylights as well. The travel range for local operation by the room users is limited to 0 ... 20 %, whereas the complete range is available to the janitor.

12.2.3.5

Dead times



CAUTION – Malfunctions

Incorrect settings in the parameters can cause malfunctions.

- ▶ Observe the technical data of the connected drive.

Dead times can occur in the mechanism for sun protection systems due to the following factors:

- Aging processes, e.g. mechanical load
- Natural dead times during direction change
- Blind/Shutter opening from lower end position (100 %)
- Slat opening from the closed position (100 %)

These dead times can prevent the set positions from being reached precisely.

The following parameters are available to compensate for the dead times of the Blinds/Shutters and the slats:

- *Dead time Blind/Shutter movement from lower end position (100 %)*
- *Dead time slat movement (from 100 % closed)*
- *Dead time Blind/Shutter adjustment on change of direction*
- *Dead time slat adjustment on change of direction*

The "Blind/Shutter opening" dead time describes the time between the reception of the up command and the start of Blind/Shutter opening.

The "Slat opening" dead time describes the time between the reception of the open command and the start of slat opening.

The "Blind/slat adjustment" dead time describes the time between the reception of a direction changing movement command and the execution of the movement command.

The "Slat adjustment" dead time describes the time between the reception of a direction changing movement command and the execution of the movement command.

12.2.3.6

Tensioning/Slot positioning

Note

This function is available only if, in the parameter *Operating mode*, the option *Blind/Shutter control without slat adjustment* is selected.

This function can be set in the parameter *Tensioning/Slot positioning*. It is used to tauten or tension textile Blinds/Shutters (e.g. sheet of an articulated arm awning) or to adjust the slot position (e.g. light or ventilation slots) in slatted curtains. The Blind/Shutter is stopped at the end of a down movement and then moved in the opposite direction for the time set in the parameter *Duration for tensioning*.

If Tensioning/Slot positioning is active, it is triggered by the following movement telegrams:

- Direct telegrams (→ [Direct operation, Page 102](#))
- Automatic telegrams (→ [Function Automatic sun protection, Page 100](#))
- Manual operation (→ [Manual operation, Page 277](#))
- Safety telegrams (→ [Safety functions of Shutter Actuator, Page 88](#))

The following points must be taken into account:

- The movement telegrams must be present for longer than the set duration for Tensioning/Slot positioning.
- The duration of Tensioning/Slot positioning must be shorter than the total travel time for the down movement.
- In case of a movement telegram during active tensioning/slot positioning, a position value that is reduced by the duration of Tensioning/Slot positioning will be reported back.

The duration of Tensioning/Slot positioning influences the calculation of the Blind/Shutter position and the status Group Objects. The current Blind/Shutter position value is reported back to the device after Tensioning/Slot positioning.

Example

Calculation of the position value:

- Total down movement time: 60 s = 100 %
 - Duration of movement telegram: 30 s = 50 %
 - Duration of Tensioning/Slot positioning: 0.5 s = $(100 \% \times 0.5 \text{ s} / 60 \text{ s}) = 0.8 \%$
- Position value: 50 % – 0.8 % = 49.2 %

12.2.4 Coding, Group Object "Receive load shedding stage"

The information in the Group Object *Receive load shedding stage* is coded as follows:

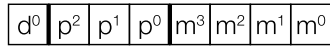

Fig. 60: Coding, data point type 236.001

The bit fields d and p contain information for the central load control.

Bit d⁰ activates or deactivates the central load control priority:

- 1 = Central load control priority is not active
- 0 = Central load control priority is active

The bits p² to p⁰ contain the central load control priorities. The bits must be set to 000, because the device only supports this priority.

The bits m³ to m⁰ contain the number of the load shedding stage (1 ... 15).

This produces the following coding:

- 1000mmmm or 00000000 = Load shedding stage not active
- 00000001 = Load shedding stage 1 (lowest priority)
- ...
- 00001111 = Load shedding stage 15 (highest priority)

All other values are not evaluated and discarded.

12.2.5 Coding, Group Object "Set load shedding stage"

The information in the Group Object *Set load shedding stage* is coded as follows:

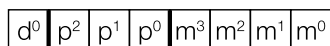

Fig. 61: Coding, data point type 236.001

The bit fields d and p contain information for the central load control. This information is not relevant for the device, the bits must be set to 0000.

The bits m³ to m⁰ contain the number of the load shedding stage (1 ... 15).

This produces the following coding:

- 00000001 = Set load shedding stage 1
- ...
- 00001111 = Set load shedding stage 15

All other values are not evaluated and discarded.

12.2.6 Ballast calculation

A ballast is used to operate gas-discharge lamps, e.g. fluorescent lamps. A ballast converts the mains voltage to the optimal operating voltage for the lamp and allows the lamp to strike (switch on). With the choke starter circuit, the lamps strike with a time offset, with the ballast circuit the lamps strike almost simultaneously.

For LED lamps the ballast is termed the LED driver or LED converter. The LED driver provides constant direct current or smoothed direct current for operating the lamps connected.

Input capacitors in the ballast's electronic circuit are required for storing charge to rectify and stabilize the alternating voltage or current on the primary side. The input capacitors charge at the moment of switch-on. The charging of the capacitors briefly generates a very high inrush current I_{peak} . If several ballasts are used in the same circuit, simultaneous charging of the capacitors can cause very high inrush currents to flow. The individual inrush currents must be taken into account in the design of the switching contacts and the selection of the back-up fuse. The inrush current is dependent on the ballast power, types and number of elements.

To determine the maximum number of ballasts that can be connected per output, the inrush current I_{peak} and the associated pulse width of the ballast must be known → Technical data for the ballast.

Typical values for the inrush current I_{peak} :

- Single-element ballast with T5/T8 fluorescent lamps: 15 ... 50 A, pulse time 120 ... 200 μs
- LED driver: 3 ... 50 A, pulse time 40 ... 250 μs

Refer to the related device's technical data for the maximum inrush current I_{peak} of the switching outputs → [Product overview, Page 11](#).

Example

Sample calculation for determining the maximum number of ballasts that can be connected per output:

- Ballast: ABB i-bus® KNX Ballast 1 x 58 CF, inrush current $I_{\text{peak}} = 33.9 \text{ A}$ (147.1 μs)
 - Maximum permissible inrush current I_{peak} of the output = 200 A (150 μs)
 - Calculation: $200 \text{ A} / 33.9 \text{ A} = 5.89$
- Result: Five ballasts can be connected per output.

12.2.7 Refreshed KNX state

If an input or an output is blocked by device-specific functions (e.g. manual operation, alarms, block, forced operation, switching delay), it will not react to telegrams received via the bus (ABB i-bus® KNX) while the block is active.

While a block is active, the device processes the telegrams received in the background. Active functions (e.g. staircase lighting, logic, position, brightness value) are executed in the background, but the results are not sent. The actual value is sent to the input or output when the block is canceled.

If the input or output has not received any telegrams via the bus (ABB i-bus® KNX) while a block is active, the input or output will assume the state it was in before the block.

12.2.8 Sending and switching delay

No telegrams are sent on the bus during the sending and switching delay (ABB i-bus® KNX).

Telegrams received (e.g. requests from a visualization system) are sent to the outputs after the sending and switching delay expires. The state of the outputs is set according to the settings in the ETS application or the telegram values of the Group Objects.

Time sequences (e.g. staircase lighting time) are started immediately during the sending and switching delay. If, at the time of reception, the staircase lighting time is smaller than the remaining sending and switching delay, the staircase lighting time elapses during the sending and switching delay. After the sending and switching delay has elapsed there is no switching command, the staircase lighting is not switched on.

Example

The delay time avoids unnecessary relay switching operations.

If an Off telegram is received during the sending and switching delay, the On telegram is overwritten and the relay is not switched.

Note

The sending and switching delay includes the device initialization time.

12.2.9 Telegram rate limit

The bus load generated by the device can be limited using the telegram rate limit. This limit relates to all telegrams sent by the device.

The device counts the number of telegrams sent within the parameterized period. As soon as the maximum number of sent telegrams is reached, no further telegrams are sent on the bus (ABB i-bus® KNX) until the end of the period. A new period commences automatically at the end of the previous period. The telegram counter is reset to zero. Telegrams can be sent again. The Group Object always sends the current telegram value.

The first period (break time) is not precisely predefined. The break time can be anywhere between 0 seconds and the parameterized period. The subsequent periods correspond to the parameterized time → parameter *In period (0 = deactivated)*.

Example

- Number of telegrams = 20
- Maximum number of telegrams per period = 5
- Period = 5 s

The device immediately sends 5 telegrams. The next 5 telegrams are sent after a maximum of 5 seconds. From this point, a further 5 telegrams are sent via the bus (ABB i-bus® KNX) every 5 seconds.

12.2.10 Value Read

Using the command "Value Read" the value of the state of a group address in a Group Object can be read. A Group Object can only reply if the "Read" flag is set. The group address first in the Group Object (sending group address) is always sent. The reply is only sent once and can only be understood by the Group Object that triggered the "Value Read" command. The value received is written to the reading Group Object.

12.2.11 Central Group Objects

The central Group Objects of the device can be used to switch several device outputs at the same time.

The following Group Object is available for central control of the Switch Actuator outputs:

- *Switch*

Note

In the parameter *Switch output reacts to central Switch Group Object*, it can be defined for each Switch Actuator output whether the output reacts to the central Group Object.

The following Group Objects are available for central activation of the Shutter Actuator output pairs:

- *Move Blind/Shutter Up/Down*
- *Slat adjustment / Stop Up/Down*
- *Move to position height*
- *Move to position slat*

Note

In the parameter *Output reacts to central shutter Group Objects*, it can be defined for each Shutter Actuator output pair whether the output pair reacts to the central Group Objects.

The following Group Object is available for central control of the Scenes:

- *Scene 1 ... 64*

12.2.12 Cyclical monitoring

The reception of a telegram on a Group Object can be monitored using the cyclical monitoring. If a telegram is not received on the Group Object within a parameterizable time (monitoring cycle), the sending device may be faulty or the bus cable to the sending device may be interrupted. The reaction to the loss of a telegram can be set in the application-specific parameters for the device.

After the receipt of a telegram, ETS download or bus voltage recovery, the monitoring cycle is restarted.

Note

The monitoring cycle in the device should be at least quadruple the cyclical sending time of the sending device. As a result, the reactions set will not be triggered immediately if a signal is missing, e.g. due to high bus load.

13 Appendix

13.1 Scope of delivery

The device is supplied together with the following components:

- 1x Switch/Shutter Actuator
- 1 x installation and operating instructions
- 1 x bus connection terminal (red/black)
- 1 x KNX connection cover cap

13.2 Table of values, Group Object "Status byte all active priorities" (Switch Actuator)

The following code table contains the telegram code of the Group Object *Status byte all active priorities* for a switching output.

All active priorities that affect the switching of the output are indicated in the status byte.

x = Value 1

Empty = Value 0

Bit no.	7	6	5	4	3	2	1	0	
8-bit value	Hexadecimal	i-bus® Tool	Load shedding	Safety priority 3	Safety priority 2	Safety priority 1	forced operation	Block	Manual operation
0	00								
1	01							x	
2	02						x		
3	03						x	x	
4	04					x			
5	05					x		x	
6	06					x	x		
7	07					x	x	x	
8	08				x				
9	09				x			x	
10	0A				x		x		
11	0B				x		x	x	
12	0C				x	x			
13	0D				x	x		x	
14	0E				x	x	x		
15	0F				x	x	x	x	
16	10			x					
17	11			x				x	
18	12			x			x		
19	13			x			x	x	
20	14			x		x			
21	15			x		x		x	
22	16			x		x	x		
23	17			x		x	x	x	
24	18			x	x				
25	19			x	x			x	
26	1A			x	x		x		
27	1B			x	x		x	x	
28	1C			x	x	x			
29	1D			x	x	x		x	
30	1E			x	x	x	x		
31	1F			x	x	x	x	x	
32	20		x						
33	21		x					x	
34	22		x				x		
35	23		x				x	x	
36	24		x			x			
37	25		x			x		x	
38	26		x			x	x		
39	27		x			x	x	x	
40	28		x		x				
41	29		x		x			x	
42	2A		x		x		x		
43	2B		x		x		x	x	
44	2C		x		x	x			
45	2D		x		x	x		x	
46	2E		x		x	x	x		
47	2F		x		x	x	x	x	
48	30		x	x					
49	31		x	x				x	
50	32		x	x			x		
51	33		x	x			x	x	
52	34		x	x		x			
53	35		x	x		x		x	
54	36		x	x		x	x		
55	37		x	x		x	x	x	
56	38		x	x	x				
57	39		x	x	x			x	
58	3A		x	x	x		x		
59	3B		x	x	x		x	x	
60	3C		x	x	x	x			
61	3D		x	x	x	x		x	

Bit no.	7	6	5	4	3	2	1	0	
8-bit value	Hexadecimal	i-bus® Tool	Load shedding	Safety priority 3	Safety priority 2	Safety priority 1	forced operation	Block	Manual operation
62	3E			x	x	x	x	x	
63	3F			x	x	x	x	x	
64	40		x						
65	41		x					x	
66	42		x					x	
67	43		x					x	
68	44		x				x		
69	45		x				x	x	
70	46		x				x	x	
71	47		x				x	x	
72	48		x		x				
73	49		x		x			x	
74	4A		x		x			x	
75	4B		x		x			x	
76	4C		x		x	x			
77	4D		x		x	x		x	
78	4E		x		x	x	x		
79	4F		x		x	x	x	x	
80	50		x		x				
81	51		x		x			x	
82	52		x		x			x	
83	53		x		x			x	
84	54		x		x		x		
85	55		x		x		x	x	
86	56		x		x		x	x	
87	57		x		x		x	x	
88	58		x		x	x			
89	59		x		x	x		x	
90	5A		x		x	x		x	
91	5B		x		x	x		x	
92	5C		x		x	x	x		
93	5D		x		x	x	x	x	
94	5E		x		x	x	x	x	
95	5F		x		x	x	x	x	
96	60		x	x					
97	61		x	x				x	
98	62		x	x				x	
99	63		x	x				x	
100	64		x	x			x		
101	65		x	x			x	x	
102	66		x	x			x	x	
103	67		x	x			x	x	
104	68		x	x		x			
105	69		x	x		x		x	
106	6A		x	x		x		x	
107	6B		x	x		x		x	
108	6C		x	x		x	x		
109	6D		x	x		x	x	x	
110	6E		x	x		x	x	x	
111	6F		x	x		x	x	x	
112	70		x	x	x				
113	71		x	x	x			x	
114	72		x	x	x			x	
115	73		x	x	x			x	
116	74		x	x	x		x		
117	75		x	x	x		x	x	
118	76		x	x	x		x	x	
119	77		x	x	x		x	x	
120	78		x	x	x	x			
121	79		x	x	x	x		x	
122	7A		x	x	x	x		x	
123	7B		x	x	x	x		x	

Bit no.		7	6	5	4	3	2	1	0
8-bit value	Hexadecimal	i-bus® Tool	Load shedding	Safety priority 3	Safety priority 2	Safety priority 1	forced operation	Block	Manual operation
124	7C		x	x	x	x	x		
125	7D		x	x	x	x	x		x
126	7E		x	x	x	x	x	x	
127	7F		x	x	x	x	x	x	x
128	80	x							
129	81	x							x
130	82	x						x	
131	83	x						x	x
132	84	x					x		
133	85	x					x		x
134	86	x					x	x	
135	87	x					x	x	x
136	88	x				x			
137	89	x				x			x
138	8A	x				x		x	
139	8B	x				x		x	x
140	8C	x				x	x		
141	8D	x				x	x		x
142	8E	x				x	x	x	
143	8F	x				x	x	x	x
144	90	x			x				
145	91	x			x				x
146	92	x			x			x	
147	93	x			x			x	x
148	94	x			x		x		
149	95	x			x		x		x
150	96	x			x		x	x	
151	97	x			x		x	x	x
152	98	x			x	x			
153	99	x			x	x			x
154	9A	x			x	x		x	
155	9B	x			x	x		x	x
156	9C	x			x	x	x		
157	9D	x			x	x	x		x
158	9E	x			x	x	x	x	
159	9F	x			x	x	x	x	x
160	A0	x		x					
161	A1	x		x					x
162	A2	x		x				x	
163	A3	x		x				x	x
164	A4	x		x			x		
165	A5	x		x			x		x
166	A6	x		x			x	x	
167	A7	x		x			x	x	x
168	A8	x		x		x			
169	A9	x		x		x			x
170	AA	x		x		x		x	
171	AB	x		x		x		x	x
172	AC	x		x		x	x		
173	AD	x		x		x	x		x
174	AE	x		x		x	x	x	
175	AF	x		x		x	x	x	x
176	B0	x		x	x				
177	B1	x		x	x				x
178	B2	x		x	x			x	
179	B3	x		x	x			x	x
180	B4	x		x	x		x		
181	B5	x		x	x		x		x
182	B6	x		x	x		x	x	
183	B7	x		x	x		x	x	x
184	B8	x		x	x	x			
185	B9	x		x	x	x			x
186	BA	x		x	x	x		x	
187	BB	x		x	x	x		x	x
188	BC	x		x	x	x	x		
189	BD	x		x	x	x	x		x

Bit no.		7	6	5	4	3	2	1	0
8-bit value	Hexadecimal	i-bus® Tool	Load shedding	Safety priority 3	Safety priority 2	Safety priority 1	forced operation	Block	Manual operation
190	BE	x		x	x	x	x	x	
191	BF	x		x	x	x	x	x	x
192	C0	x	x						
193	C1	x	x						x
194	C2	x	x					x	
195	C3	x	x					x	x
196	C4	x	x				x		
197	C5	x	x				x		x
198	C6	x	x				x	x	
199	C7	x	x				x	x	x
200	C8	x	x			x			
201	C9	x	x			x			x
202	CA	x	x			x		x	
203	CB	x	x			x		x	x
204	CC	x	x			x	x		
205	CD	x	x			x	x		x
206	CE	x	x			x	x	x	
207	CF	x	x			x	x	x	x
208	D0	x	x		x				
209	D1	x	x		x				x
210	D2	x	x		x			x	
211	D3	x	x		x			x	x
212	D4	x	x		x		x		
213	D5	x	x		x		x		x
214	D6	x	x		x		x	x	
215	D7	x	x		x		x	x	x
216	D8	x	x		x	x			
217	D9	x	x		x	x			x
218	DA	x	x		x	x		x	
219	DB	x	x		x	x		x	x
220	DC	x	x		x	x	x		
221	DD	x	x		x	x	x		x
222	DE	x	x		x	x	x	x	
223	DF	x	x		x	x	x	x	x
224	E0	x	x	x					
225	E1	x	x	x					x
226	E2	x	x	x				x	
227	E3	x	x	x				x	x
228	E4	x	x	x			x		
229	E5	x	x	x			x		x
230	E6	x	x	x			x	x	
231	E7	x	x	x			x	x	x
232	E8	x	x	x		x			
233	E9	x	x	x		x			x
234	EA	x	x	x		x		x	
235	EB	x	x	x		x		x	x
236	EC	x	x	x		x	x		
237	ED	x	x	x		x	x		x
238	EE	x	x	x		x	x	x	
239	EF	x	x	x		x	x	x	x
240	F0	x	x	x	x				
241	F1	x	x	x	x				x
242	F2	x	x	x	x			x	
243	F3	x	x	x	x			x	x
244	F4	x	x	x	x		x		
245	F5	x	x	x	x		x		x
246	F6	x	x	x	x		x	x	
247	F7	x	x	x	x		x	x	x
248	F8	x	x	x	x	x			
249	F9	x	x	x	x	x			x
250	FA	x	x	x	x	x		x	
251	FB	x	x	x	x	x		x	x
252	FC	x	x	x	x	x	x		
253	FD	x	x	x	x	x	x		x
254	FE	x	x	x	x	x	x	x	
255	FF	x	x	x	x	x	x	x	x

Tab. 72: Table of values, Group Object "Status information" (switching output)

13.3 Table of values, Group Object "Status byte all active priorities" (Shutter Actuator)

The following code table contains the telegram code of the Group Object *Status byte all active priorities* for a blind output.

All active priorities that affect the switching of the output are indicated in the status byte.

x = Value 1

Empty = Value 0

Bit no.		7	6	5	4	3	2	1	0
8-bit value	Hexadecimal	i-bus® Tool	Automatic sun protection	Wind alarm	Rain alarm	Frost alarm	forced operation	Block	Manual operation
0	00								
1	01								x
2	02							x	
3	03							x	x
4	04						x		
5	05						x		x
6	06						x	x	
7	07						x	x	x
8	08					x			
9	09					x			x
10	0A					x		x	
11	0B					x		x	x
12	0C					x	x		
13	0D					x	x		x
14	0E					x	x	x	
15	0F					x	x	x	x
16	10				x				
17	11				x				x
18	12				x			x	
19	13				x			x	x
20	14				x		x		
21	15				x		x		x
22	16				x		x	x	
23	17				x		x	x	x
24	18				x	x			
25	19				x	x			x
26	1A				x	x		x	
27	1B				x	x		x	x
28	1C				x	x	x		
29	1D				x	x	x		x
30	1E				x	x	x	x	
31	1F				x	x	x	x	x
32	20			x					
33	21			x					x
34	22			x				x	
35	23			x				x	x
36	24			x			x		
37	25			x			x		x
38	26			x			x	x	
39	27			x			x	x	x
40	28			x		x			
41	29			x		x			x
42	2A			x		x		x	
43	2B			x		x		x	x
44	2C			x		x	x		
45	2D			x		x	x		x
46	2E			x		x	x	x	
47	2F			x		x	x	x	x
48	30			x	x				
49	31			x	x				x
50	32			x	x			x	
51	33			x	x			x	x
52	34			x	x		x		
53	35			x	x		x		x
54	36			x	x		x	x	
55	37			x	x		x	x	x
56	38			x	x	x			
57	39			x	x	x			x
58	3A			x	x	x		x	
59	3B			x	x	x		x	x
60	3C			x	x	x	x		
61	3D			x	x	x	x		x

Bit no.		7	6	5	4	3	2	1	0
8-bit value	Hexadecimal	i-bus® Tool	Automatic sun protection	Wind alarm	Rain alarm	Frost alarm	forced operation	Block	Manual operation
62	3E			x	x	x	x	x	
63	3F			x	x	x	x	x	x
64	40		x						
65	41		x						x
66	42		x					x	
67	43		x					x	x
68	44		x				x		
69	45		x				x		x
70	46		x				x	x	
71	47		x				x	x	x
72	48		x			x			
73	49		x			x			x
74	4A		x			x		x	
75	4B		x			x		x	x
76	4C		x			x	x		
77	4D		x			x	x		x
78	4E		x			x	x	x	
79	4F		x			x	x	x	x
80	50		x		x				
81	51		x		x				x
82	52		x		x			x	
83	53		x		x			x	x
84	54		x		x		x		
85	55		x		x		x		x
86	56		x		x		x	x	
87	57		x		x		x	x	x
88	58		x		x	x			
89	59		x		x	x			x
90	5A		x		x	x		x	
91	5B		x		x	x		x	x
92	5C		x		x	x	x		
93	5D		x		x	x	x		x
94	5E		x		x	x	x	x	
95	5F		x		x	x	x	x	x
96	60		x	x					
97	61		x	x					x
98	62		x	x				x	
99	63		x	x				x	x
100	64		x	x			x		
101	65		x	x			x		x
102	66		x	x			x	x	
103	67		x	x			x	x	x
104	68		x	x		x			
105	69		x	x		x			x
106	6A		x	x		x		x	
107	6B		x	x		x		x	x
108	6C		x	x		x	x		
109	6D		x	x		x	x		x
110	6E		x	x		x	x	x	
111	6F		x	x		x	x	x	x
112	70		x	x	x				
113	71		x	x	x				x
114	72		x	x	x			x	
115	73		x	x	x			x	x
116	74		x	x	x		x		
117	75		x	x	x		x		x
118	76		x	x	x		x	x	
119	77		x	x	x		x	x	x
120	78		x	x	x	x			
121	79		x	x	x	x			x
122	7A		x	x	x	x		x	
123	7B		x	x	x	x		x	x

Bit no.		7	6	5	4	3	2	1	0
8-bit value	Hexadecimal	i-bus® Tool	Automatic sun protection	Wind alarm	Rain alarm	Frost alarm	forced operation	Block	Manual operation
124	7C		x	x	x	x	x		
125	7D		x	x	x	x	x		x
126	7E		x	x	x	x	x	x	
127	7F		x	x	x	x	x	x	x
128	80	x							
129	81	x							x
130	82	x						x	
131	83	x						x	x
132	84	x					x		
133	85	x					x		x
134	86	x					x	x	
135	87	x					x	x	x
136	88	x				x			
137	89	x				x			x
138	8A	x				x		x	
139	8B	x				x		x	x
140	8C	x				x	x		
141	8D	x				x	x		x
142	8E	x				x	x	x	
143	8F	x				x	x	x	x
144	90	x			x				
145	91	x			x				x
146	92	x			x			x	
147	93	x			x			x	x
148	94	x			x		x		
149	95	x			x		x		x
150	96	x			x		x	x	
151	97	x			x		x	x	x
152	98	x			x	x			
153	99	x			x	x			x
154	9A	x			x	x		x	
155	9B	x			x	x		x	x
156	9C	x			x	x	x		
157	9D	x			x	x	x		x
158	9E	x			x	x	x	x	
159	9F	x			x	x	x	x	x
160	A0	x		x					
161	A1	x		x					x
162	A2	x		x				x	
163	A3	x		x				x	x
164	A4	x		x			x		
165	A5	x		x			x		x
166	A6	x		x			x	x	
167	A7	x		x			x	x	x
168	A8	x		x		x			
169	A9	x		x		x			x
170	AA	x		x		x		x	
171	AB	x		x		x		x	x
172	AC	x		x		x	x		
173	AD	x		x		x	x		x
174	AE	x		x		x	x	x	
175	AF	x		x		x	x	x	x
176	B0	x		x	x				
177	B1	x		x	x				x
178	B2	x		x	x			x	
179	B3	x		x	x			x	x
180	B4	x		x	x		x		
181	B5	x		x	x		x		x
182	B6	x		x	x		x	x	
183	B7	x		x	x		x	x	x
184	B8	x		x	x	x			
185	B9	x		x	x	x			x
186	BA	x		x	x	x		x	
187	BB	x		x	x	x		x	x
188	BC	x		x	x	x	x		
189	BD	x		x	x	x	x		x

Bit no.		7	6	5	4	3	2	1	0
8-bit value	Hexadecimal	i-bus® Tool	Automatic sun protection	Wind alarm	Rain alarm	Frost alarm	forced operation	Block	Manual operation
190	BE	x		x	x	x	x	x	
191	BF	x		x	x	x	x	x	x
192	C0	x	x						
193	C1	x	x						x
194	C2	x	x					x	
195	C3	x	x					x	x
196	C4	x	x				x		
197	C5	x	x				x		x
198	C6	x	x				x	x	
199	C7	x	x				x	x	x
200	C8	x	x			x			
201	C9	x	x			x			x
202	CA	x	x			x		x	
203	CB	x	x			x		x	x
204	CC	x	x			x	x		
205	CD	x	x			x	x		x
206	CE	x	x			x	x	x	
207	CF	x	x			x	x	x	x
208	D0	x	x		x				
209	D1	x	x		x				x
210	D2	x	x		x			x	
211	D3	x	x		x			x	x
212	D4	x	x		x		x		
213	D5	x	x		x		x		x
214	D6	x	x		x		x	x	
215	D7	x	x		x		x	x	x
216	D8	x	x		x	x			
217	D9	x	x		x	x			x
218	DA	x	x		x	x		x	
219	DB	x	x		x	x		x	x
220	DC	x	x		x	x	x		
221	DD	x	x		x	x	x		x
222	DE	x	x		x	x	x	x	
223	DF	x	x		x	x	x	x	x
224	E0	x	x	x					
225	E1	x	x	x					x
226	E2	x	x	x				x	
227	E3	x	x	x				x	x
228	E4	x	x	x			x		
229	E5	x	x	x			x		x
230	E6	x	x	x			x	x	
231	E7	x	x	x			x	x	x
232	E8	x	x	x		x			
233	E9	x	x	x		x			x
234	EA	x	x	x		x		x	
235	EB	x	x	x		x		x	x
236	EC	x	x	x		x	x		
237	ED	x	x	x		x	x		x
238	EE	x	x	x		x	x	x	
239	EF	x	x	x		x	x	x	x
240	F0	x	x	x	x				
241	F1	x	x	x	x				x
242	F2	x	x	x	x			x	
243	F3	x	x	x	x			x	x
244	F4	x	x	x	x		x		
245	F5	x	x	x	x		x		x
246	F6	x	x	x	x		x	x	
247	F7	x	x	x	x		x	x	x
248	F8	x	x	x	x	x			
249	F9	x	x	x	x	x			x
250	FA	x	x	x	x	x		x	
251	FB	x	x	x	x	x		x	x
252	FC	x	x	x	x	x	x		
253	FD	x	x	x	x	x	x		x
254	FE	x	x	x	x	x	x	x	
255	FF	x	x	x	x	x	x	x	x

Tab. 73: Table of values, Group Object "Status information" (blind output)

13.4 Table of values, Group Object "Scene 1 ... 64"

The following table contains the telegram code of the 64 Scenes. Each 8-bit Scene is indicated in hexadecimal and binary codes. The 8-bit value is sent when a Scene is recalled/stored.

x = Value 1

Empty = Value 0

Bit no.	7	6	5	4	3	2	1	0		
8-bit value	Hexadecimal	Recall/store	Not defined	Binary number codes	Binary number codes	Binary number codes	Binary number codes	Binary number codes	Scene number	Recall A Store S No reaction -
0	00								1	A
1	01							x	2	A
2	02						x		3	A
3	03						x	x	4	A
4	04					x			5	A
5	05					x		x	6	A
6	06					x	x		7	A
7	07					x	x	x	8	A
8	08				x				9	A
9	09				x			x	10	A
10	0A				x		x		11	A
11	0B				x		x	x	12	A
12	0C				x	x			13	A
13	0D				x	x		x	14	A
14	0E				x	x	x		15	A
15	0F				x	x	x	x	16	A
16	10			x					17	A
17	11			x				x	18	A
18	12			x			x		19	A
19	13			x			x	x	20	A
20	14			x		x			21	A
21	15			x		x		x	22	A
22	16			x		x	x		23	A
23	17			x		x	x	x	24	A
24	18			x	x				25	A
25	19			x	x			x	26	A
26	1A			x	x		x		27	A
27	1B			x	x		x	x	28	A
28	1C			x	x	x			29	A
29	1D			x	x	x		x	30	A
30	1E			x	x	x	x		31	A
31	1F			x	x	x	x	x	32	A
32	20			x					33	A
33	21			x				x	34	A
34	22			x				x	35	A
35	23			x			x	x	36	A
36	24			x		x			37	A
37	25			x		x		x	38	A
38	26			x		x	x		39	A
39	27			x		x	x	x	40	A
40	28			x		x			41	A
41	29			x		x		x	42	A
42	2A			x		x		x	43	A
43	2B			x		x		x	44	A
44	2C			x		x	x		45	A
45	2D			x		x	x	x	46	A
46	2E			x		x	x	x	47	A
47	2F			x		x	x	x	48	A
48	30			x	x				49	A
49	31			x	x			x	50	A
50	32			x	x			x	51	A
51	33			x	x			x	52	A
52	34			x	x			x	53	A
53	35			x	x			x	54	A
54	36			x	x			x	55	A
55	37			x	x			x	56	A
56	38			x	x			x	57	A
57	39			x	x			x	58	A
58	3A			x	x			x	59	A
59	3B			x	x			x	60	A
60	3C			x	x			x	61	A
61	3D			x	x			x	62	A
62	3E			x	x			x	63	A

Bit no.	7	6	5	4	3	2	1	0		
8-bit value	Hexadecimal	Recall/store	Not defined	Binary number codes	Binary number codes	Binary number codes	Binary number codes	Binary number codes	Scene number	Recall A Store S No reaction -
63	3F			x	x	x	x	x	64	A
64	40		x						-	-
65	41		x					x	-	-
66	42		x				x		-	-
67	43		x				x	x	-	-
68	44		x			x			-	-
69	45		x			x		x	-	-
70	46		x			x	x		-	-
71	47		x			x	x	x	-	-
72	48		x			x			-	-
73	49		x			x		x	-	-
74	4A		x			x		x	-	-
75	4B		x			x		x	-	-
76	4C		x			x	x		-	-
77	4D		x			x	x	x	-	-
78	4E		x			x	x	x	-	-
79	4F		x			x	x	x	-	-
80	50		x		x				-	-
81	51		x		x			x	-	-
82	52		x		x			x	-	-
83	53		x		x			x	-	-
84	54		x		x			x	-	-
85	55		x		x			x	-	-
86	56		x		x			x	-	-
87	57		x		x			x	-	-
88	58		x		x		x		-	-
89	59		x		x			x	-	-
90	5A		x		x			x	-	-
91	5B		x		x			x	-	-
92	5C		x		x			x	-	-
93	5D		x		x			x	-	-
94	5E		x		x			x	-	-
95	5F		x		x			x	-	-
96	60		x		x				-	-
97	61		x		x			x	-	-
98	62		x		x			x	-	-
99	63		x		x			x	-	-
100	64		x		x			x	-	-
101	65		x		x			x	-	-
102	66		x		x			x	-	-
103	67		x		x			x	-	-
104	68		x		x			x	-	-
105	69		x		x			x	-	-
106	6A		x		x			x	-	-
107	6B		x		x			x	-	-
108	6C		x		x			x	-	-
109	6D		x		x			x	-	-
110	6E		x		x			x	-	-
111	6F		x		x			x	-	-
112	70		x		x			x	-	-
113	71		x		x			x	-	-
114	72		x		x			x	-	-
115	73		x		x			x	-	-
116	74		x		x			x	-	-
117	75		x		x			x	-	-
118	76		x		x			x	-	-
119	77		x		x			x	-	-
120	78		x		x			x	-	-
121	79		x		x			x	-	-
122	7A		x		x			x	-	-
123	7B		x		x			x	-	-
124	7C		x		x			x	-	-
125	7D		x		x			x	-	-

Bit no.	7	6	5	4	3	2	1	0		
8-bit value	Hexadecimal	Recall/store	Not defined	Binary number codes	Binary number codes	Binary number codes	Binary number codes	Binary number codes	Scene number	Recall A Store S No reaction –
126	7E		x	x	x	x	x	x	-	-
127	7F		x	x	x	x	x	x	-	-
128	80	x							1	S
129	81	x						x	2	S
130	82	x						x	3	S
131	83	x						x	4	S
132	84	x					x		5	S
133	85	x				x		x	6	S
134	86	x				x	x		7	S
135	87	x				x	x	x	8	S
136	88	x			x				9	S
137	89	x			x			x	10	S
138	8A	x			x		x		11	S
139	8B	x			x		x	x	12	S
140	8C	x			x	x			13	S
141	8D	x			x	x		x	14	S
142	8E	x			x	x	x		15	S
143	8F	x			x	x	x	x	16	S
144	90	x			x				17	S
145	91	x			x			x	18	S
146	92	x			x			x	19	S
147	93	x			x			x	20	S
148	94	x			x		x		21	S
149	95	x			x	x		x	22	S
150	96	x			x		x	x	23	S
151	97	x			x		x	x	24	S
152	98	x			x	x			25	S
153	99	x			x	x		x	26	S
154	9A	x			x	x		x	27	S
155	9B	x			x	x		x	28	S
156	9C	x			x	x	x		29	S
157	9D	x			x	x	x	x	30	S
158	9E	x			x	x	x	x	31	S
159	9F	x			x	x	x	x	32	S
160	A0	x			x				33	S
161	A1	x			x			x	34	S
162	A2	x			x			x	35	S
163	A3	x			x			x	36	S
164	A4	x			x			x	37	S
165	A5	x			x			x	38	S
166	A6	x			x			x	39	S
167	A7	x			x			x	40	S
168	A8	x			x				41	S
169	A9	x			x			x	42	S
170	AA	x			x			x	43	S
171	AB	x			x			x	44	S
172	AC	x			x			x	45	S
173	AD	x			x			x	46	S
174	AE	x			x			x	47	S
175	AF	x			x			x	48	S
176	B0	x			x	x			49	S
177	B1	x			x	x			50	S
178	B2	x			x	x		x	51	S
179	B3	x			x	x		x	52	S
180	B4	x			x	x		x	53	S
181	B5	x			x	x		x	54	S
182	B6	x			x	x		x	55	S
183	B7	x			x	x		x	56	S
184	B8	x			x	x		x	57	S
185	B9	x			x	x		x	58	S
186	BA	x			x	x		x	59	S
187	BB	x			x	x		x	60	S
188	BC	x			x	x		x	61	S
189	BD	x			x	x		x	62	S
190	BE	x			x	x		x	63	S

Tab. 74: Code table 8-bit Scene

Bit no.	7	6	5	4	3	2	1	0		
8-bit value	Hexadecimal	Recall/store	Not defined	Binary number codes	Binary number codes	Binary number codes	Binary number codes	Binary number codes	Scene number	Recall A Store S No reaction –
191	BF	x		x	x		x	x	64	S
192	C0	x	x						-	-
193	C1	x	x						-	-
194	C2	x	x					x	-	-
195	C3	x	x					x	-	-
196	C4	x	x				x		-	-
197	C5	x	x				x		-	-
198	C6	x	x				x	x	-	-
199	C7	x	x				x	x	-	-
200	C8	x	x				x		-	-
201	C9	x	x				x		-	-
202	CA	x	x				x	x	-	-
203	CB	x	x				x	x	-	-
204	CC	x	x				x	x	-	-
205	CD	x	x				x	x	-	-
206	CE	x	x				x	x	-	-
207	CF	x	x				x	x	-	-
208	D0	x	x			x			-	-
209	D1	x	x			x			-	-
210	D2	x	x			x		x	-	-
211	D3	x	x			x		x	-	-
212	D4	x	x			x		x	-	-
213	D5	x	x			x		x	-	-
214	D6	x	x			x		x	-	-
215	D7	x	x			x		x	-	-
216	D8	x	x			x		x	-	-
217	D9	x	x			x		x	-	-
218	DA	x	x			x		x	-	-
219	DB	x	x			x		x	-	-
220	DC	x	x			x		x	-	-
221	DD	x	x			x		x	-	-
222	DE	x	x			x		x	-	-
223	DF	x	x			x		x	-	-
224	E0	x	x			x			-	-
225	E1	x	x			x			-	-
226	E2	x	x			x			-	-
227	E3	x	x			x			-	-
228	E4	x	x			x			-	-
229	E5	x	x			x			-	-
230	E6	x	x			x			-	-
231	E7	x	x			x			-	-
232	E8	x	x			x			-	-
233	E9	x	x			x			-	-
234	EA	x	x			x			-	-
235	EB	x	x			x			-	-
236	EC	x	x			x			-	-
237	ED	x	x			x			-	-
238	EE	x	x			x			-	-
239	EF	x	x			x			-	-
240	F0	x	x			x			-	-
241	F1	x	x			x			-	-
242	F2	x	x			x			-	-
243	F3	x	x			x			-	-
244	F4	x	x			x			-	-
245	F5	x	x			x			-	-
246	F6	x	x			x			-	-
247	F7	x	x			x			-	-
248	F8	x	x			x			-	-
249	F9	x	x			x			-	-
250	FA	x	x			x			-	-
251	FB	x	x			x			-	-
252	FC	x	x			x			-	-
253	FD	x	x			x			-	-
254	FE	x	x			x			-	-
255	FF	x	x			x			-	-



ABB STOTZ-KONTAKT GmbH

Eppelheimer Straße 82

69123 Heidelberg, Germany

Tel.: +49 (0)6221 701 607

Fax: +49 (0)6221 701 724

Email: knx.marketing@de.abb.com

**Additional information and regional
points of contact:**

www.abb.de/knx

www.abb.com/knx

© Copyright 2022 ABB. We reserve the right to make technical changes to the products as well as amendments to the content of this document at any time without advance notice. The agreed properties are definitive for any orders placed. ABB AG does not accept any responsibility whatsoever for potential errors or possible lack of information in this document. We reserve all rights in this document and in the subject matter and illustrations contained therein. Reproduction, transfer to third parties or processing of the content – including sections thereof – is not permitted without the prior written consent of ABB AG.

