



ABB i-bus[®] KNX Analogue Actuator AA/S 4.1.2, AA/A 2.1.2 Product Manual

Contents

Page

1	General	3
1.1	Using the product manual.....	3
1.1.1	Notes	4
1.2	Product and functional overview.....	5
1.2.1	Integration in the i-bus [®] Tool	6
2	Device technology	7
2.1	AA/S 4.1.2 Analogue Actuator, 4-fold, MDRC	7
2.1.1	Technical data	7
2.1.2	Connection diagram	9
2.1.3	Dimension drawing	10
2.2	AA/A 2.1.2 Analogue Actuator, 2-fold, SM.....	11
2.2.1	Technical data	11
2.2.2	Connection diagram	13
2.2.3	Dimension drawing.....	14
2.3	Mounting and installation	15
2.4	Display elements	17
3	Commissioning.....	19
3.1	Overview.....	19
3.2	Parameters	20
3.2.1	Parameter window <i>General</i>	21
3.2.2	Parameter window <i>A: General</i>	26
3.2.3	Parameter window <i>A: Characteristic</i>	35
3.2.4	Parameter window <i>A: Dimming</i>	41
3.2.5	Parameter window <i>A: Scenes</i>	43
3.2.6	Parameter window <i>A: Forced operation</i>	45
3.3	Group objects	50
3.3.1	Summary of group objects.....	50
3.3.2	Input objects	52
3.3.2.1	Group objects General	52
3.3.2.2	Group objects Channel A.....	52
3.3.2.3	Group objects Channel B, C and D	54
3.3.3	Output objects	55
3.3.3.1	Group objects General	55
3.3.3.2	Group objects Channel A.....	57
3.3.3.3	Group objects Channel B, C and D	58
A	Appendix	59
A.1	Scope of delivery	59
A.2	Value table of group object <i>Status byte channel A/B</i>	60
A.3	Value table of group object <i>Status byte channel C/D</i>	61
A.4	Ordering details	62

1 General

The Analogue Actuator converts telegrams received via KNX into analog output signals. These signals allow terminal devices in the heating, air-conditioning and ventilation technology or lighting technology to adapt their output variables using bus information and participate in control processes.

1.1 Using the product manual

This manual provides detailed technical information on the function, installation and programming of the ABB i-bus[®] KNX device. The application is explained using examples.

This manual is divided into the following chapters:

Chapter 1	General
Chapter 2	Device technology
Chapter 3	Commissioning
Chapter A	Appendix

1.1.1

Notes

Notes and safety instructions are represented as follows in this manual:

Note
Tips for usage and operation

Examples
Application examples, installation examples, programming examples

Important
These safety instructions are used as soon as there is danger of a malfunction without risk of damage or injury.

Attention
These safety instructions are used as soon as there is danger of a malfunction without risk of damage or injury.

 Danger
These safety instructions are used if there is a danger to life and limb with inappropriate use.

  Danger
These safety instructions are used if there is an extreme danger to life with inappropriate use.

1.2 Product and functional overview

The Analogue Actuator has four or two analog outputs, which can be defined as voltage or current outputs (not applicable to AA/A) and can be parameterized in one of the following formats using software. Outputs that are not required can be deactivated.

In the process, various signal outputs are pre-configured to react (respond) in a particular way.

Voltage signals:

Output	Reaction	Application
0...1 V	No special reaction	Control signal, e.g. in HVAC
0...5 V	No special reaction	Control signal
0...10 V	No special reaction	Control signal; most frequently used control signal in HVAC
1...10 V	Can be used to actuate ballasts of up to 1 mA	Control signal often used in lighting

Current signals (not applicable to AA/A):

Output	Reaction	Application
0...20 mA	No special reaction	Control signal
4...20 mA	No special reaction	Supply control signal for active parts

The output variables can be forcibly operated by a higher-level control system.

In addition, specific processes can be predefined for the outputs using the function *Characteristic*.

Each channel can be assigned up to 16 scenes.

Note
Analogue Actuator AA/S requires an external 100...240 V AC 50/60 Hz power supply. Analogue Actuator AA/A requires no auxiliary voltage.

1.2.1 Integration in the i-bus[®] Tool

The device possesses an interface to the i-bus[®] Tool.

The i-bus[®] Tool can be used to change settings on the connected device.

The i-bus[®] Tool can be downloaded for free from our website (www.abb.com/knx).

A description of the functions can be found in the i-bus[®] Tool online help.

2 Device technology

2.1 AA/S 4.1.2 Analogue Actuator, 4-fold, MDRC



2CDC071004S0016

Analogue Actuator AA/S 4.1.2

The Analogue Actuator converts telegrams received via KNX into analog output signals. The device has four outputs. The analog outputs can be used independently of one another as current or voltage outputs with adjustable output signals.

The Analogue Actuator is a modular installation device for installation in the distribution board. It connects to the KNX via a bus connection terminal. The device requires an external 100...240 V AC auxiliary voltage. The device is parameterized and programmed using ETS.

2.1.1 Technical data

Supply	Auxiliary voltage	100...240 V AC +10 %/-15 %, 50/60 Hz
	Power supply	Via ABB i-bus KNX
	KNX current consumption	Max. 12 mA
	KNX power loss	Max. 250 mW
	Power loss P	0.8 W
Analog outputs	4, A...D	
	Voltage signals	0...1 V DC
		0...5 V DC
		0...10 V DC
		1...10 V DC
Current signal	0...20 mA DC	
	4...20 mA DC	
Output signal load	Depending on parameterization	
	Voltage signal:	≥ 1 kohm
	Current signal:	≤ 500 ohms
Output current	Voltage signal	Max. 10 mA per channel
	For 1...10 V output and ballasts	Max. 1 mA per channel
	Current signal	Max. 20 mA per channel
Operating and display elements	<i>Programming</i> button/LED (red)	For assignment of the physical address
	A...D <i>status</i> LED (yellow)	Channel A...D status display
	KNX <i>status</i> LED (green)	KNX status display
	<i>Power</i> LED (green)	Auxiliary voltage display
Connections	KNX connection	Bus connection terminal, screwless
	Analogue outputs A...D	Screw terminals
	Tightening torque	0.2...4.0 mm ² rigid/flexible with/without ferrules 0.2...4.0 mm ² solid-core Max. 0.6 Nm
Degree of protection	IP 20	To DIN EN 60 529
Protection class	II	To DIN EN 61 140
Isolation category	Overvoltage category	III to DIN EN 60 664-1
	Pollution degree	II to DIN EN 60 664-1
KNX safety voltage	SELV 24 V DC	

ABB i-bus® KNX

Device technology

Temperature range	Operation	-5 °C...+45 °C
	Storage	-25...+55 °C
	Transport	-25...+70 °C
Ambient conditions	Maximum air humidity	93 %, no condensation allowed
	Atmospheric pressure	Atmosphere up to 2,000 m
Design	Modular installation device (MDRC)	Modular installation device, Pro M
	Dimensions	90 x 70 x 64.5 mm (H x W x D)
	Mounting width in space units	4x 18 mm modules
	Mounting depth	70 mm
Mounting	On 35 mm mounting rail	To DIN EN 60 715
Mounting position	Any	
Weight	0.17 kg	
Housing/color	Plastic housing, gray	
Approvals	KNX to EN 50 090-1, -2	Certification
CE mark	In accordance with the EMC guideline and low voltage guideline	

Device type	Application	Max. number of group objects	Max. number of group addresses	Max. number of assignments
AA/S 4.1.2	Analog output 4f/*	57	254	254

* ... = Current version number of the application. **Please refer to the software information on our website for this purpose.**

Note

ETS and the current version of the device application are required for programming. The current application and corresponding software information can be downloaded at www.abb.com/knx. After import into ETS, it appears in the *Catalogs* window under *Manufacturers/ABB/Output/Analog Output*.

The device does not support the locking function of a KNX device in ETS. If you use a *BCU code* to inhibit access to all the project devices, this has no effect on this device. Data can still be read and programmed.

ABB i-bus® KNX Device technology

2.1.2 Connection diagram

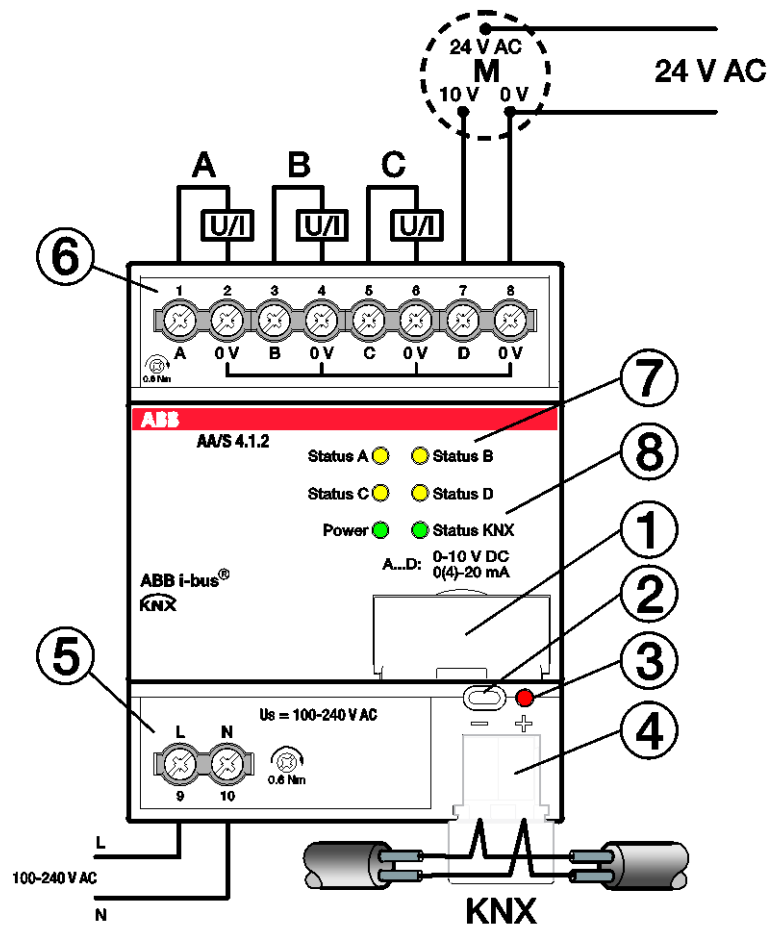

2CDC072017F0016

- 1 Label carrier
- 2 Programming button
- 3 Programming LED (red)
- 4 Bus connection terminal
- 5 Power supply connection U_s
- 6 Analog output A
- 7 Channels A...D status LED (yellow)
- 8 Device status LED (green)

2.1.3

Dimension drawing

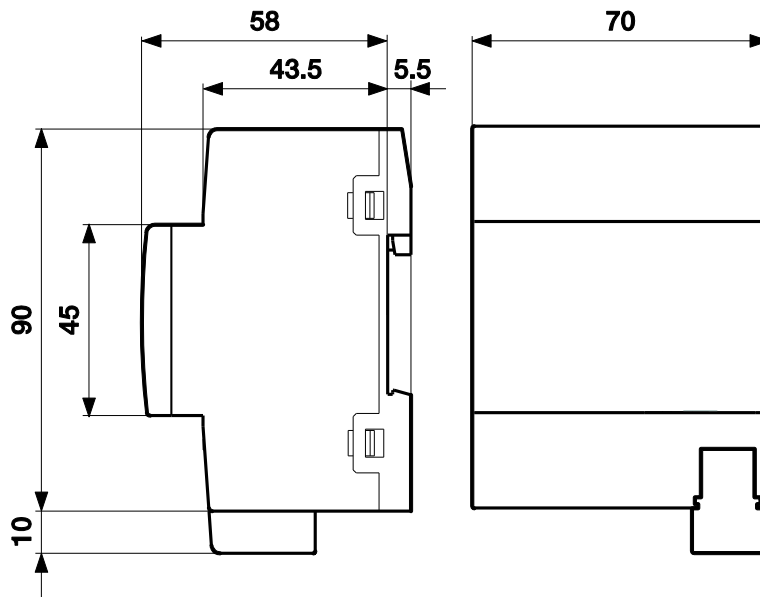

2CDC072033F0015

2.2 AA/A 2.1.2 Analogue Actuator, 2-fold, SM



2CDC071003S0016

Analogue Actuator AA/A 2.1.2

The Analogue Actuator converts telegrams received via KNX into analog output signals. The device has two outputs. The analog outputs can be used independently of one another as voltage outputs with adjustable output signals.

The Analogue Actuator is a surface mounted device. It connects to the KNX via a bus connection terminal. The device is parameterized and programmed using ETS. It is powered by the KNX bus.

2.2.1 Technical data

Supply	Power supply	Via ABB i-bus KNX
	KNX current consumption	Max. 12 mA
	KNX power loss	Max. 250 mW
	Power loss P	250 mW
Analogue outputs	2, A...B	
	Voltage signals	0...1 V DC 0...5 V DC 0...10 V DC 1...10 V DC Depending on parameterization
	Output signal load	Voltage signal: ≥ 5 kohms
Output current	Voltage signal	Max. 2 mA per channel
	For 1...10 V output and ballasts	Max. 4 mA per Channel
Operating and display elements	<i>Programming</i> button/LED (red)	For assignment of the physical address
Connections	KNX connection	Pluggable screw terminal, green
	Analogue outputs A...B	Pluggable screw terminals, green 0.08...1.5 mm ² rigid/flexible with/without ferrules without plastic sleeves
	Cable entry	4x, individual
	Stripping length	7 mm
	Screw thread	M2
	Tightening torque	Max. 0.25 Nm
Degree of protection	IP 54	To DIN EN 60 529
Protection class	II	To DIN EN 61 140
Isolation category	Overvoltage category	III to DIN EN 60 664-1
	Pollution degree	II to DIN EN 60 664-1
KNX safety voltage	SELV 24 V DC	

ABB i-bus[®] KNX

Device technology

Temperature range	Operation	-20...+70 °C
	Storage	-25...+70 °C
	Transport	-25...+70 °C
Ambient conditions	Maximum air humidity	93 %, no condensation allowed
	Atmospheric pressure	Atmosphere up to 2,000 m
Design	Dimensions	117 x 117 x 51 mm (H x W x D)
Mounting	Surface mounted device, screw fixing	
Mounting position	Any	
Weight	0.25 kg	
Approvals	KNX to EN 50 090-1, -2	Certification
CE mark	In accordance with the EMC guideline and low voltage guideline	

Device type	Application	Max. number of group objects	Max. number of group addresses	Max. number of assignments
AA/A 2.1.2	Analog output 2f/*	29	254	254

* ... = Current version number of the application. **Please refer to the software information on our website for this purpose.**

Note

ETS and the current version of the device application are required for programming. The current application and corresponding software information can be downloaded at www.abb.com/knx. After import into ETS, it appears in the *Catalogs* window under *Manufacturers/ABB/Output/Analog Output*.

The device does not support the locking function of a KNX device in ETS. If you use a *BCU code* to inhibit access to all the project devices, this has no effect on this device. Data can still be read and programmed.

2.2.2 Connection diagram

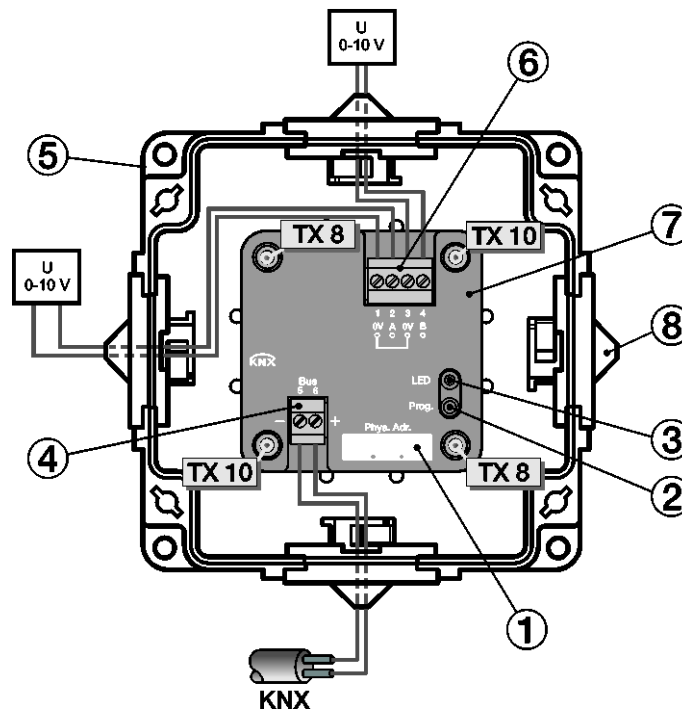

2CDC072040F0015

- 1 Label carrier
- 2 Programming button
- 3 Programming LED (red)
- 4 KNX bus connection
- 5 Housing
- 6 Analog outputs
- 7 Device cover
- 8 4 x cable entry

2.2.3 Dimension drawing

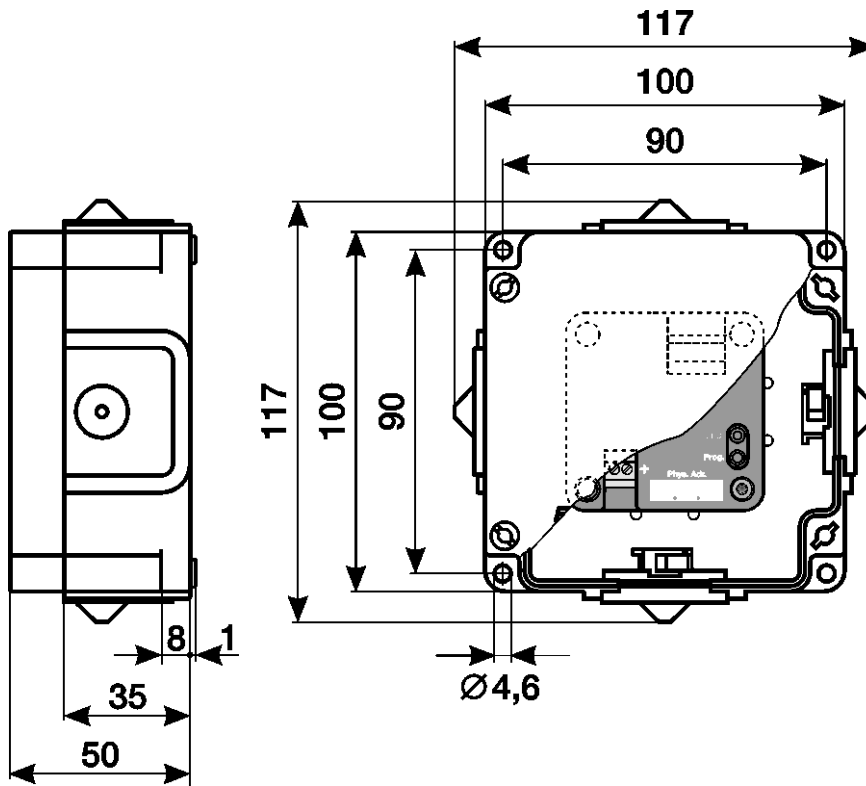

2CDC072013F0012

2.3 Mounting and installation

The AA/S 4.1.2 is a modular installation device for quick installation in the distribution board on 35 mm mounting rails to DIN EN 60 715.

The AA/A 2.1.2 is a surface mounted device.

The installation position can be selected as required.

It connects to the electrical supply using screw terminals and to the bus using the supplied bus connection terminal. The pin assignments are located on the housing.

The device is ready for operation once the bus voltage (for AA/A 2.1.2) or the auxiliary and bus voltages (for AA/S 4.1.2) have been applied.

The device must be accessible for operation, testing, visual inspection, maintenance and repair in compliance with DIN VDE 0100-520.

Commissioning requirement

In order to commission the device, a PC with ETS, as well as a connection to the ABB i-bus[®], e.g. via a KNX interface, is required.

The device is ready for operation after the bus voltage is applied. An auxiliary voltage is required (AA/S 4.1.2 only).

Important

- The maximum permissible current of a KNX line must not be exceeded.
- During planning and installation ensure that the KNX line is correctly dimensioned.
- The device has a maximum current draw of 12 mA.
- Do not feed the outputs with any external voltage. Connected components must be reliably isolated from other voltages.
- The 0 V terminals on the outputs are connected with each other internally.

Mounting and commissioning may be carried out only by electrical specialists. The applicable standards, directives, regulations and specifications for the country in question should be observed when planning and setting up electrical installations and security systems for intrusion and fire detection.

- Protect the device from damp, dirt and damage during transport, storage and operation.
- Only operate the device within the specified technical data!
- The device should only be operated in an enclosed housing (distribution board)!
- The voltage supply to the device must be switched off before mounting.



Danger

All poles must be disconnected when expanding or modifying the electrical connections.

Supplied state

The device is supplied with the physical address 15.15.255. The application is pre-installed. Therefore, all that is necessary is to load group addresses and parameters during commissioning.

The complete application can be reloaded if required. Downloads may take longer after a change of application or a discharge.

Assignment of the physical address

The assignment and programming of the physical address are carried out in ETS.

The device features a *Programming* button for assignment of the physical address. The red *Programming* LED lights up after the button has been pressed. It goes off as soon as ETS has assigned the physical address or the *Programming* button is pressed again.

Download response

Depending on the PC that is used, the progress bar for the download may take up to one and a half minutes to appear, due to the complexity of the device.

Cleaning

The voltage supply to the device must be switched off before cleaning. If devices become dirty, they can be cleaned using a dry cloth or a cloth dampened with a soapy solution. Do not use corrosive agents or solutions.





Maintenance

The device is maintenance-free. In the event of damage (e.g. during transport and/or storage), do not carry out any repairs.

2.4 Display elements

Indicator LEDs are located on the front of the device.

The response of the display elements is described in the following table:

LED	Function	Description
Programming button	Press	Assignment of the physical address
 Programming LED	ON	The LED comes on when the <i>Programming</i> button is pressed, in order to assign a physical address to the bus subscriber.
	OFF	The LED does not come on unless the <i>Programming</i> button is pressed.
 A...D status LED (AA/S 4.1.2 only)	ON	Channel output signal not 0
	OFF	Channel output signal is 0 or output is deactivated
	FLASHING	Channel output fault: e.g. current mode: load too high (idling) or voltage mode: load too low (short circuit) or output stays active and LED flashes if control variable is not reached
 KNX status LED (AA/S 4.1.2 only)	ON	KNX voltage on, device ok
	OFF	Bus voltage failure
 Power LED (AA/S 4.1.2 only)	ON	Auxiliary voltage present
	OFF	Auxiliary voltage not present

Note

For the LEDs to function, the device must be ready for operation.
This requires the KNX voltage to be on and the application to be running.

3 Commissioning

The Analogue Actuator is used to convert physical values (2 bytes, 4 bytes) or relative values (1 byte) into analog voltages (0...1 V, 0...5 V, 0...10 V, 1...10 V) or currents (0...20 mA, 4...20 mA). This enables HVAC components such as ventilation flap or other device actuators to be integrated into the KNX system.

The parameter *Type of output* can be used separately to select the required voltage or current signal (not applicable to AA/A). Activating an output launches a display of additional parameters and group objects in ETS. Active outputs have a group object *Input value*, a group object *Status Actual value* and other group objects depending on the output parameters.

The required input format (1...4 bytes) and how the output reacts to a reset, bus voltage recovery, etc., can be specified for each active output.

There are other parameters that enable the use of forced operation objects to raise actuation priority, monitor input objects for a period of time, and set a dimming function.

3.1 Overview

HVAC applications

The Analogue Actuator is suitable for actuating ventilation flaps, vents and frequency converters in HVAC applications.

A 0...10 V signal is normally used as a control variable for this (corresponding to, e.g., 0...100%).

This control signal can be used to open or close valves or flaps by activating a motor or frequency converter that moves the valve or flap in the relevant direction.

It can also be used to specify setpoints via the 0...10 V output, for example to set the target temperature for a boiler.

Example: Possible temperature range 30 °C to 80 °C; here, a 5 V signal would correspond to an output temperature of 55 °C.

The application allows you to create a characteristic, which means that the system can also control complex variables such as those for 6-way valves (attention, the Analogue Actuator has only one control value input!) or valves with an operating range of 2...10 V.

Lighting applications

An Analogue Actuator, especially the 0...10 V interface, can also be used as a control signal for a lighting circuit (e.g. LED), to control brightness or lamp/LED color.

When the actuator is used as a 1...10 V output it can also actuate ballasts of up to 4 mA (per output).

3.2 Parameters

The ETS Engineering Tool Software is used to parameterize the device.

In ETS, the application is located in the *Catalogs* window under *Manufacturers/ABB/Output/Analog Output*.

The following chapters describe the device parameters using the parameter windows. Parameter windows are structured dynamically so that further parameters may be enabled depending on the parameterization and the function.

The default values of the parameters are underlined, e.g.:

Options: Yes
 No

Note
The device has several channels. However, as the functions for all the channels are identical, all the descriptive examples show the functions for Channel A.

Note
The screenshots showing the AA/S 4.1.2 application in ETS 4 are representative of all devices.

3.2.1 Parameter window *General*

Higher-level parameters can be set in the parameter window *General*.

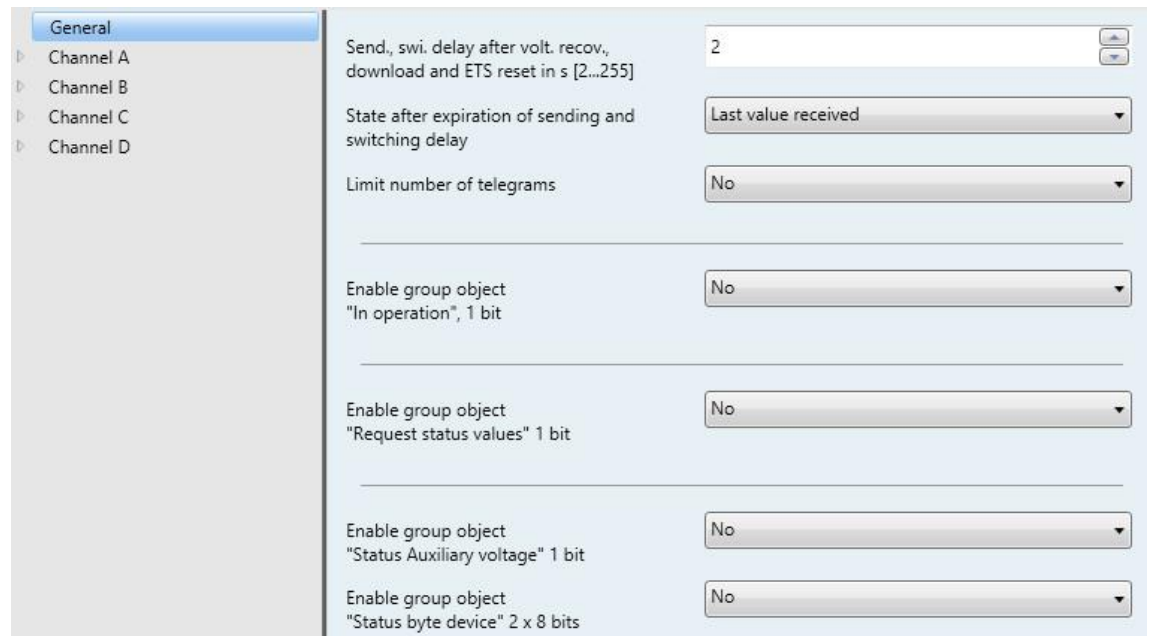

Parameter	Value
Send., swi. delay after volt. recov., download and ETS reset in s [2...255]	2
State after expiration of sending and switching delay	Last value received
Limit number of telegrams	No
Enable group object "In operation", 1 bit	No
Enable group object "Request status values" 1 bit	No
Enable group object "Status Auxiliary voltage" 1 bit	No
Enable group object "Status byte device" 2 x 8 bits	No

Send., swi. delay after volt. recov., download and ETS reset in s [2...255]

Options: 2...255

During the sending and switching delay, telegrams are only received. However, the telegrams are not processed and the outputs remain unchanged. No telegrams are sent on the bus.

After the sending and switching delay time, telegrams are sent and the state of the outputs is set to correspond to the parameterization or the group object values.

If group objects are read out via the bus during the sending and switching delay, e.g. by a visual display system, these requests are stored and a response is sent once the delay time has expired.

An initialization time of about two seconds is included in the delay time.

The initialization time is the time that the processor requires before it is ready to function.

How does the device react on bus voltage recovery?

After bus voltage recovery, the device always waits for the sending and switching delay time to expire before sending telegrams on the bus.

State after expiration of sending and switching delay

Options: Last value received
Ignore received values

- *Last value received*: During the sending and switching delay, the inputs and outputs continue reading. They send the current value after the delay has expired.
- *Ignore received values*: No new values are accepted during the sending and switching delay. The first value received continues to apply.

Limit number of telegrams

Options: No
Yes

This parameter limits the device-generated bus load. This limit relates to all telegrams sent by the device.

Selection of Yes option:

Dependent parameters:

Max. number of telegrams [1...255]

Options: 1...20...255

In period

Options: 50/100/200/500 ms...1/2/5/10/30 s...1 min

This parameter defines the number of telegrams sent by the device within a period. The telegrams are sent as quickly as possible at the start of a period.

Note

The device counts the number of telegrams sent within the parameterized period. As soon as the maximum number of sent telegrams is reached, no further telegrams are sent on the KNX until the end of the period. A new period commences at the end of the previous period. The telegram counter is reset to zero, and sending of telegrams is allowed again. The current group object value at the time of sending is always sent.

The first period (break time) is not predefined exactly. It can be between zero seconds and the parameterized time. The subsequent sending times correspond to the parameterized time.

Example:

Maximum number of sent telegrams = 5, period = 5 s. 20 telegrams are ready to send. The device immediately sends 5 telegrams. The next 5 telegrams are sent after a maximum of 5 seconds. From this point, a further 5 telegrams are sent on the KNX every 5 seconds.

Enable group object "Request status values" 1 bit

Options: Yes
 No

Linked group object: Request status values

This parameter enables a group object that can trigger sending for all device and channel status objects with a single 1-bit group object. The request can be made via object value 0, 1 or 0 or 1.

All status messages can be requested using this group object, provided the parameter *Send status values* is set to *After a change or request* in [Parameter window A: General](#), p.26.

- Yes: The group object is enabled.
- No: The group object is not enabled.

Selection of Yes option:

Dependent parameters:

Request with object value

Options: 0
 1
 0 or 1

- 0: Sending status messages is requested with the value 0.
- 1: Sending status messages is requested with the value 1.
- 0 or 1: Sending status messages is requested with the values 0 or 1.

Enable group object "Status Auxiliary voltage" 1 bit

Options: Yes
 No

Linked group object: Status Auxiliary voltage

Note

This parameter and its corresponding group object are not available in the *Analogue output 2f/** application of Analogue Actuator AA/A 2.1.2.

The group object indicates whether the auxiliary voltage (supply voltage) is present. If it fails, all outputs are deactivated but bus communication remains operational.

Note

If the auxiliary voltage fails, the group object sends the value 0.

- Yes: The group object is enabled.
- No: The group object is not enabled.

3.2.2 Parameter window A: General

This parameter window is used to define the general settings for a channel.

Note

The device has several channels. However, as the functions for all the channels are identical, all the descriptive examples show the functions for Channel A.

The screenshot shows the 'A: General' parameter window in the ABB i-bus KNX Commissioning software. The left sidebar contains a tree view with the following items: 'General', 'Channel A', 'A: General' (selected), 'Channel B', 'Channel C', and 'Channel D'. The main pane contains the following settings:

Type of output	0...10 V
Input format	1 byte [0...255] DPT 5.005
Create own characteristic	No
Definition of the output range: Input value for 0% output value	0
Input value for 100% output value	255
Enable function Dimming	No
Enable function 8-bit scene	No
Enable function Forced operation	No
Activate cyclical monitoring	No
Reaction on bus voltage failure or ETS programming	Retain current output value
Reaction on bus voltage recovery	As before bus voltage failure
Object value request on new start and bus voltage recovery	No
Send status values	On change

ABB i-bus[®] KNX Commissioning

Type of output

Options: Deactivated
 0...1 V
 0...5 V
 0...10 V
 1...10 V
 0...20 mA
 4...20 mA

Linked group object: Input value
 Status Actual value

This parameter defines the output type (current/voltage with upper and lower limits) or deactivates the output.

Note
Surface mounted device AA/A 2.1.2 does not feature the options for current.

Input format

Options: 1 byte [0...255] DPT 5.005
 1 byte [0...100] % DPT 5.001
 1 byte [-128...127] DPT 6.010
 2 bytes [0...65,535] DPT 7.001
 2 bytes [-32,768...32,767] DPT 8.001
 2 bytes (floating point) DPT 9.0XX
 4 bytes (IEEE float. point) DPT 14.0XX

Linked group object: Status Actual value

This parameter defines the input format. The available input range varies depending on the input format.

ABB i-bus[®] KNX Commissioning

Create own characteristic

Options: Yes
 No

- **Yes:** This opens a new parameter window, *A: Characteristic*, in which it is possible to specify a particular output progression based on the input signal by using a specific number of support points.
- **No:** No own characteristic specified.

Selection of Yes option:

Dependent parameters:

Parameterize supports and limits on the page "Characteristic"

For further information on setting the parameters, see [Parameter window A: Characteristic](#), p. 35.

Enable function Dimming

Options: Yes
 No

Linked group object: Switch
 Dimming
 Status Switch

- Yes: This opens a new parameter window, *A: Dimming*.
- No: The function is not available.

For further information on setting the parameters, see [Parameter window A: Dimming](#), p. 41.

Enable function 8-bit scene

Options: Yes
 No

Linked group object: 8-bit scene

Activating this parameter allows you to assign scenes to specific output values.

- Yes: This opens a new parameter window, *A: Scenes*.
- No: The function is not available.

For further information on setting the parameters, see [Parameter window A: Scenes](#), p. 43.

Enable function Forced operation

Options: Yes
 No

Activating this parameter allows you to create two forced operations.

- Yes: This opens a new parameter window, *A: Forced operation*.
- No: The function is not available.

For further information on setting the parameters, see [Parameter window A: Forced operation](#), p. 45.

Activate cyclical monitoring

Options: No
 Object Input value
 Object Forced operation
 Object Input value and object Forced operation

Linked group object: Alarm

This parameter enables you to monitor one or both objects when they receive a value, to detect failure on the device sending the value. If the monitoring time is exceeded, an Alarm object is sent on the bus. In addition, there is a predefined output value that is activated if the time is exceeded.

- *No*: No monitoring takes place.
- *Object Input value*: The system monitors whether the group object *Input value* has received a value within the defined time.
- *Object Forced operation*: The system monitors whether one of the group objects *Forced operation* has received a value within the defined time.
- *Object Input value and object Forced operation*: The system monitors whether one of the group objects *Forced operation* or a group object *Input value* has received a value within the defined time.

Note

In case of an alarm, the object is sent with value 1.

Dependent parameters:

Time interval for cyclical monitoring in s [1...65,535]

Options: 1...180...65,635

This parameter defines the time within which a new signal must be received. When it expires, the Alarm object is automatically sent,

Output after exceeding the monitoring time in % [0...100]

Options: 0...100

This parameter defines the output value that applies if the monitoring time is exceeded.

Note

If you choose to use cyclical monitoring for the group object *Forced operation*, this object must also be activated and parameterized, otherwise monitoring will switch on and you will not be able to switch it off.

Note

If forced operation is active and cyclical monitoring is triggered, the output value does not change. Forced operation always takes priority.

ABB i-bus[®] KNX Commissioning

Reaction on bus voltage recovery

Options: As before bus voltage failure
 Adopt user-defined output value

This parameter determines how the output reacts after bus voltage recovery.

- *As before bus voltage failure*: the value before the bus voltage failure continues to apply
- *Adopt user-defined output value*: A user-defined value may be entered.

Selection of the option *Adopt user-defined output value*:

Dependent parameters:

Output in % [0...100]

Options: 0...100

This parameter specifies the output value that applies after bus voltage recovery.

Attention

The value set here is affected by the characteristic!

If the characteristic defines the highest and lowest possible input values, the output range that can be actuated will be limited.

Example:

- 2-byte input format [DPT 9.0xx]; the characteristic is defined as 0 = 0 V and 1,000 = 10 V.
This results in the following assignment:
0 % = 0 V
50 % = 0 V
51 % = 0.2 V
75 % = 5 V
100 % = 10 V

See also the example in [3.2.3 Parameter window A: Characteristic](#), p. 36.

Object value request on new start and bus voltage recovery

Options: Yes
 No

This parameter defines whether an object value request (Value Read) is sent on the bus after a device restart and after bus voltage recovery.

The request includes the channel's group objects *Input value* and *Switch*.

Send status values

Options: No, update only
 On change
 After a change or request
 Cyclically and on change

- *No, update only*: The status is updated but not sent.
- *On change*: The status is sent when a change occurs.
- *After a change or request*: The status is sent when a change or request occurs.
- *Cyclically and on change*: The status is sent cyclically and when a change occurs.

Selection of option *Cyclically and on change*:

Dependent parameters:

Sending cycle time in s [1...65,535]

Options: 1...600...65,535

This parameter allows all status values connected with the channel to be sent cyclically within the set time range.

The group objects sent are *Voltage/Current output value*, *Status Actual value*, *Status Switch* and *Fault at output*.

Note

This setting is made in the parameter window *General* for all channels, i.e. if the parameter *Enable group object "Request status values" 1 bit* is set to *Yes*, then only the two status bytes are sent. If the channel's parameter *Send status values* is set to the option *After a change or request*, then the channel status (output value) is **also** sent when a request (or change) occurs. If the internal value that corresponds to the output value changes due to an external value change, a forced operation or a scene recall, this constitutes a change.

ABB i-bus[®] KNX Commissioning

3.2.3 Parameter window A: Characteristic

This parameter window is shown if the corresponding function was enabled in [Parameter window A: General](#), p. 26.

Using the function *Characteristic* you can specify a particular reaction for each output by setting up your own characteristic. You can enter between 2 and 11 support points for this. Each support point assigns a specific output value to an input value. The reaction between these values will be linear. Along with the characteristic you can also prescribe a minimum or maximum output value limit by parameterizing the minimum and maximum values of the characteristic accordingly.

General

- Channel A
 - A: General
 - A: Characteristic**
 - Channel B
 - Channel C
 - Channel D

No of support points: 2

Attention! Observe selected input format!

Charact. affects device scene and voltage recovery reaction. Check manual.

Input values must be specified in ascending order.

Support 1 input value, value between [0...255]: 0

Support 1 output value, value in mV [0...10,000]: 0

Support 2 input value, value between [0...255]: 0

Support 2 output value, value in mV [0...10,000]: 0

No of support points

Options: 2
3
4
5
6
7
8
9
10
11

This parameter enables you to select the number of support points to create the characteristic.

Attention! Observe selected input format!

Charact. affects device scene and voltage recovery reaction. Check manual.

Input values must be specified in ascending order.

Note

If the input values are not specified in ascending order, the device sorts them into the correct order:

Note

It is not allowed to assign more than one output value to one input value, as this could result in failures in the processing of the characteristic.

Example:

Values before sorting:

Value	Input value	Output value [V]
1	10 %	1
2	30 %	3
3	40 %	1
4	20 %	3.5
5	60 %	3.5
6	50 %	3
7	90 %	1.75
8	80 %	2.5
9	70 %	3



ABB i-bus[®] KNX Commissioning

Values after sorting:

Value	Input value	Output value [V]
1	10 %	1
2	20 %	3.5
3	30 %	3
4	40 %	1
5	50 %	3
6	60 %	3.5
7	70 %	3
8	80 %	2.5
9	90 %	1.75

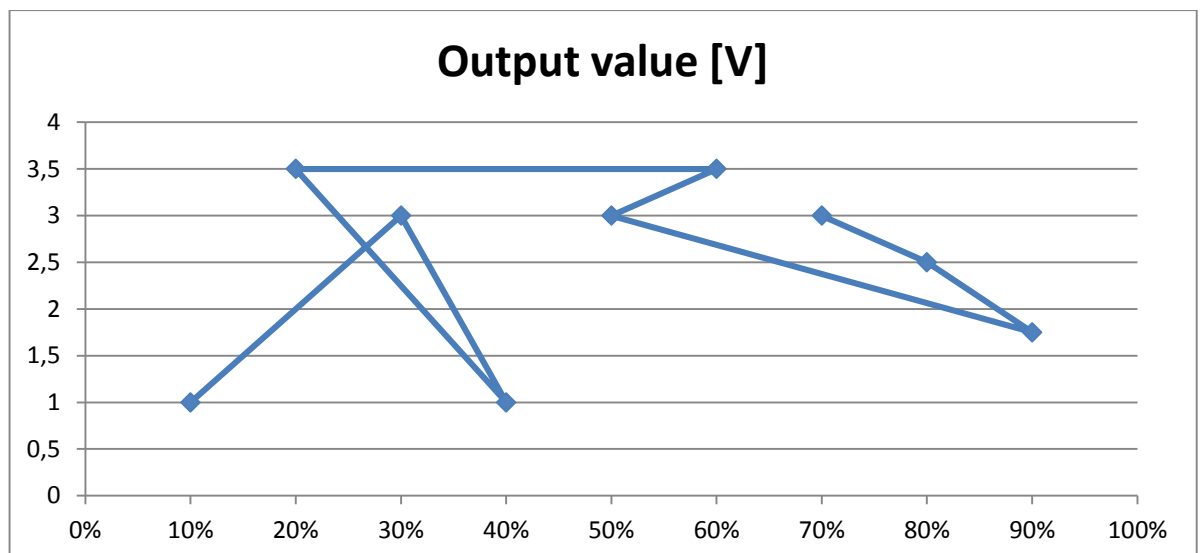
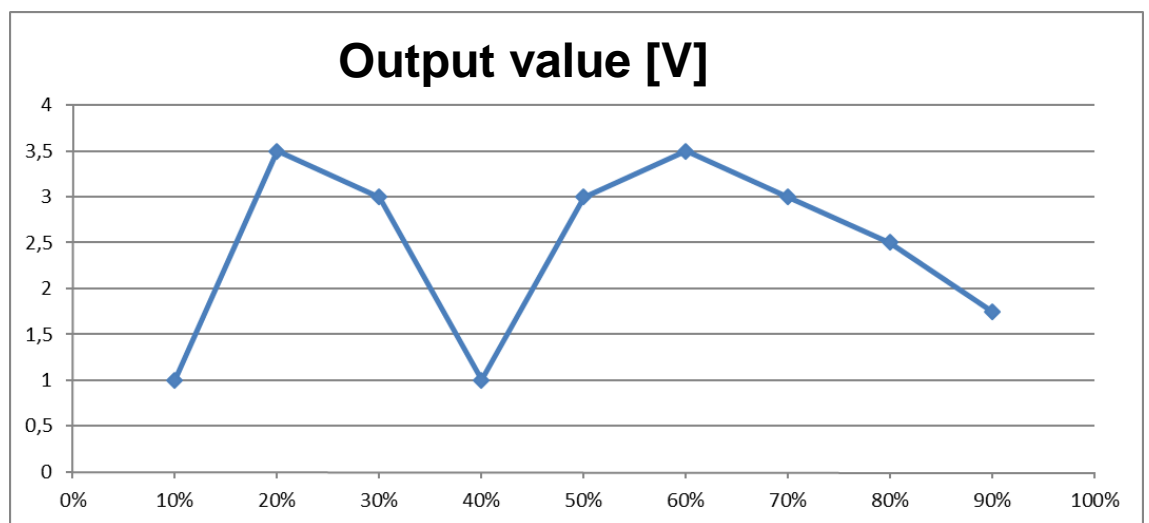

The input and output values available depend on the input format selected in [Parameter window A: General](#), p. 26.

Note

Using a characteristic to set limits can result in differences between the values entered and the values output.

For example, if you enter 95 % as an input value, the system will reset it to the nearest valid value (90 %; 1.75 V). As the output value 1.75 V appears four times, the lowest value is adopted as the return value (group object *Status Actual value*), in this case 13 %, and written to the output object.

The example below shows how a characteristic is used to limit the input range.

The screenshots show the settings selected in order to do this.

Settings in Parameter window A: Characteristic:

The screenshot shows the 'Characteristic' settings for Channel A. The left sidebar lists 'General', 'Channel A', 'A: General', 'A: Characteristic', 'Channel B', 'Channel C', and 'Channel D'. The main area contains the following settings:

- Type of output: 0...10 V
- Input format: 1 byte [0...255] DPT 5.005
- Create own characteristic: Yes
- Parameterize supports and limits on the page "Characteristic": (checkbox, checked)

Settings in Parameter window A: General:

The screenshot shows the 'General' settings for Channel A. The left sidebar lists 'General', 'Channel A', 'A: General', 'A: Characteristic', 'Channel B', 'Channel C', and 'Channel D'. The main area contains the following settings:

- No of support points: 2
- Attention! Observe selected input format!
- Charact. affects device scene and voltage recovery reaction. Check manual.
- Input values must be specified in ascending order.
- Support 1 input value, value between [-1,000...1,000]: 00,00
- Support 1 output value, value in mV [0...10,000]: 0
- Support 2 input value, value between [-1,000...1,000]: 00,00
- Support 2 output value, value in mV [0...10,000]: 0

Note

If you create your own characteristic, the percentages entered for *Reaction on bus voltage recovery* and *Scenes* must always be considered for the whole range of the selected input format.

ABB i-bus® KNX Commissioning

The table below shows an example with the different input formats for output type 0...10 V, with those values highlighted in orange that will change the output value.

Input value [%]	Input format							Voltage [V]
	DPT 5.001	DPT 5.005	DPT 6.010	DPT 7.001	DPT 8.001	DPT 9.0xx	DPT 14.0xx	
0 %	0	0	-128	0	-32,768	-1000.00	-1,000.0000	0
50 %	50	128	0	32,768	0	0.00	0	0
60 %	60	153	25	39,321	6,553	200.00	200.0000	10
100 %	100	255	127	65,535	32,767	1000.00	1,000.0000	10

The example below is for DPT 9.0xx.

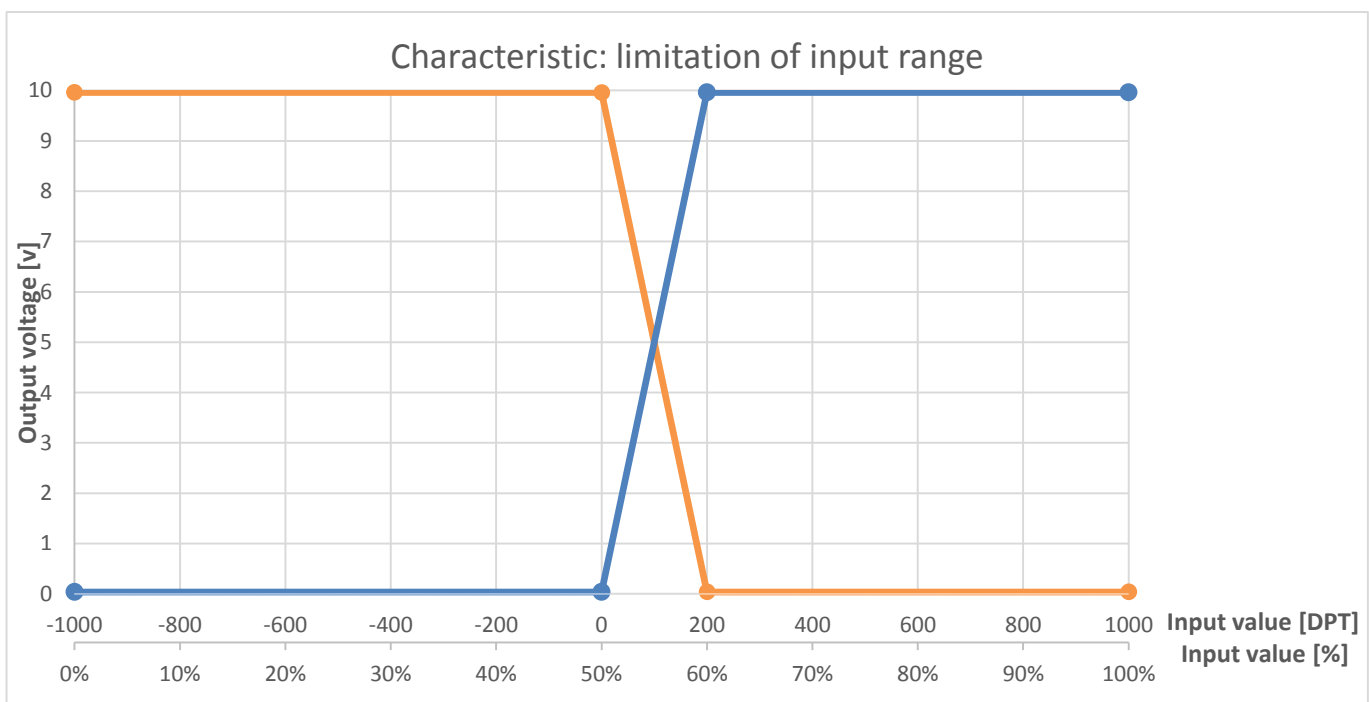

The assignment is as follows:

Input value [%]	0	...	25	...	50	...	55	...	60	...	75	...	100
Input value [DPT]	-1000	...	-500	...	0	...	100	...	200	...	500	...	1000
Resulting output value [V]	0	0	0	0	0	...	5	...	10	10	10	10	10
Resulting output value [V] inverted characteristic	10	10	10	10	10	...	5	...	0	0	0	0	0

The table shows the reaction of the output with the above characteristic, depending on the input values entered (via group object) or set (via parameters).

The valid value range that may be used with the functions *Scene* and *Reaction on bus voltage recovery* is highlighted in orange.

ABB i-bus[®] KNX Commissioning

3.2.4 Parameter window A: Dimming

This parameter window is shown if the corresponding function was enabled in [Parameter window A: General](#), p. 26.

The function *Dimming* enables you to use additional options that are primarily used to dim output voltages. To set these additional options, use the parameters below.

If the function *Characteristic* is in use at the same time, certain values are also dimmed by means of the parameterized characteristic.

In addition, when the function *Dimming* is in use, it activates the 4-bit input group object *Dimming* and the 1-bit input group object *Switch* plus the 1-bit output group object *Status Switch*.

General		
Channel A		
A: General	Rel. dimming speed for [0...100%] and input value in s [0...255]	5
A: Dimming	Switch on at	Last output value
Channel B	Dimming speed for [0...100%] while switching in s [0...255]	0
Channel C		
Channel D		

Rel. dimming speed for [0...100] and input value in s [0...255]

Options: 0...5...255

The value selected indicates the dimming speed required to dim from 0 to 100 %. If dimming between other values, the duration is calculated based on this value.

Note

The dimming range can be limited only absolutely using the characteristics, whereby the upper and lower limits serve as the upper and lower dimming limits.

Note

The lower dimming limit should be set to a value at which the lamps can still be operated. Some lamps switch off or start to flicker at a value below around 10% (please observe the manufacturer's technical data).

Switch on at

Options: User-defined value
 Last output value

This parameter allows you to choose a switch-on value of between 0...100 % or to switch back on at the last output value before switching off.

In order to switch on, the group object that switches the load (e.g. via Switch Actuator SA/S) is also linked to the group object *Switch* for the associated Analogue Actuator channel. Alternatively, the switch actuator status response (*Status Switch*) can be linked with the input object *Switch* of the Analogue Actuator. Or in reverse order, the group object *Status Switch* of the Analogue Actuator can be linked with the group object *Switch* of the Switch Actuator.

Selection of the option *User-defined value*:

Dependent parameters:

User-defined value in defined input range in % [0...100]

Options: 0...80...100

This can be entered in 1 % increments.

Note

After a device download, the upper dimming limit is used as the last brightness value.

Dimming speed for [0...100%] while switching in s [0...255]

Options: 0...100

The value selected indicates the speed required to switch the lamp from 0 to 100 %. If switching between other values, the duration is calculated based on this value.

Note

The group object *Status Switch* will change the status from "Off" to "On" if the input value is higher than the smallest defined input value.

This will also apply with the *Characteristic* function if an output value higher than the smallest physical value has been assigned to the smallest input value.

ABB i-bus[®] KNX Commissioning

3.2.5 Parameter window A: Scenes

This parameter window is shown if the corresponding function is enabled in [Parameter window A: General](#), p. 26.

The function *Scenes* can be used for direct activation of certain predefined input values (as a percentage and depending on the output range). These output values are then used to output the associated output value (according to the characteristic, if applicable) at the output.

Note
Scene values are always affected by the characteristic.

General

- Channel A
 - A: General
 - A: Scenes**
- Channel B
- Channel C
- Channel D

Overwrite scenes on download: Yes

Attention! Observe input form, upp./ low. limits. See ch. A or A: Charact.

Assignment 1 to scene number (No. 1...64, 0 = no assignment): 0

Assignment 1 input value in % [0...100]: 0

Assignment 2 to scene number (No. 1...64, 0 = no assignment): 0

Assignment 2 input value in % [0...100]: 0

Assignment 3 to scene number (No. 1...64, 0 = no assignment): 0

Assignment 3 input value in % [0...100]: 0

Assignment 4 to scene number (No. 1...64, 0 = no assignment): 0

Assignment 4 input value in % [0...100]: 0

Assignment 5 to scene number (No. 1...64, 0 = no assignment): 0

Assignment 5 input value in % [0...100]: 0

Overwrite scenes on download

Options: Yes
No

This parameter specifies whether the scenes should be overwritten as well after a device download.

**Attention! Observe input form., upp./
low. limits. See ch. A or A: Charact.**

< --- Note

Assignment X to scene number (No. 1...64, 0 = no assignment)

Options: 0...64

This parameter specifies which scene number (1...64) assignment X (X = 1...16) is assigned to.

Note

If a scene assignment is duplicated, the first assignment in the assignment table is output (in ascending order).

Assignment X input value in % [0...100]

Options: 0...100

This parameter specifies the input value that the system should approach when scene X (X = 1...16) is switched on. The setting is 0...100 % of the input range, depending on the upper and lower limits selected.

The scene value is written to the group object *Status Actual value*.

Important

The input format set in [Parameter window A: General](#), p. 26, and the upper and lower limits must be observed. If a value outside this range is entered, it will automatically be limited to the nearest valid value.

ABB i-bus[®] KNX Commissioning

3.2.6 Parameter window A: Forced operation

This parameter window is shown if the corresponding function was enabled in [Parameter window A: General](#), p. 26.

The function *Forced operation* allows you to adopt a specific output value that overrides the input value, by sending a 1- or 2-bit command that applies predefined parameters. This output value can also be exited again only after withdrawal of the forced operation command.

The difference between 1- and 2 bit-forced operations is that the latter allows you to assign two different values: one for the forced Off status, e.g. 0 V, and another for the forced On status, e.g. 10 V.

Forced operation 1 takes priority over forced operation 2. But both must be canceled in order to continue in normal mode.

Note

Forced operation is not affected by the characteristic. It is output directly.

The screenshot shows a software interface for configuring 'A: Forced operation'. On the left is a tree view with 'General', 'Channel A', 'A: General', 'A: Forced operation' (selected), 'Channel B', 'Channel C', and 'Channel D'. The main area is titled 'Attention! Observe output range' and contains three settings: 'Use forced operation 1' set to 'No', 'Use forced operation 2' set to 'No', and 'Output value after cancellation of forced operation' set to 'Current input value'. Each setting is accompanied by a dropdown menu.

Attention! Observe output range

< --- Note

Note

The output type set in [Parameter window A: General](#) (see p. 26) must be observed.

ABB i-bus[®] KNX Commissioning

Use forced operation 2

Options: No
 Forced operation objects, 1 bit; 0 active
 Forced operation objects, 1 bit; 1 active
 Forced operation objects, 2 bits

Linked group object: Forced operation 2, 1 bit
 Forced operation 2, 2 bits

Depending on the selected type of forced operation, activating forced operation enables the corresponding parameters below for setting a forced operation.

Selection of option *Forced operation objects, 1 bit*:

Output value with forced operat. 2 in % of output range [0...100]

Options: 0...100

This parameter specifies the output value when forced operation 2 is activated.

Selection of option *Forced operation objects, 2 bits*:

Output value with forced operat. 2 ON in % of output range [0...100]

Options: 0...100

This parameter specifies the output value when forced operation 2 ON is activated.

Output value with forced operat. 2 OFF in % of output range [0...100]

Options: 0...100

This parameter specifies the output value when forced operation 2 OFF is activated.

Note
The reaction and parameters of forced operation 2 are identical to those for forced operation 1. However, forced operation 1 takes priority.

Output value after cancellation of forced operation

Options: Value before forced operation
 Current input value
 Retain forced operation value

This parameter determines the reaction when forced operation is canceled. This will apply once there is no longer an active forced operation.

Note
The specified reaction applies to forced operations 1 and 2.

- *Value before forced operation*: The last value received before forced operation applies. In the interim the input object accepts no new input values, but sends an acknowledgment telegram anyway. Once forced operation has been deactivated, the last value before activating forced operation applies, and the input object starts accepting new values again.
- *Current input value*: The value received during or before forced operation is retained until a new input value is received. During forced operation, the input object can still be written. Once forced operation is canceled, the existing value in the input object applies.
- *Retain forced operation value*: The value activated by forced operation is retained. Once a new input value is received, it is activated.

ABB i-bus[®] KNX Commissioning

Priorities:

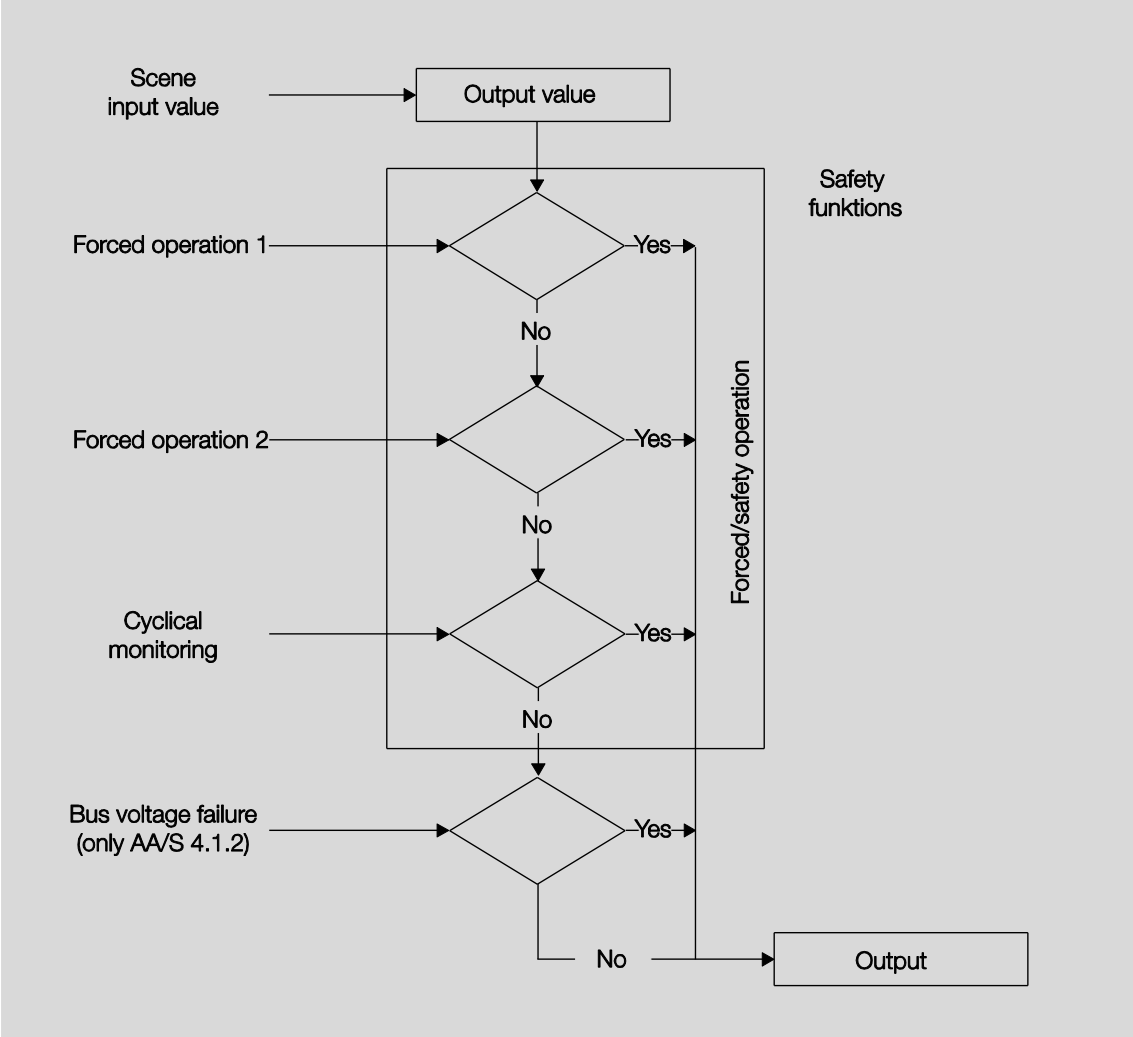

3.3 Group objects

3.3.1 Summary of group objects

Note

The overview includes the group objects for the 4-fold Analogue Actuator AA/S 4.1.2. Accordingly, the 2-fold Analogue Actuator AA/A 2.1.2 only features channels A and B.

No.	Function	Name	Data Point Type (DPT)	Length	Flags				
					C	R	W	T	U
0	Request status values	General	1.017	1 bit	x		x		x
1	In operation	General	1.002	1 bit	x	x		x	
2	Status Auxiliary voltage (not applicable to AA/A 2.1.2)	General	1.002	1 bit	x	x		x	
3	Status byte channel A/B	General	Non DPT		x	x		x	
4	Status byte channel C/D (not applicable to AA/A 2.1.2)	General	Non DPT		x	x		x	
5...9	Not assigned								
10	Status Actual value	Channel A	Variable	Variable	x	x		x	
11	Status Switch	Channel A	1.001	1 bit	x	x		x	
12	Input value	Channel A	Variable	Variable	x		x		x
13	Switch	Channel A	1.001	1 bit	x		x		
14	Dimming	Channel A	3.007	4 bits	x		x		
15	Forced operation 1, 1 bit	Channel A	1.002	1 bit	x		x		x
16	Forced operation 1, 2 bits	Channel A	2.001	2 bits	x		x		x
17	Forced operation 2, 1 bit	Channel A	1.002	1 bit	x		x		x
18	Forced operation 2, 2 bits	Channel A	2.001	2 bits	x		x		x
19	8-bit scene	Channel A	18.001	1 byte	x		x		x
20	Alarm	Channel A	1.005	1 bit	x	x		x	
21	Fault at output	Channel A	1.005	1 bit	x	x		x	
22	Voltage output value	Channel A	9.020	2 bytes	x	x		x	
	Current output value		9.021	2 bytes					
23...29	Not assigned								
30	Status Actual value	Channel B	Variable	Variable	x	x		x	
31	Status Switch	Channel B	1.001	1 bit	x	x		x	
32	Input value	Channel B	Variable	Variable	x		x		x
33	Switch	Channel B	1.001	1 bit	x		x		
34	Dimming	Channel B	3.007	4 bits	x		x		
35	Forced operation 1, 1 bit	Channel B	1.002	1 bit	x		x		x
36	Forced operation 1, 2 bits	Channel B	2.001	2 bits	x		x		x
37	Forced operation 2, 1 bit	Channel B	1.002	1 bit	x		x		x
38	Forced operation 2, 2 bits	Channel B	2.001	2 bits	x		x		x
39	8-bit scene	Channel B	18.001	1 byte	x		x		x
40	Alarm	Channel B	1.005	1 bit	x	x		x	
41	Fault at output	Channel B	1.005	1 bit	x	x		x	
42	Voltage output value	Channel B	9.020	2 bytes	x	x		x	
	Current output value		9.021	2 bytes					
43...49	Not assigned								

ABB i-bus[®] KNX Commissioning

No.	Function	Name	Data Point Type (DPT)	Length	Flags				
					C	R	W	T	U
50	Status Actual value	Channel C	Variable	Variable	x	x		x	
51	Status Switch	Channel C	1.001	1 bit	x	x		x	
52	Input value	Channel C	Variable	Variable	x		x		x
53	Switch	Channel C	1.001	1 bit	x		x		
54	Dimming	Channel C	3.007	4 bits	x		x		
55	Forced operation 1, 1 bit	Channel C	1.002	1 bit	x		x		x
56	Forced operation 1, 2 bits	Channel C	2.001	2 bits	x		x		x
57	Forced operation 2, 1 bit	Channel C	1.002	1 bit	x		x		x
58	Forced operation 2, 2 bits	Channel C	2.001	2 bits	x		x		x
59	8-bit scene	Channel C	18.001	1 byte	x		x		x
60	Alarm	Channel C	1.005	1 bit	x	x		x	
61	Fault at output	Channel C	1.005	1 bit	x	x		x	
62	Voltage output value	Channel C	9.020	2 bytes	x	x		x	
	Current output value		9.021	2 bytes					
63...69	Not assigned								
70	Status Actual value	Channel D	Variable	Variable	x	x		x	
71	Status Switch	Channel D	1.001	1 bit	x	x		x	
72	Input value	Channel D	Variable	Variable	x		x		x
73	Switch	Channel D	1.001	1 bit	x		x		
74	Dimming	Channel D	3.007	4 bits	x		x		
75	Forced operation 1, 1 bit	Channel D	1.002	1 bit	x		x		x
76	Forced operation 1, 2 bits	Channel D	2.001	2 bits	x		x		x
77	Forced operation 2, 1 bit	Channel D	1.002	1 bit	x		x		x
78	Forced operation 2, 2 bits	Channel D	2.001	2 bits	x		x		x
79	8-bit scene	Channel D	18.001	1 byte	x		x		x
80	Alarm	Channel D	1.005	1 bit	x	x		x	
81	Fault at output	Channel D	1.005	1 bit	x	x		x	
82	Voltage output value	Channel D	9.020	2 bytes	x	x		x	
	Current output value		9.021	2 bytes					

3.3.2 Input objects

3.3.2.1 Group objects General

No.	Function	Object name	Data type	Flags
0	Request status values	General	1 bit DPT 1.017	C, W, U
<p>This parameter is enabled if the parameter <i>Enable group object "Request status values" 1 bit</i> in Parameter window General, p. 21, is set to <i>Yes</i>.</p> <p>If this group object receives a telegram with the value x (x = 0/1/0 or 1), all group objects <i>Status</i> are sent on the bus, provided that the parameter <i>Send status values</i> in Parameter window A: General, p. 26, is set to <i>On change</i> or <i>After a change or request</i> or <i>Cyclically and on change</i>.</p> <p>Option x = 1 produces the following function: Telegram value: 1 = All status messages are sent 0 = No reaction</p>				

3.3.2.2 Group objects Channel A

No.	Function	Object name	Data type	Flags																					
12	Input value	Channel A	Variable DPT variable	C, W, U																					
<p>This group object is enabled if there is an output type set in Parameter window A: General, p. 26. This then allows you to set the input format.</p> <p>The following values can be sent:</p> <table border="0"> <tr> <td>1-byte value [0...100] %</td> <td>DPT</td> <td>5.001</td> </tr> <tr> <td>1-byte value [0...+255]</td> <td>DPT</td> <td>5.005</td> </tr> <tr> <td>1-byte value [-128...+127]</td> <td>DPT</td> <td>6.010</td> </tr> <tr> <td>2-byte value [0...+65,535]</td> <td>DPT</td> <td>7.001</td> </tr> <tr> <td>2-byte value [-32,768...+32,767]</td> <td>DPT</td> <td>8.001</td> </tr> <tr> <td>2-byte value (floating point)</td> <td>DPT</td> <td>9.0xx</td> </tr> <tr> <td>4-byte value (IEEE float. point)</td> <td>DPT</td> <td>14.0xx</td> </tr> </table>					1-byte value [0...100] %	DPT	5.001	1-byte value [0...+255]	DPT	5.005	1-byte value [-128...+127]	DPT	6.010	2-byte value [0...+65,535]	DPT	7.001	2-byte value [-32,768...+32,767]	DPT	8.001	2-byte value (floating point)	DPT	9.0xx	4-byte value (IEEE float. point)	DPT	14.0xx
1-byte value [0...100] %	DPT	5.001																							
1-byte value [0...+255]	DPT	5.005																							
1-byte value [-128...+127]	DPT	6.010																							
2-byte value [0...+65,535]	DPT	7.001																							
2-byte value [-32,768...+32,767]	DPT	8.001																							
2-byte value (floating point)	DPT	9.0xx																							
4-byte value (IEEE float. point)	DPT	14.0xx																							
13	Switch	Channel A	1 bit DPT 1.001	C, R, T																					
<p>This group object is enabled if the parameter <i>Enable function Dimming</i> in Parameter window A: General, p. 26, is set to <i>Yes</i>.</p> <p>This group object switches the output on (100 % or parameterized brightness value) or off. It can, for example, be linked with the 1-bit group object of a dimmer button.</p> <p>If cyclical monitoring of the input value is active, the switching object is not monitored.</p>																									

ABB i-bus[®] KNX Commissioning

14	Dimming	Channel A	4 bits DPT 3.007	C, W
<p>This group object is enabled if the parameter <i>Enable function Dimming</i> in Parameter window A: General, p. 26, is set to Yes.</p> <p>This group object steplessly dims the output up or down, e.g. with a dimmer button. The dimming speed is adjustable. Switch-on and switch-off is also possible via relative dimming.</p> <p>If cyclical monitoring of the input value is active, the dimming object is not monitored.</p>				
15	Forced operation 1, 1 bit	Channel A	1 bit DPT 1.002	C, W, U
<p>This group object is enabled if the parameter <i>Enable function Forced operation</i> in Parameter window A: General, p. 26, is set to Yes.</p> <p>This group object allows you to adopt a specific output value that overrides the input values, by sending a 1- or 2-bit command that applies predefined parameters.</p> <p>This output value can also be exited again only after withdrawal of the forced-operation command.</p> <p>The difference between 1- and 2-bit forced operations is that the latter allows you to assign two different values: one for the forced Off status, e.g. 0 V, and another for the forced On status, e.g. 10 V.</p> <p>Forced operation 1 takes priority over forced operation 2. But both must be canceled in order to continue in normal mode.</p>				
16	Forced operation 1, 2 bits	Channel A	2 bits DPT 2.001	C, W, U
See group object 15				
17	Forced operation 2, 1 bit	Channel A	1 bit DPT 1.002	C, W, U
See group object 15				
18	Forced operation 2, 2 bits	Channel A	2 bits DPT 2.001	C, W, U
See group object 15				

19	8-bit scene	Channel A	1 byte DPT 18.001	C, W, U																																						
<p>This group object is enabled if the parameter <i>Enable function 8-bit scene</i> in Parameter window A: General, p. 26, is set to Yes.</p> <p>The function <i>Scenes</i> can be used for direct activation of certain predefined input values. These input values are then used to output the associated output value (according to the characteristic, if applicable) at the output.</p> <p>The telegram contains the number of the addressed scene, as well as the information on whether the scene is to be recalled or if the current output value is to be re-assigned to the scene.</p> <p>Telegram values (1 byte): M0SS SSSS (MSB) (LSB) M: 0 = Scene is recalled 1 = Scene is stored S: Scene number (1... 16: 0000 0000...0000 1111)</p> <table border="1" style="margin-left: auto; margin-right: auto;"> <thead> <tr> <th colspan="2">KNX 8-bit telegram value</th> <th rowspan="2">Meaning</th> </tr> <tr> <th>Decimal</th> <th>Hexadecimal</th> </tr> </thead> <tbody> <tr><td>00</td><td>00h</td><td></td></tr> <tr><td>01</td><td>01h</td><td></td></tr> <tr><td>02</td><td>02h</td><td></td></tr> <tr><td>...</td><td>...</td><td></td></tr> <tr><td>15</td><td>Fh</td><td></td></tr> <tr><td colspan="3"><hr/></td></tr> <tr><td>128</td><td>80h</td><td></td></tr> <tr><td>129</td><td>81h</td><td></td></tr> <tr><td>130</td><td>82h</td><td></td></tr> <tr><td>...</td><td>...</td><td></td></tr> <tr><td>143</td><td>8Fh</td><td></td></tr> </tbody> </table> <p>Other numeric values do not affect the group objects.</p>					KNX 8-bit telegram value		Meaning	Decimal	Hexadecimal	00	00h		01	01h		02	02h			15	Fh		<hr/>			128	80h		129	81h		130	82h			143	8Fh	
KNX 8-bit telegram value		Meaning																																								
Decimal	Hexadecimal																																									
00	00h																																									
01	01h																																									
02	02h																																									
...	...																																									
15	Fh																																									
<hr/>																																										
128	80h																																									
129	81h																																									
130	82h																																									
...	...																																									
143	8Fh																																									

3.3.2.3

Group objects Channel B, C and D

No.	Function	Object name	Data type	Flags
32...39	See group objects 12...29	Channel B		
52...59	See group objects 12...29	Channel C		
72...79	See group objects 12...29	Channel D		

ABB i-bus[®] KNX Commissioning

4	Status byte channel C/D (not applicable to AA/A 2.1.2)	General	Non DPT	C, R, T																								
<p>The status byte reflects the current status of channel C/D. Different statuses are indicated here, e.g.</p> <ul style="list-style-type: none"> • Status Channel C – forced operation active • Status Channel D – fault at output <p>Bit sequence: 76543210</p> <table style="width: 100%; border-collapse: collapse;"> <tr> <td style="width: 10%;">Bit 7:</td> <td style="width: 30%;">Not assigned</td> <td style="width: 60%;">Always 0</td> </tr> <tr> <td>Bit 6:</td> <td>Not assigned</td> <td>Always 0</td> </tr> <tr> <td>Bit 5:</td> <td>Channel C: Forced operation</td> <td>0: Forced operation is not active (channel C) 1: Forced operation is active (channel C)</td> </tr> <tr> <td>Bit 4:</td> <td>Channel C: Cyclical monitoring</td> <td>0: Cyclical monitoring is not active (channel C) 1: Cyclical monitoring is active (channel C)</td> </tr> <tr> <td>Bit 3:</td> <td>Channel C: Fault at output</td> <td>0: No fault at output (channel C) 1: Fault at output (channel C)</td> </tr> <tr> <td>Bit 2:</td> <td>Channel D: Forced operation</td> <td>0: Forced operation is not active (channel D) 1: Forced operation is active (channel D)</td> </tr> <tr> <td>Bit 1:</td> <td>Channel D: Cyclical monitoring</td> <td>0: Cyclical monitoring is not active (channel D) 1: Cyclical monitoring is active (channel D)</td> </tr> <tr> <td>Bit 0:</td> <td>Channel D: Fault at output</td> <td>0: No fault at output (channel D) 1: Fault at output (channel D)</td> </tr> </table> <p>For further information see: Value table of group object Status byte channel C/D, p. 61</p>					Bit 7:	Not assigned	Always 0	Bit 6:	Not assigned	Always 0	Bit 5:	Channel C: Forced operation	0: Forced operation is not active (channel C) 1: Forced operation is active (channel C)	Bit 4:	Channel C: Cyclical monitoring	0: Cyclical monitoring is not active (channel C) 1: Cyclical monitoring is active (channel C)	Bit 3:	Channel C: Fault at output	0: No fault at output (channel C) 1: Fault at output (channel C)	Bit 2:	Channel D: Forced operation	0: Forced operation is not active (channel D) 1: Forced operation is active (channel D)	Bit 1:	Channel D: Cyclical monitoring	0: Cyclical monitoring is not active (channel D) 1: Cyclical monitoring is active (channel D)	Bit 0:	Channel D: Fault at output	0: No fault at output (channel D) 1: Fault at output (channel D)
Bit 7:	Not assigned	Always 0																										
Bit 6:	Not assigned	Always 0																										
Bit 5:	Channel C: Forced operation	0: Forced operation is not active (channel C) 1: Forced operation is active (channel C)																										
Bit 4:	Channel C: Cyclical monitoring	0: Cyclical monitoring is not active (channel C) 1: Cyclical monitoring is active (channel C)																										
Bit 3:	Channel C: Fault at output	0: No fault at output (channel C) 1: Fault at output (channel C)																										
Bit 2:	Channel D: Forced operation	0: Forced operation is not active (channel D) 1: Forced operation is active (channel D)																										
Bit 1:	Channel D: Cyclical monitoring	0: Cyclical monitoring is not active (channel D) 1: Cyclical monitoring is active (channel D)																										
Bit 0:	Channel D: Fault at output	0: No fault at output (channel D) 1: Fault at output (channel D)																										

3.3.3.2

Group objects Channel A

No.	Function	Object name	Data type	Flags																					
10	Status Actual value	Channel A	Variable DPT variable	C, R, T																					
<p>This group object is always enabled if the parameter <i>Type of output</i> in Parameter window A: General, p. 26, is not deactivated.</p> <p>It reflects the status of the output (output value) in the form of the user-selected input value format.</p> <p>The following values can be sent:</p> <table border="0"> <tr> <td>1-byte value [0...100] %</td> <td>DPT</td> <td>5.001</td> </tr> <tr> <td>1-byte value [0...+255]</td> <td>DPT</td> <td>5.005</td> </tr> <tr> <td>1-byte value [-128...+127]</td> <td>DPT</td> <td>6.010</td> </tr> <tr> <td>2-byte value [0...+65,535]</td> <td>DPT</td> <td>7.001</td> </tr> <tr> <td>2-byte value [-32,768...+32,767]</td> <td>DPT</td> <td>8.001</td> </tr> <tr> <td>2-byte value (floating point)</td> <td>DPT</td> <td>9.0xx</td> </tr> <tr> <td>4-byte value (IEEE float. point)</td> <td>DPT</td> <td>14.0xx</td> </tr> </table>					1-byte value [0...100] %	DPT	5.001	1-byte value [0...+255]	DPT	5.005	1-byte value [-128...+127]	DPT	6.010	2-byte value [0...+65,535]	DPT	7.001	2-byte value [-32,768...+32,767]	DPT	8.001	2-byte value (floating point)	DPT	9.0xx	4-byte value (IEEE float. point)	DPT	14.0xx
1-byte value [0...100] %	DPT	5.001																							
1-byte value [0...+255]	DPT	5.005																							
1-byte value [-128...+127]	DPT	6.010																							
2-byte value [0...+65,535]	DPT	7.001																							
2-byte value [-32,768...+32,767]	DPT	8.001																							
2-byte value (floating point)	DPT	9.0xx																							
4-byte value (IEEE float. point)	DPT	14.0xx																							
11	Status Switch	Channel A	1 bit DPT 1.001	C, R, T																					
<p>This group object is enabled if the parameter <i>Enable function Dimming</i> in Parameter window A: General, p. 26, is set to <i>Yes</i>.</p> <p>For the group object to be sent, the parameter <i>Send status values</i> in Parameter window A: General, p. 26, must be set to <i>On change</i>.</p> <p>It shows whether the input value has a higher value than the lowest threshold in the defined input range. The value is set to "On" (1) if a new value is written via the group object <i>Input value</i>, or if the output is switched on using the object <i>Dimming</i>, or if the output is switched on using the object <i>Switch</i>.</p>																									
20	Alarm	Channel A	1 bit DPT 1.005	C, R, T																					
<p>This group object is enabled unless the parameter <i>Activate cyclical</i> parameter in Parameter window A: General, p. 26, is set to <i>No</i>.</p> <p>It shows whether the monitoring time for cyclical monitoring has expired and if the output has therefore been switched to the value set for this eventuality.</p> <p>Telegram value: 0 = Cyclical monitoring time has not been exceeded 1 = Cyclical monitoring time has been exceeded</p>																									
21	Fault at output	Channel A	1 bit DPT 1.005	C, R, T																					
<p>This group object is enabled unless the parameter <i>Type of output</i> in Parameter window A: General, p. 26, is deactivated.</p> <p>It shows whether there is a fault at the output.</p> <p>Telegram value: 0 = No fault at output 1 = Fault at output</p>																									
22	Voltage output value Current output value	Channel A	2 bytes DPT 9.02x	C, R, T																					
<p>This group object is enabled unless the parameter <i>Type of output</i> in Parameter window A: General, p. 26, is deactivated.</p> <p>Depending on the output type (voltage or current) the DPT is set accordingly: voltage, DPT 9.020/current, DPT 9.021.</p> <p>The group object contains the physical output value for the channel present at the output.</p>																									

3.3.3.3 Group objects Channel B, C and D

No.	Function	Object name	Data type	Flags
30...31	See group objects 10...11	Channel B		
40...41	See group objects 20...21	Channel B		
50...51	See group objects 10...11	Channel C		
60...61	See group objects 20...21	Channel C		
70...71	See group objects 10...11	Channel D		
80...81	See group objects 20...21	Channel D		

A Appendix

A.1 Scope of delivery

The device is supplied together with the following components. Please check the items received using the following list:

AA/S 4.1.2

- 1 pcs. AA/S 4.1.2 Analogue Actuator, 4-fold, MDRC
- 1 pcs. installation and operating instructions

AA/A 2.1.2

- 1 pcs. AA/A 2.1.2 Analogue Actuator, 2-fold, SM
- 1 pcs. installation and operating instructions
- 1 pcs. bus connection terminal (red/black)
- 1 pcs. output connection terminal
- 4 pcs. cable ties for strain relief
- 2 pcs. blanking plug No. 1, opened, GHQ5006611P1
- 1 pack with 4 x screws and 4 x S6 dowels, 2CDG 924 002 B001

Attention

Degree of protection IP54 can be guaranteed only if the supplied blanking plugs are used.
If the plugs are not used, condensation and/or water can penetrate the housing and damage the device.

A.4 Ordering details

Short description	Description	Order No.	bbn 40 16779 EAN	Weight 1 pcs. [kg]	Packaging [pcs.]
AA/S 4.1.2	Analogue Actuator, 4-fold, MDRC, 0–10 V, 0–20 mA	2CDG110202R0011	4016779962377	0.19	1
AA/A 2.1.2	Analogue Actuator, 2-fold, SM, 0–10 V	2CDG110203R0011	4016779954075	0.26	1

Notes

Notes

Contact us

ABB STOTZ-KONTAKT GmbH

Eppelheimer Strasse 82
69123 Heidelberg, Germany
Phone: +49 (0)6221 701 607
Fax: +49 (0)6221 701 724
e-mail: knx.marketing@de.abb.com

Further information and local contacts:
www.abb.com/knx

Note:

We reserve the right to make technical changes or modify the contents of this document without prior notice.

The agreed properties are definitive for any orders placed. ABB AG does not accept any responsibility whatsoever for potential errors or possible lack of information in this document.

We reserve all rights in this document and in the subject matter and illustrations contained therein. Reproduction, transfer to third parties or processing of the content – including sections thereof – is not permitted without prior expressed written permission from ABB AG.

Copyright© 2016 ABB
All rights reserved